

NEW ITEMS // April 2023

111112 Tail Light Set With Trim* Pair / Wbox

111113 Tail Light Set Without Trim Pair / Wbox

LED Sequential Tail Light (Pair)

1973-1987 Chevy & GMC Truck

- #111112 set includes L/H #110843 & R/H #110844 pair pre-packed in one box for shipping
- #111113 set includes L/H #CTL7387LED-L and R/H #CTL7387LED-R pair pre-packed in one box for shipping
- 56 super bright red LED tail light w/ 12 LED white back-up light
- Quality stamped aluminum trim w/ clear anodizing (#111112 only)
- Features sequential operation with brake attention feature, and selector switch to turn off if desired
- Special tail light mounting base plate included
- Electronics completely sealed in epoxy to resist corrosion and moisture
- LED compatible flasher required for proper operation, item #90652 or #90649
- Modification required to internal bracket on Suburban models

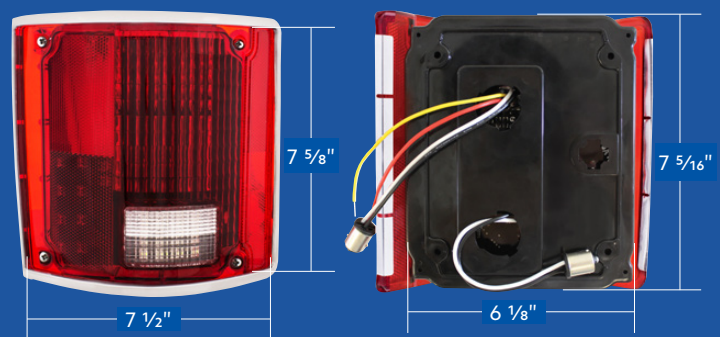
T 866.327.5288 | F 888.986.6088 | UPcarparts.com

17 Amber LED Front Parking Lights With SS Trim - Amber Lens (Pair)

1973-1980 Chevy & GMC Truck

- Set includes L/H #110885 & R/H #110886 pair pre-packed in one box for shipping
- High quality injection molded polycarbonate lens
- Fully epoxy sealed electronics to resist corrosion and moisture
- Features 17 bright SMD type amber LEDs
- Beautiful stainless steel trim
- Dual function with parking light & bright turn signal
- Easy electrical connection w/ 1157 plug, no modification to vehicle
- Some applications may require the indexing tab to be removed
- LED compatible flasher required for proper operation, item #90652 or #90649
- DOT/SAE, FMVSS 108

111108 | Amber Lens

Pair / Wbox

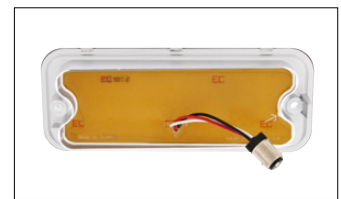
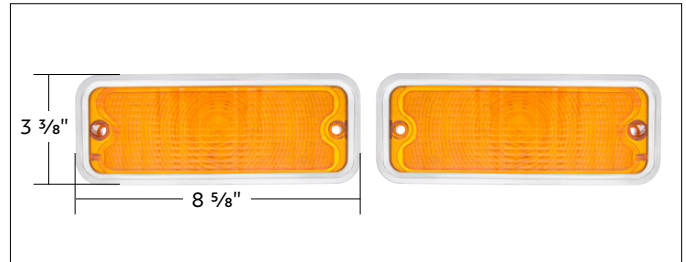

17 Amber LED Front Parking Lights With SS Trim - Clear Lens (Pair)

1973-1980 Chevy & GMC Truck

- Set includes L/H #110964 & R/H #110965 pair pre-packed in one box for shipping
- High quality injection molded polycarbonate lens
- Fully epoxy sealed electronics to resist corrosion and moisture
- Features 17 bright SMD type amber LEDs
- Beautiful stainless steel trim
- Dual function with parking light & bright turn signal
- Easy electrical connection w/ 1157 plug, no modification to vehicle
- Some applications may require the indexing tab to be removed
- LED compatible flasher required for proper operation, item #90652 or #90649
- DOT/SAE, FMVSS 108

111109 | Clear Lens

Pair / Wbox

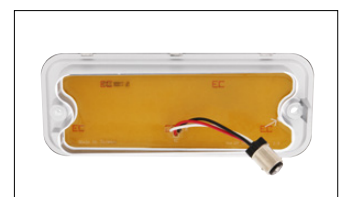
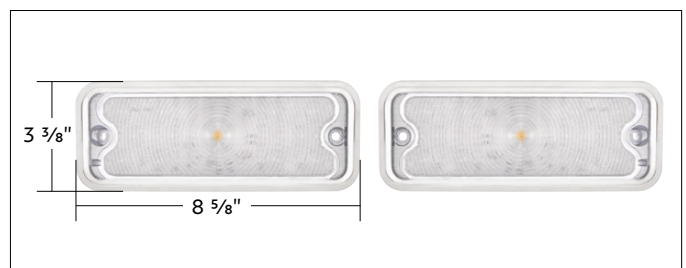

Exterior Mirror Bundle With LED Turn Signal (Pair)

1973-1987 Chevy & GMC Truck

- Bundle includes #C738710-LED & #C738710-CVXLED pair pre-packed in one box for shipping
- Exceptional quality die-cast & beautiful chrome plated D49 style mirror arm & housing
- Includes mounting pad, mounting bracket and screws
- Special behind-the-mirror LED design, hidden when not in use
- Features convex mirror for wide angle visibility (#C738710-CVXLED)
- LED turn signal arrow for safety & visibility when changing lanes
- Easy 12V hookup, just route wire through door jamb & connect to front turn signal wires under dash near steering column

111111 | Exterior Mirror Bundle W/ LED TS | Pair / Wbox

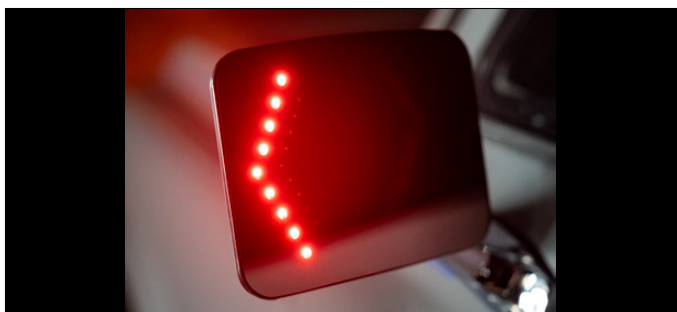
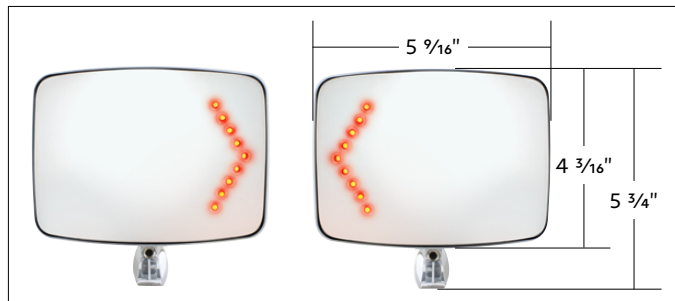

30 LED Backup Lights (Pair)

1967-1972 Chevy & GMC Truck

- Set includes L/H #110200 & R/H #110201 pair pre-packed in one box for shipping
- Quality polycarbonate lens with Bullseye lens pattern
- Super bright white LEDs w/ epoxy coated 12V DC electronics
- Easy plug-in design w/ 1156 plug, no modification to vehicle

111110 | 30 LED Backup Light Set | Pair / Wbox

CHROME
HIGH-QUALITY
CHROME FINISH

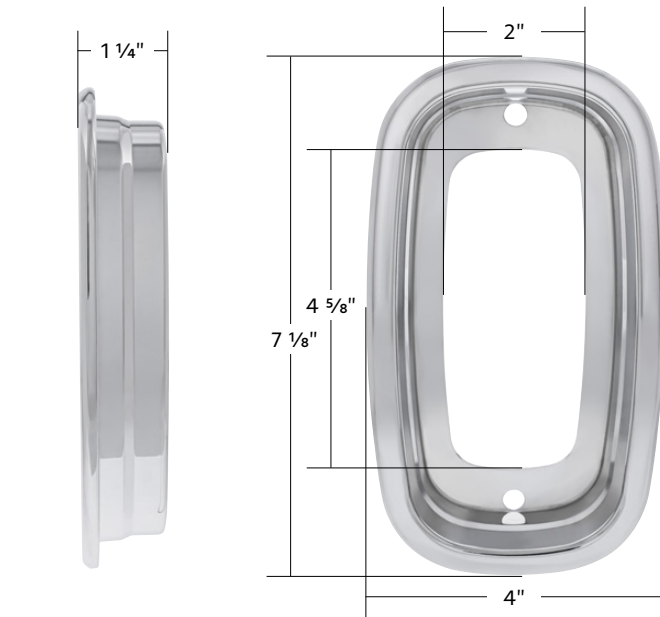

Chrome Die-Cast Tail Light Bezel

1960-1966 Chevy Fleetside Truck

- Quality die-cast with beautiful chrome plated finish
- Original style with mounting holes for easy installation

111090 | Chrome Die-Cast Tail Light Bezel | 1 Pc. / Wbox

30 LED Tail Lights (Pair)

1970-1973 Chevy Camaro

- Set includes L/H #CTL7073LED-L & R/H #CTL7073LED-R pair pre-packed in one box for shipping
- Super bright red LED with high quality injection molded polycarbonate lens
- Includes polished stainless steel lens trim attached
- Dual function with tail light & bright stop/turn signal
- Fully sealed electronic solid state circuit boards are designed to operate at 12V DC
- Easy electrical connection w/ 1157 plug, no modification to vehicle
- LED compatible flasher required for proper operation, item #90652 or #90649

111114 | 30 LED Tail Light Set

| Pair / Wbox



84 LED Sequential Tail Lights (Pair)

1969 Chevy Camaro

- Set includes L/H #110108 & R/H #110109 pair pre-packed in one box for shipping
- Super bright LED, complete with high quality injection molded polycarbonate lens
- Feature sequential function with selector switch to control sequential function off/on
- Also features brake attention option w/ sequence-once function
- Includes polished stainless steel trim ring attached
- Epoxy coated, fully sealed electronics
- Easy electrical connection w/ 1157 plug, no modification to vehicle
- Energy efficient solid-state circuit board engineered for 12V DC systems
- LED compatible flasher required for proper operation, item #90652 or #90649
- Lifetime warranty

111116 | 84 LED Sequential Tail Light Set

| Pair / Wbox

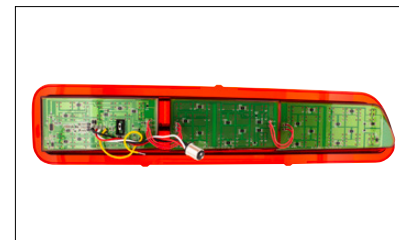
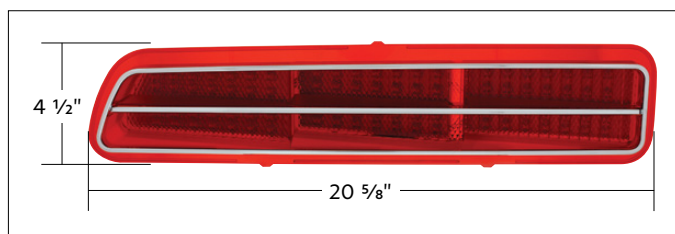

36 LED Tail Lights (Pair)

1970-1972 Chevy El Camino & Station Wagon

- Set includes L/H #CTL7072LED-L & R/H #CTL7072LED-R pair pre-packed in one box for shipping
- Super bright LED with high quality injection molded polycarbonate lens
- Dual function with tail light and bright stop/turn signal
- Epoxy coated, fully sealed electronics
- Easy electrical connection w/ 1157 plug, no modification to vehicle
- LED compatible flasher required for proper operation, item #90652 or #90649

111120 | 36 LED Tail Light Set

Pair / Wbox

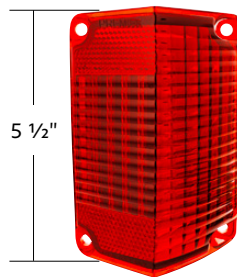
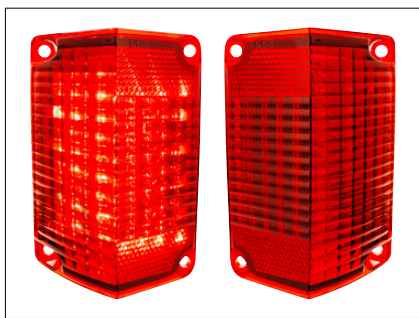
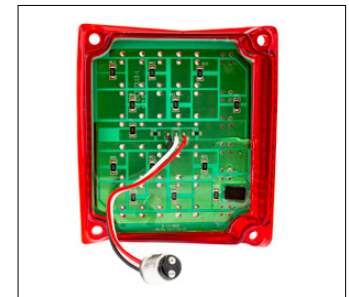
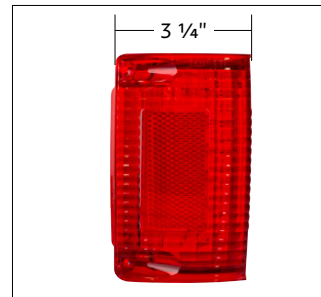
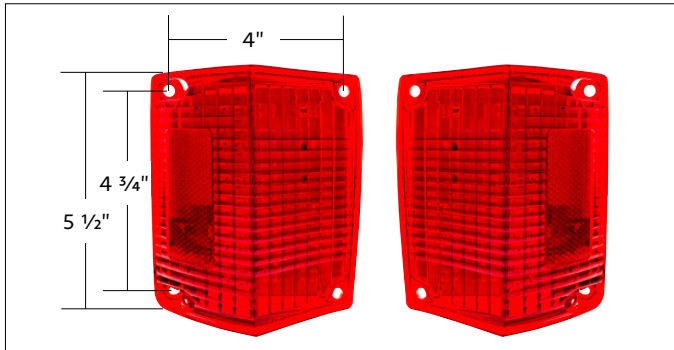

30 LED Tail Lights (Pair)

1968-1969 Chevy El Camino & Station Wagon

- Set includes L/H #CTL6869LED-L & R/H #CTL6869LED-R pair pre-packed in one box for shipping
- Super bright LED complete with red polycarbonate lens
- Dual function with tail light & bright stop/turn signal
- Epoxy coated, fully sealed electronic
- Easy electrical connection with 1157 plug, no modification to vehicle
- LED compatible flasher required for proper operation, item #90652 or #90649

111117 | 30 LED Tail Light Set

Pair / Wbox

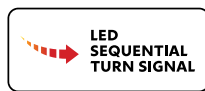

27 LED Tail Light With 6 LED License Plate Lights (Pair)

1937-1938 Chevy Passenger Car & 1940-1953 Truck

- Set includes L/H #CTL4053LED-L & #CTL4053LED-R pair pre-packed in one box for shipping
- Super bright LED with high quality injection molded polycarbonate lens
- Features sequential function with selector switch to control sequential function off/on
- Epoxy coated, fully sealed electronics
- Energy efficient solid-state circuit board engineered for 12V DC systems
- LED compatible flasher required for proper operation, item #90652 or #90649
- Features LED license illuminator lens with 6 super bright white LED (left-hand side)

111121 | 27 LED Tail Light

Pair / Wbox

42 LED Tail Lights With Stainless Steel Trim (Pair)

1972 Chevy Chevelle SS & Malibu

- Set includes L/H #CTL7201LED-L & R/H #CTL7201LED-R pair pre-packed in one box for shipping
- Super bright LED complete with polycarbonate lens and stainless steel trim
- Dual function with tail light and bright stop/turn signal
- Epoxy coated, fully sealed electronics
- Easy electrical connection w/ 1157 plug, no modification to vehicle
- LED compatible flasher required for proper operation, item #90652 or 90649
- Lifetime warranty

111119 | 42 LED Tail Light Set w/ SS Trim | Pair / Wbox

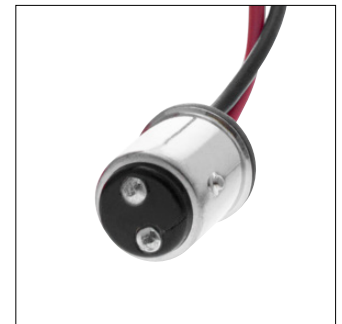
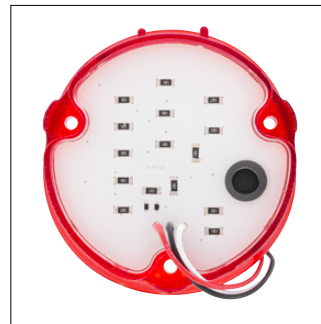
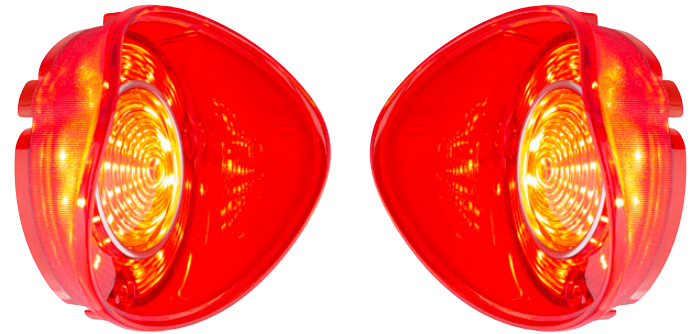

41 LED Tail Light Sets (Pair)

1965 Chevy Chevelle & Malibu

- Set includes L/H #CTL6521LED-L & R/H #CTL6521LED-R pair pre-packed in one box for shipping
- Super bright red LED with high quality injection molded polycarbonate lens
- Highly polished stainless steel trim
- Easy electrical connection w/ 1157 plug, no modification to vehicle
- Energy efficient solid-state circuit board engineered for 12V DC systems
- Epoxy coated, fully sealed electronics
- LED compatible flasher required for proper operation, item #90652 or #90649
- Lifetime warranty

111118 | 41 LED Tail Light Set | Pair / Wbox

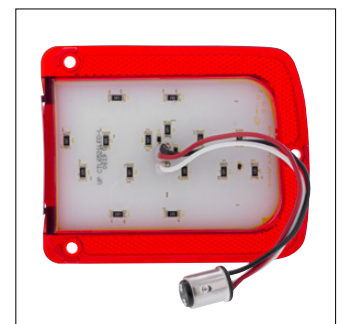
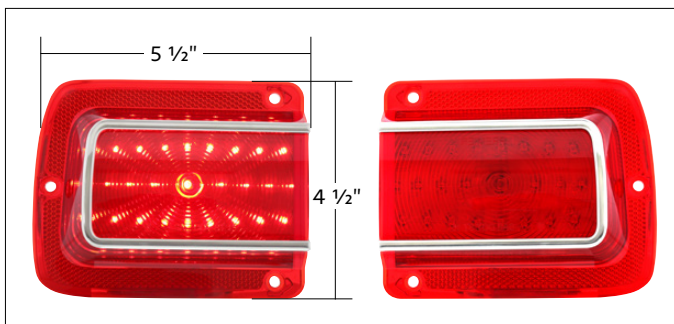

LED Sequential Tail Light Insert Boards (Pair)

1970 Chevy Chevelle

- Set includes L/H #110157 & R/H #110158 pair pre-packed in one box for shipping
- 48 super bright red LED tail light insert board
- Features sequential function with selector switch to control sequential function off/on
- Also features brake attention option w/ sequence-once function
- Epoxy coated, fully sealed electronics
- Easy electrical connection w/ 1157 plug, no modification to vehicle
- Energy efficient solid-state circuit board engineered for 12V DC systems
- LED compatible flasher required for proper operation, item #90652 or #90649

111122 | LED Sequential TL Insert Board Set | Pair / Wbox

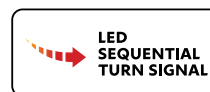
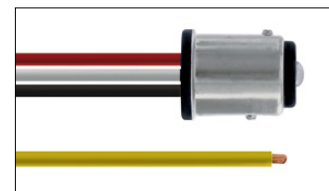
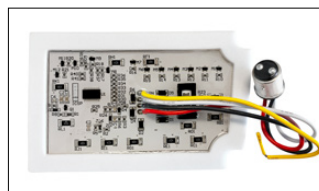
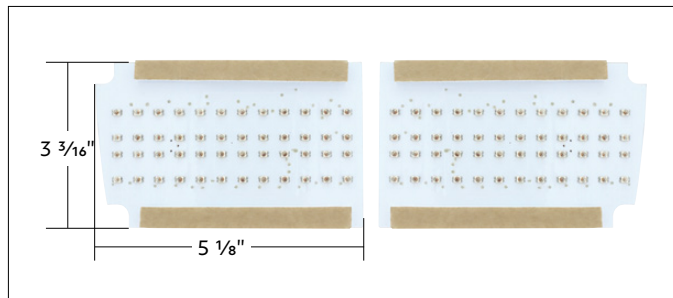
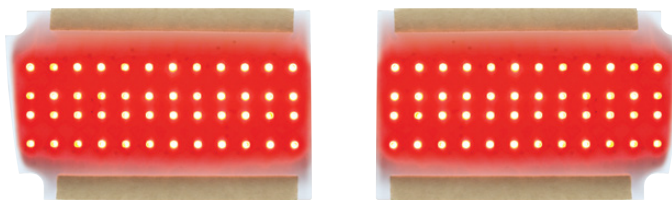

52 LED Tail Lights (Pair)

1968 Chevy Chevelle

- Set includes L/H #CTL6821LED-L & R/H #CTL6821LED-R pair pre-packed in one box for shipping
- Super bright red LED with high quality injection molded polycarbonate lens
- Epoxy coated, fully sealed electronics
- Easy electrical connection w/ 1157 plug, no modification to vehicle
- Energy efficient solid-state circuit board engineered for 12V DC systems
- LED compatible flasher required for proper operation, item #90652 or #90649

111115 | 52 LED Tail Light Set | Pair / Wbox

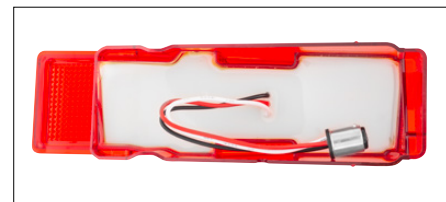
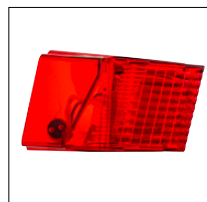
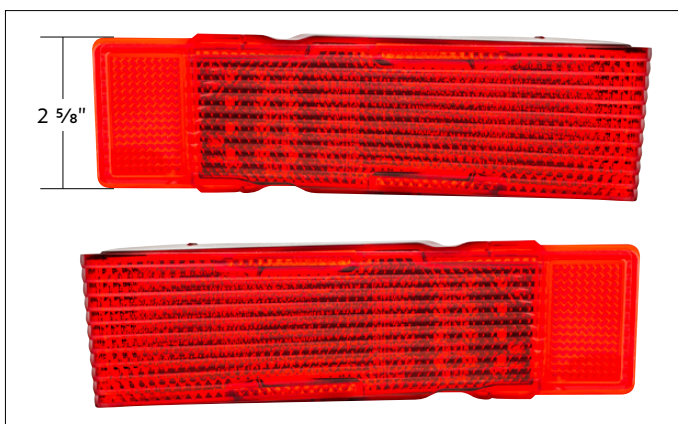

23 LED Tail Lights (Pair)

1964 Chevy Chevelle

- Set includes L/H #CTL6402LED-L & R/H #CTL6402LED-R pair pre-packed in one box for shipping
- Super bright red LED with high quality injection molded polycarbonate lens
- Dual function with tail light & bright stop/turn signal
- Epoxy coated, fully sealed electronics
- Easy electrical connection w/ 1157 plug, no modification to vehicle
- LED compatible flasher required for proper operation, item #90652 or #90649

111123 | 23 LED Tail Light Set

Pair / Wbox

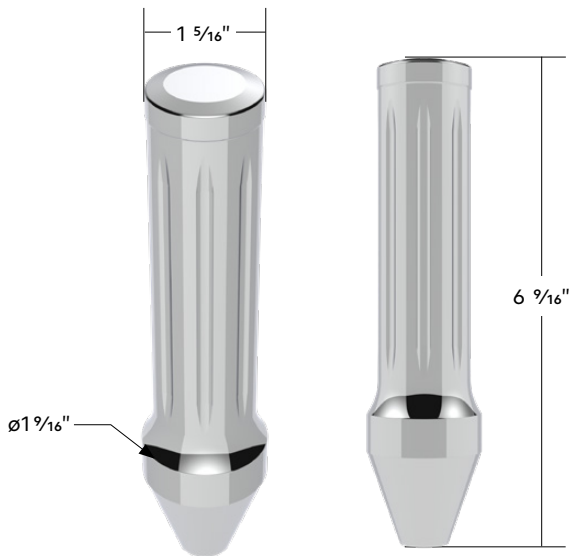
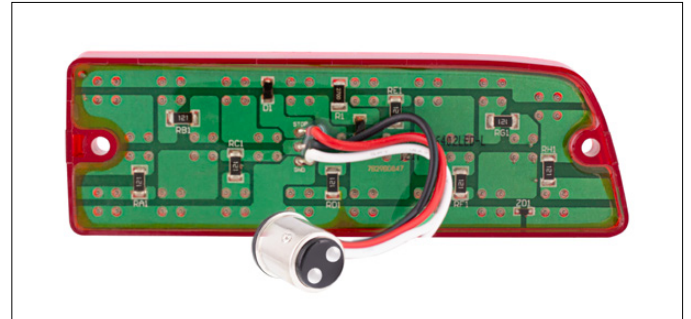
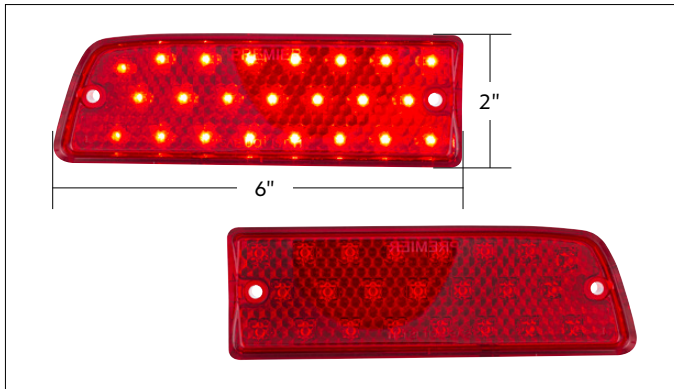

Dallas Style Grooved Grip Handle With Beer Tap Adapter - Chrome

Dallas Style Grooved Grip Handle

- Beautiful chrome plated finish w/ triple chrome plating process
- High quality CNC machined grip handle and adapter
- 3/8"-16 female thread for use w/ most beer faucet (faucet not included)

70895 | Chrome

1 Pc. / Card

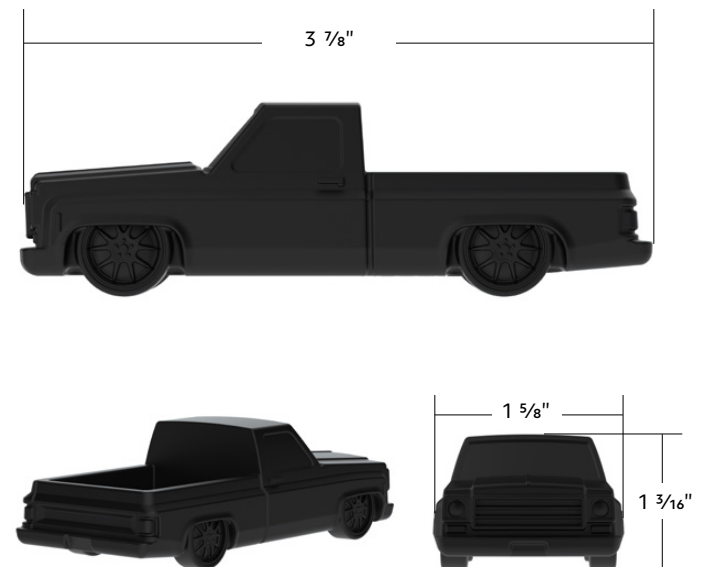

Matte Black Solid Die-Cast Paper Weight

1973-1987 Chevy Truck Style

- Solid zinc die-cast, modeled after a 1974 Chevy C10 truck
- Weighs roughly 3/4 lb, perfect for desk decor or paper weight

99222 | Matte Black Chevy Truck Paper Weight | 1 Pc./Wbox