



United Pacific

CLASSIC CAR & TRUCK

2020 New Product Collection





United Pacific

HOW TO ORDER

To order from United Pacific Industries, you must be an authorized dealer, distributor or OEM.
If you are not authorized to stock and sell United Pacific products, you must order through an authorized dealer.
Please call 866.327.5288 for more information.

CONTACT US



8 am - 4:30 pm PST



866.327.5288 / 562.425.5588



888.986.6088 / 562.425.3632



Antique@upauto.com



UPauto.com



3788 E. Conant St., Long Beach, CA 90808



QUALITY

With over 30 years of experience in the automotive aftermarket industry, United Pacific Industries understands the rigors and stresses that our products are subjected to on the road. It is our mission to provide our customers with products of superior quality and reliability. In achieving this goal, United Pacific only partners with manufacturing facilities that conforms to our quality control requirements and standards. Our manufacturing partners meet or exceed ISO-9001 requirements. In addition, United Pacific's manufacturing partners must be equipped on site to perform the following quality assurance tests and maintain a track record of consistent quality and low product failure rate.

- Aging Test
- Air Tight Test
- Dust Test
- Flux Test
- Photometric Test
- Pull Force Test
- Rain Test
- Salt Spray Test
- Shock Test
- Temperature Test
- Humidity Test
- Vibration Test

Furthermore, our internal quality control structure allows us to function as the final quality control station prior to shipping. With the assistance of 3D computer technology, United Pacific can adhere to strict quality control standards during prototype creation and the production process. Our engineers and technicians perform a battery of tests to ensure that our products meet the demands of today's drivers and our goal to be first in quality.

INNOVATION

Known as the leader in innovation, United Pacific is dedicated to be the first to bring new and exciting products to the market. United Pacific's global expertise allows us to search the globe for new ideas and concepts. Not only do we search the globe for new products, United Pacific invest a significant amount of resources into our own research and development efforts. With the assistance of advance 3D scanning technology, our engineers and designers can acquire accurate and precise data in seconds.

The 3D data allows United Pacific to verify designs, perform quality assurance tests, and reverse engineer with unprecedented speed and accuracy. Digital inspection contributes to the early detection of shape problems, provides rapid feedback on design, and eliminates unnecessary work in downstream processes. Our rapid prototyping facility permits us to have a concept-to-shelf time of less than 5 months. In addition, United Pacific's 3D printing capabilities permit our designers to have physical models of their design concepts in hours. The physical models allow our designers and marketing staff to evaluate and test the viability of different design ideas. Our rapid prototyping facility allow United Pacific to compress design cycles, improve manufacturing planning, shorten concept-to-shelf time, most importantly, generate new and innovative products.

DESIGN

Located near some of the nation's most progressive automotive design centers, United Pacific established the UP Design Studio in 2002 to consolidate our position as the design leader in the automotive industry. UP Design Studio utilizes the latest generation of computer aided design (CAD) and studio/graphic software. The design studio is equipped with the newest computers and rapid prototyping systems. In addition, UP Design Studio is staffed by graduates from the nation's most prestigious design colleges. Unlike our competitors, United Pacific's design and manufacturing capabilities mean that we carry more new and original items than our competitors. The establishment of the design studio will enable us to generate even more new products with significant shorter concept-to-shelf time. The reduction in development cost mean that we can develop products utilizing design based development processes. Design based product development allows United Pacific to create new product concepts based on designs incorporating driver demands and needs instead of economic considerations. United Pacific's emphasis on design distinguishes and positions us ahead of our competitors.



WARRANTY

With LED (Light Emitting Diodes) rated at 100,000 hours of operation and solid-state construction, United Pacific's LED lights are extremely reliable and durable. Purchase with confidence, United Pacific offers a complete line of LED lighting products with extended or limited lifetime warranties. Please see the warranty policy page for more details.

INVENTORY AND SHIPPING

United Pacific carries over 20,000 items in our California distribution center. No other company in the heavy duty trucking industry can match United Pacific in the variety and range of in-stock inventories. With an order fill rate of over 98.5%, United Pacific is the largest and most reliable supplier in the industry. Our shipping department ships 96.8% of all orders within 24 hours and 98.9% within 48 hours. United Pacific's vast inventory and prompt shipping has made United Pacific the only source for our customer's chrome and lighting needs.



HARD AT WORK FOR THE ENVIRONMENT



United Pacific
132,000 sq ft

Distribution Center
Long Beach, CA

100% reduction in potable water used for landscaping

40% reduction in total energy use due to high-efficiency mechanical and lighting systems

82% of construction waste was diverted from landfills

LEED ACCOMPLISHMENTS

Sustainable Sites

- On-site bicycle storage, showers and changing areas for company employees.
- Preferred parking for low-emitting, fuel-efficient and carpool vehicles.
- Storm water is infiltrated on-site and treated to remove contaminants to reduce environmental impact on local waterways.

Water Efficiency

- In addition to using reclaimed water, drought-tolerant plants and a high-efficiency irrigation system were installed to reduce the use of potable water for irrigation by 100%.

Energy and Atmosphere

- Efficient HVAC equipment and a lighting system with daylight controls reduces energy consumption by over 30%.
- Enhanced commission verifies that the building's energy and water-related systems are performing as intended by the initial design.

Indoor Environmental Quality

- Building ventilation systems was designed to provide enhanced levels of fresh outside air to building occupants.
- Interior finishes (plants, sealants, adhesives, coatings, carpet systems and composite wood) were selected with low levels of volatile organic compounds (VOCs) to reduce indoor air contamination.



NEW ITEMS

January 2020



Chrome Exterior Mirror For 1966-77 Ford Bronco & 1967-79 Truck

- Exceptional quality die cast metal and beautifully chrome plated
- Available with special behind-the-mirror LED design, hidden when not in use
- Convex mirror for wide angle visibility for R/H side
- Includes mounting pad and screws

110735 Fits L/H or R/H - 1 Pc. / Color Box

110736 L/H w/LED Turn Signal - 1 Pc. / Color Box

110737 R/H w/Convex Mirror - 1 Pc. / Color Box

110738 R/H w/Convex Mirror &LED Turn Signal - 1 Pc. / Color Box



Chrome Plated Grille Without Lettering For 1969-77 Ford Bronco

- Die stamped with high quality 17 gauge sheet metal
- Features original contour, detail and mounting brackets for the larger turn signal lights
- Smooth center bar design without FORD letters to keep that clean front end look
- Beautiful show ready chrome plated finish
- Headlight adjusters also included for easy headlight installation and adjustment

110516 1 Pc. / Box





Aluminum Grille Shell Without Insert For 1971-72 Chevrolet Truck

- Stamped aluminum with highly polished and anodized finish
- Features all the original contour and headlight mounting holes
- Fits 1971-72 Chevy Truck, Blazer, and Suburban
- Inner grille insert available separately, UP# 110869

110868 1 Pc. / Box

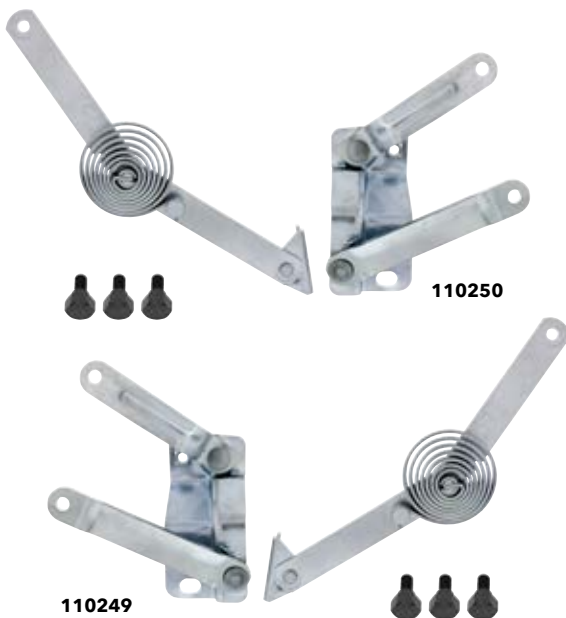

Hood Hinge & Support For 1947-55 Chevy & GMC Truck 1st Series

- Heavy duty steel reproduction of the original hood hinge style and design
- Fits 1947-55 Chevy & GMC 1st series truck
- Includes hood support arm with clock spring
- Zinc plated finish for better corrosion resistance
- Includes (3) OE style shoulder bolts for proper installation

110249 L/H - 1 Set / Box

110250 R/H - 1 Set / Box



Hood Hinge For 1967-72 Chevrolet & GMC Truck

- Heavy duty steel reproduction of the original hood hinge style and design
- Finish with black EDP protective coating to keep your new steel fresh and rust-free
- Springs available separately, UP#110879

110877 L/H - 1 Pc. / Bulk

110878 R/H - 1 Pc. / Bulk



Cab Mount Kit For 1955-59 Chevy Truck

- Quality molded rubber cab mounts
- Includes all mounting bolts, lock nuts, spacers and large washers
- 22 piece kit
- Includes installation diagram

110842 1 Set / Box

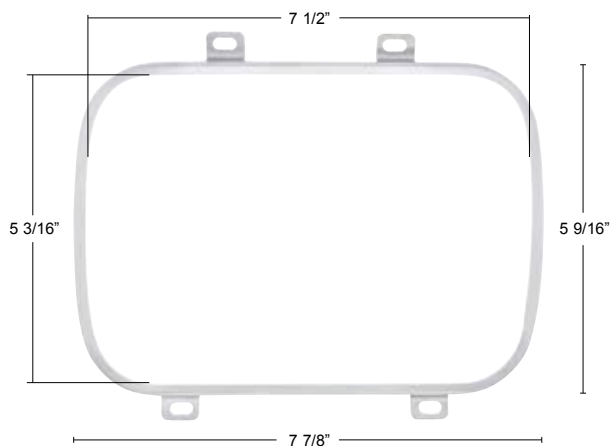

Stainless Steel 5" X 7" Headlight Retaining Ring

- 304 Stainless steel with 4 screw tabs
- Check measurements for your application
- Sold each

30610B 1 Pc. / Bulk



36454



36455



36456



36457

4.5" 24 High Power LED Work Light With "X" Light Guide

- High power SPOT & FLOOD beam combination work light with unique 15 LED "X" light guide design
- Water resistant die cast housing, polycarbonate lens provides maximum protection & durability
- Solid state design resists shock and vibration
- 5200 lumens, IP 67 water resistant
- 12VDC - 24VDC

36454 Amber - 1 Pc. / Color Box

36455 Blue - 1 Pc. / Color Box

36456 Red - 1 Pc. / Color Box

36457 White - 1 Pc. / Color Box

⊗ Light Guide High Power LED Front Spot Light



High Power LED Front Flood Light



NEW ITEMS

February 2020



Round Exterior Mirror For 1966-72 Chevy Passenger Car

- Exceptional quality die cast metal and beautifully chrome plated with Chevy bowtie logo
- Available with special behind-the-mirror LED design, hidden when not in use
- Convex mirror for wide angle visibility for R/H side
- Includes mounting pad and screws
- Officially licensed GM restoration part

C687201 Fits L/H or R/H - 1 Pc. / Color Box

110826 R/H w/Convex Mirror &LED Turn Signal - 1 Pc. / Color Box

110827 R/H w/Convex Mirror - 1 Pc. / Color Box

110825 L/H w/LED Turn Signal - 1 Pc. / Color Box



One-Piece Style LED Tail Light For 1955 Chevy Car

- 48 SMD super bright LED with high quality all red polycarbonate lens
- Custom style one-piece design with backup light deleted
- Direct plug & play installation with 1157 type connector
- Electronics completely sealed in epoxy to resist corrosion and moisture
- Solid state circuit board engineered for any 12VDC system

110206 1 Pc. / Card



LED Side Marker For 1970-77 Ford Bronco

- 8 LED Dual function, parking light and turn signal
- Super bright amber LED with amber or red acrylic lens
- Epoxy coated, fully sealed electronics
- Fits left hand and right hand

110804 Front LED Side Marker - Amber - 1 Pc. / Card

110805 Rear LED Side Marker - Red - 1 Pc. / Card



289/302/351W Long Tube Headers For 1966-77 Bronco

- Fits all 1966-77 Broncos with a 289, 302, or 351W V8 engine
- Extra-thick 16 gauge 1 1/2" mandrel-bent tube
- 3/8" thick laser cut flanges resist warping
- Designed to provide ample clearance for tight areas
- Long tube design delivers maximum horsepower and torque

110588 Black - 1 Set / Box

110589 Silver Ceramic Coated - 1 Set / Box



Plain Style Tailgate Without Ford Letters For 1966-77 Ford Bronco

- High quality heavy 16 gauge steel aftermarket reproduction of the original Ford tailgate
- Precision cut latch handle pocket with 1/4"-20 welded nuts and recessed mounting holes on the inside panel
- Includes tailgate linkage posts, tailgate trunion pockets, and latch pockets with 5/16"-18 threaded holes
- Features license plate light pocket, wiring holes, and small 0.087" diameter mounting holes
- Finished with black EDP protective coating to keep your new steel fresh and rust-free

110884 1 Pc. / Box



Chrome Interior Dome Light Assembly For 1960-72 Chevy/GMC Truck & Suburban

- Chrome plastic housing with lens, 12V light bulb, 143" OE style wiring harness and plug connector

110876 1 Pc. / Box



Rear Inner Wheelhouse For 1967-72 Chevrolet Fleetside Truck

- Excellent 18 gauge steel reproduction of the OE style wheelhouse
- Features all original curvature and mounting pattern
- Finished with black EDP protective coating to keep your new steel fresh and rust-free
- Fits lefthand or righthand side, two required for each truck
- Fits 1967-72 Chevrolet/GMC Fleetside Truck, 67-72 Chevrolet Blazer and 70-72 GMC Jimmy

110867 1 Pc. / Bulk



Sitting Pig Ornament

- Detailed die-casting with beautiful chrome plating
- Easy installation on any vehicle with three mounting studs
- Approximately 5-1/2" x 3-1/2" x 4-1/2"
- Mounting pad and hardware included
- Perfect decorator item for home, office and man cave

72046 Chrome - 1 Pc. / Color Box

72047 Black - 1 Pc. / Color Box



Cab Mount Kit For 1960-66 Chevy Truck

- Quality molded rubber cab mounts
- Includes all mounting bolts, lock nuts, spacers and large washers
- 28 piece kit

110860 1 Set / Box



110863



110864

Stainless Steel Flag Holder with Flags

- Stainless flag holder with flags
- Show your patriotism

110863 3 Flags - 1 Set / Card

110864 5 Flags - 1 Set / Card



110861

110862

Stainless Steel Flag Holder

- Stainless flag holder only
- Fits United Pacific U.S.A. flag item No. C9003

110861 3 Post - 1 Pc. / Bulk

110862 5 Post - 1 Pc. / Bulk

NEW ITEMS

March 2020



One-Piece Style Sequential LED Tail Light For 1955 Chevy Car

- 48 SMD super bright LED with high quality all red polycarbonate lens
- Custom style one-piece design with backup light deleted
- Features sequential function with selector switch to control sequential function off, direction left, or direction right
- Also features brake attention option with sequence-once function
- Direct plug & play installation with 1157 type connector
- Electronics completely sealed in epoxy to resist corrosion and moisture
- Solid state circuit board engineered for any 12VDC system
- Recommend to upgrade under dash flasher to item no. 90652 or 90649 LED flasher
- Recommend license plate with LED back-up light, item no. 50187



(((BRAKE ATTENTION)))

(((SEQUENTIAL)))
F · L · A · S · H



110207

1 Pc. / Card



Chrome 1929-39 California License Plate Frame

- For Vintage 1929-39 California license plates w/ sharper corners
- High quality stamped steel with chrome plating

50088 1 Pc. / Card



Chrome 1940-55 California License Plate Frame

- For Vintage 1940-55 California license plates w/ rounded corners
- High quality stamped steel with chrome plating

50089 1 Pc. / Card



Rear Fuel Tank Strap For 1966-76 Ford Bronco

- Made of high-quality galvanized stamped steel
- Black EDP coated to keep your new steel fresh and rust-free
- J-bolt included for proper installation

110806 1 Pc. / Bulk

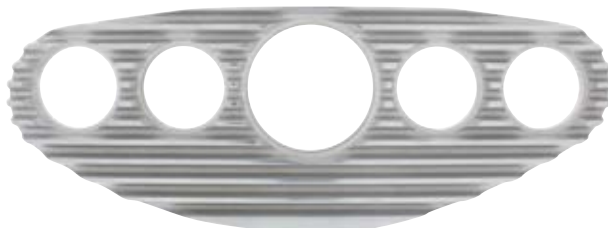

110480

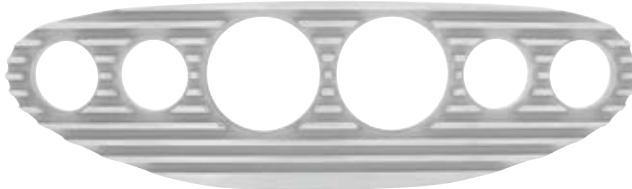

110481



Finned Style Aluminum Dash Panel

- Cast with aluminum and CNC finished faces
- Finned style design
- Four outer holes with 2-1/16" inside diameter
- Two pre-tapped #6-32 holes for straight forward installation

110480 Five Hole - 1 Pc. / Box

110481 Six Hole - 1 Pc. / Box



Chrome "Bel-Air" Script Emblem For 1955-56 Chevy Bel-Air

- Fits rear quarter panel, duplicate of original
- Beautiful chrome plated with triple chrome plating process
- Includes mounting clips
- GM restoration licensed product

C555601 1 Pc. / Bulk



COMPETITION
SERIES

2 White LED Chrome License Plate Light/Utility Light - Competition Series

- Super bright white LED utility/license light, 12 volt
- Chrome housing, water resistant
- Includes mounting pad & screws

39909 1 Pc. / Card



99193



99194



99195

United Pacific Work Light Display

- Polished stainless steel display base
- Completely assembled and wired
- 12 Volt power supply included

99193 36671/36672/36507/36965 - 1 Pc. / Box

99194 36461/36462/36506/36965 - 1 Pc. / Box

99195 36463/36464/36506/36965 - 1 Pc. / Box

NEW ITEMS

April 2020



Super bright white LED cargo bed floor illumination



Integrated LED 3rd Brake Light



LED Cargo Light Assembly For 1969-72 Chevy & GMC Truck

- Super bright LED cargo light assembly with integrated LED 3rd brake light
- High quality heavy chrome plated die-cast housing
- Includes large rubber mounting pad, socket, lens gasket, lens screws and housing to cab mounting spacers

110147 1 Pc. / Color Box



Incandescent Cargo Light Assembly For 1969-72 Chevy & GMC Truck

- Complete original style incandescent cargo light assembly with 1004 bulb
- High quality heavy chrome plated die-cast housing
- Includes large rubber mounting pad, socket, lens gasket, lens screws and housing to cab mounting spacers

110446 1 Pc. / Color Box



110149



110217



110168



39065



110148

110149 Mounting Pad - 1 Pc. / Bulk

110217 Lens Gasket - 1 Pc. / Bulk

110168 Lens - 1 Pc. / Card

39065 1004 Type Bulb - 1 Pc. / Bulk

110148 1004 Chrome Housing with Gasket - 1 Pc. / Color Box





LED Sequential Turn Signal



24 High Power LED 7" Light With Dual Color Position Light

- 24 LED high power 7" light with 8 dual color LED position light
- LED white/amber position light bar changes from white to amber when sequential light is activated
- Sequential amber position light can be connected for lefthand or righthand operation
- High beam: 5000 Lumens; Low beam: 2000 lumens; Position light-white: 200 lumens; Position light-amber: 125 lumens
- Easy connection, plugs into existing wiring harness, position light requires additional wiring. Installation in some OE light housings may require modification
- For off-road use only

Technical Specification

Low Beam Application	High Beam Application
2000 Lumens	5000 Lumens
6000-6500K	6000-6500K
12VDC - 24VDC input	12VDC - 24VDC input





36452 1 Pc. / Color Box



Antique New Item Flyer Collection

- ANF1219** 2019 New IItem Flyer Collection - 48 pages, high gloss, 4 color, perfect bound catalog - 1 Pc. / Bulk
- ANF1218** 2018 New IItem Flyer Collection - 82 pages, high gloss, 4 color, perfect bound catalog - 1 Pc. / Bulk
- ANF1217** 2017 New IItem Flyer Collection - 62 pages, high gloss, 4 color, perfect bound catalog - 1 Pc. / Bulk
- ANF1216** 2016 New IItem Flyer Collection - 64 pages, high gloss, 4 color, perfect bound catalog - 1 Pc. / Bulk
- ANF1215** 2015 New IItem Flyer Collection - 174 pages, high gloss, 4 color, perfect bound catalog - 1 Pc. / Bulk

NEW ITEMS

May 2020



110837



110838

Anodized Billet Aluminum Turn Signal Bezel Set For 1969-77 Ford Bronco

- Beautifully CNC milled from billet aluminum
- Durable anodized finish to increase corrosion resistance while keeping the machined finished look
- Mounts between the front turn signal bucket and the grille
- Includes mounting gaskets
- Sold in pairs



Aluminum Bezel, Gasket Included

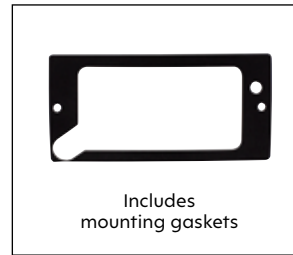

Includes mounting gaskets



110837 Clear Anodized Finish - 1 Set / Color Box

110838 Black Anodized Finish - 1 Set / Color Box



Bed Front Panel For 1967-72 Chevrolet & GMC Fleetside Truck With Steel Bed Floor

- Quality die stamped steel reproduction with 16 gauge steel
- Plain smooth style panel design
- OE style rolled over top flange with 1/4"-20 welded square nuts
- Precision punched bed side panel mounting holes
- Bottom flange made to match OE specification for use with steel bed floor

110896 1 Pc. / Box



23497



23498



23499

Chrome Thread-on Shift Knob

- High quality die-cast aluminum with triple chrome plating
- Inside thread 1/2"-13
- Made for vehicles with 1/2-13 threaded shifters. Great custom item for Rat Rods, Broncos & C10's. Adapters not included
- May also work for other vehicles with 1/2"-13 thread

23497 Skull - 1 Pc. / Card

23498 Ace of Spades - 1 Pc. / Card

23499 Eagle - 1 Pc. / Card



NEW & IMPROVED

NEW & IMPROVED

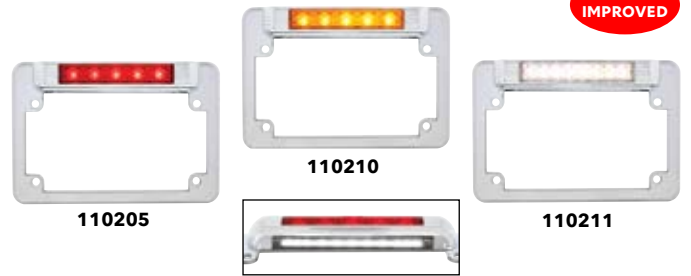

Chrome License Plate Light

- New and improved with SMD LED's for more lumen output, better heat dissipation, longer life
- Beautiful chrome die cast metal light housing with 5 LED light, and 11 LED license plate light
- Mounts to any surface with 2 mounting studs on back, 5-1/2" center-to-center
- Includes mounting pad with lip and mounting hardware.

- 110203** Red LED - 1 Pc. / Card
- 110204** White LED - 1 Pc. / Card
- 110265** Amber LED - 1 Pc. / Card

Chrome Motorcycle License Plate Frame w/ LED Light

- New and improved with SMD LED's for more lumen output, better heat dissipation, longer life
- Beautiful chrome die cast metal light housing with 5 LED light, and 11 LED license plate light
- Fits standard U.S. motorcycle license plates

- 110205** Red LED - 1 Pc. / Card
- 110210** Amber LED - 1 Pc. / Card
- 110211** White LED - 1 Pc. / Card

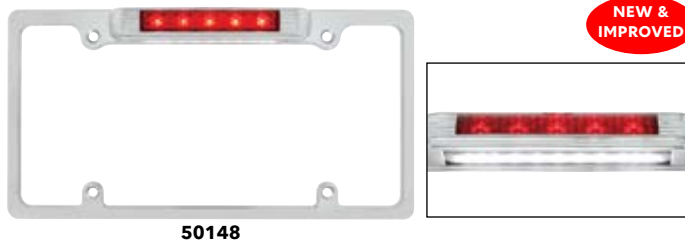

NEW & IMPROVED

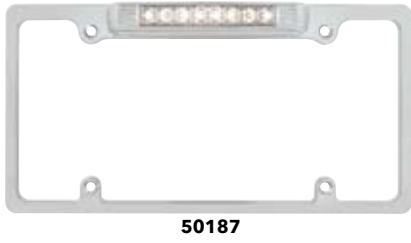

Chrome License Plate Frame w/ Auxiliary Light

- New and improved with SMD LED's for more lumen output, better heat dissipation, longer life
- Beautiful chrome die cast metal light housing with 5 LED light, and 11 LED license plate light
- Fits standard U.S. & Canadian 6" X 12" license plates
- Overall frame dimension 12-5/16" X 6-3/8"

- 50148** Red LED - 1 Pc. / Card
- 50149** Amber LED - 1 Pc. / Card
- 50187** White LED - 1 Pc. / Card

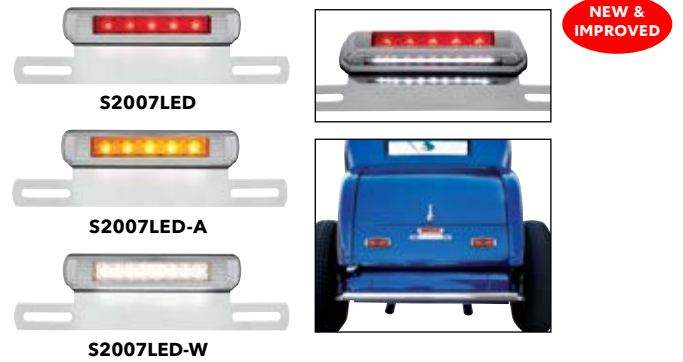

NEW & IMPROVED

Chrome Motorcycle License Plate Frame w/ LED Light

- New and improved with SMD LED's for more lumen output, better heat dissipation, longer life
- Beautiful chrome die cast metal light housing with 5 LED light, and 11 LED license plate light
- Mounts to any surface with 2 mounting studs on back, 5-1/2" center-to-center

- S2007LED** Red LED - 1 Pc. / Card
- S2007LED-A** Amber LED - 1 Pc. / Card
- S2007LED-W** White LED - 1 Pc. / Card



United Pacific Light Display - 7", 5-3/4", 4"x6", 5"x7"

- Quality point-of-purchase display made of steel and gloss black powder coated
- Includes United Pacific items: 31084, 31267, 34125, 31087
- Includes 12V power supply unit & wall plug
- Completely assembled and wired
- Display approximate size: 33-3/4" L X 12-3/4" W X 4 -1/2" H

- 99196** 1 Pc. / Box

NEW ITEMS

June 2020



110772



110773



Anodized Billet Aluminum Side Marker Bezel w/ Raised Side Protection For 1970-77 Ford Bronco

- Beautifully CNC milled from billet aluminum
- Durable clear anodized finish to increase corrosion resistance while keeping the machined finished look
- Includes two stainless steel screws and mounting gasket
- Also fits 1970-74 Econoline, and rear only on 1970-72 F100, F150, & F250
- Sold each

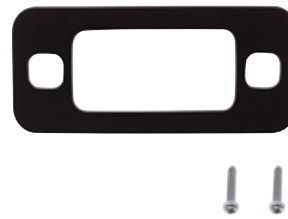

110772 Clear Anodized Finish - 1 Pc. / Color Box

110773 Black Anodized Finish - 1 Pc. / Color Box



110774



110775



Anodized Billet Aluminum Side Marker Light Bezel For 1970-77 Ford Bronco

- Beautifully CNC milled from billet aluminum
- Durable clear anodized finish to increase corrosion resistance while keeping the machined finished look
- Includes two stainless steel screws and mounting gasket
- Also fits 1970-74 Econoline, and rear only on 1970-72 F100, F150, & F250
- Sold each

110774 Clear Anodized Finish - 1 Pc. / Color Box

110775 Black Anodized Finish - 1 Pc. / Color Box

HOT ITEM

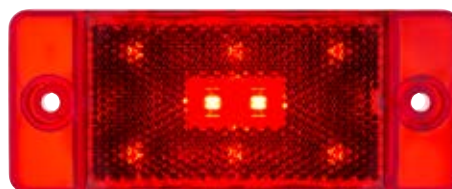
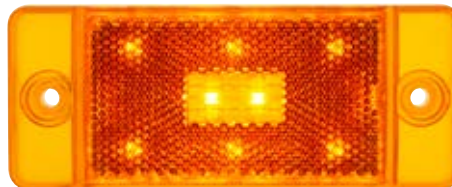

LED Side Marker For 1970-77 Ford Bronco

- 8 LED Dual function, parking light and turn signal
- Super bright amber LED with amber or red acrylic lens
- Epoxy coated, fully sealed electronics
- Fits left hand and right hand

110804 Front LED Side Marker - Amber - 1 Pc. / Card

110805 Rear LED Side Marker - Red - 1 Pc. / Card



110776



110777



Anodized Billet Aluminum Steering Column Cover For 1966-77 Ford Bronco

- Beautifully CNC milled from billet aluminum
- Upgrades the original plastic steering column cover to heavy duty billet aluminum
- Durable clear anodized finish to increase corrosion resistance while keeping the machined finished look
- Two-piece design for easy installation

- 110776** Clear Anodized Finish - 1 Pc. / Card
- 110777** Black Anodized Finish - 1 Pc. / Card

New Upgraded Slim Low Profile Design



36446

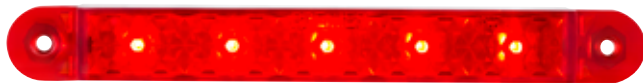

36447

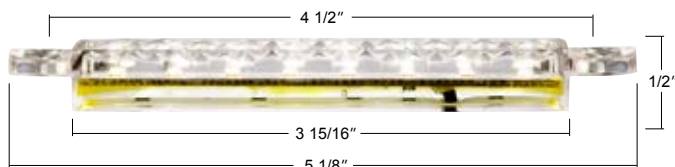

36448

5" SMD LED Light Strip With Hard Wire

- 5 Super bright SMD LED strip with fully sealed electronics
- 12VDC, available in dual function red or amber, or single function white
- Captive #6-32 nuts for rear flush mounted installation
- For clean and proper mounting, a 3-15/16 X 5/8" rectangular pocket is required
- See "Attachment-Line Art" for more dimensional details

- 36446** Amber LED - 1 Pc. / Card
- 36447** Red LED - 1 Pc. / Card
- 36448** White LED - 1 Pc. / Card



Tire Checker Bat

- United pacific 17" aluminum tire checker
- 99060** 1 Pc. / Bulk

NEW ITEMS

July 2020



110871



110870



Anodized Aluminum Headlight Bezel For 1969-72

- Quality stamped 24 gauge aluminum with rolled edges
- Beautiful clear anodized finish

110870 L/H - 1 Pc. / Box

110871 R/H - 1 Pc. / Box



Stainless Steel Hood Spring For 1967-72 Chevrolet & GMC Truck (Pair)

- Specially engineered to have the same yield and tensile strength as original
- Corrosion resistant stainless steel, with a bright electropolished satin finish
- Sold in pairs

110899 1 Pair / Bulk



GM Restoration Parts

Glove Box Lock Cylinder w/Keys For 1947-53 Chevy/GMC Truck

- Quality reproduction of original style lock cylinder
- Includes 2 keys with GM marking
- Official GM licensed restoration product

110888 1 Pc. / Bulk



GM Restoration Parts

Door Lock Cylinder W/Keys For 1947-51 Chevy/GMC Truck

- Outside door lock cylinder with 2 keys
- Official GM licensed restoration product

110887 1 Pc. / Bulk



Stellar Pluto+ Duo Bundle Headset

- A Trucker's "best friend" headset offering battery life for longest talk time, best comfort, unique style and quality sound
- "Pluto" mode is single earpiece and 30 hours of talk time / 500 hours of stand-by time
- "Duo" mode adds a stereo earpiece for 60 hours of talk time / 900 hours stand-by time
- "Duo" earpiece is also a USB power bank to charge other devices on the go
- Noise Armor® technology offers the best noise cancellation for truckers. No more "I can't hear"
- Bluetooth 5.0 compatible, and has longer range and more connectivity for your devices
- Durable carrying case, dual USB car charger, and USB cable included

95002 1 Set / Box

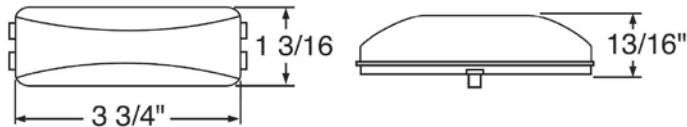

Incandescent Rectangular Fender Mount Clearance /Marker Light - Amber & Red Lens

- Functions as both front and rear clearance light for trailers over 80 inches wide
- High quality injection molded dual color, amber and red plastic lens
- Polycarbonate lens sonically sealed to housing to prevent moisture intrusion
- Grease filled terminals to prevent corrosion
- Recommend mounting/quick-connect base: item # 30919 (chrome) or item # 33006 (black)

31050 1 Pc. / Bulk

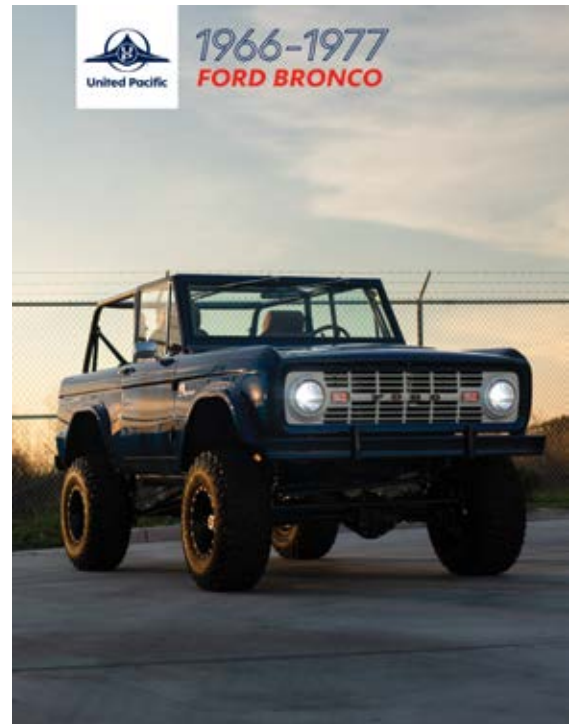

1966-77 Ford Bronco Catalog - 2nd Edition

- 54 pages, high gloss 4 color printing with UV coated cover
- 2nd Edition

ACBR02 1 Pc. / Bulk

NEW ITEMS

August 2020



34131



34132



34133



34134

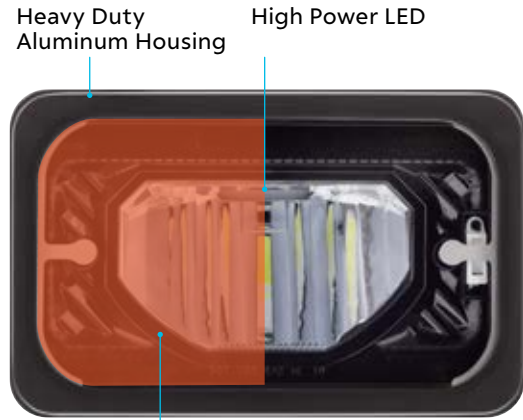

Heavy Duty Aluminum Housing

High Power LED

Electrical Heating System
Automatic De-ices the Headlight According to Ambient Temperature



100% LED

DOT

4" X 6" Heated LED Headlight

- Features a heating system that automatically de-ices the headlight according to ambient temperature
- Durable glass lens with heavy duty aluminum housing
- Plug & play with standard H4 style connector plug for ease of installation
- Available in high beam and low beam with choice of chrome or black inner liner
- Low beam: 1000 lumens, high beam: 1200 lumens, 12-24VDC, 20 watts

34131	Chrome	Low Beam - 1 Pc. / Color Box
34132	Chrome	High Beam - 1 Pc. / Color Box
34133	Black	Low Beam - 1 Pc. / Color Box
34134	Black	High Beam - 1 Pc. / Color Box

Technical Specification

Low Beam Application
1000 Lumens
12VDC - 24VDC Input
20 Watts

High Beam Application
1200 Lumens
12VDC - 24VDC Input
24 Watts



Dash Bezel For 1969-72 Chevy/GMC Truck With 7 Gauges - Black & Chrome

- High quality plastic injection molded reproduction of the original
- Beautiful chrome plated outer trim with black painted inner face
- Feature original mounting pattern with mounting posts for easy installation

110697 1 Pc. / Box



110897

110898



UP# 110899 Available Separately

Chrome Hood Hinge For 1967-72 Chevrolet & GMC Truck

- Heavy duty steel reproduction of the original hood hinge style and design
- Beautifully chrome plated with triple chrome plating process
- Stainless steel springs available separately, UP#110899

110897 L/H - 1 Pc. / Box

110898 R/H - 1 Pc. / Box



Bed Front Panel For 1932-37 Ford Truck

- Die stamped with high quality 16 gauge sheet metal
- Features original style stiffening ribs and square-shape top edge
- Finished with black EDP protective coating to keep your new steel fresh and rust-free

B21507 1 Pc. / Box



Black Arm Rest For 1968-77 Ford Bronco (Pair)

- Perfect for replacing that wore out arm rest on an early Bronco
- High quality synthetic leather in black finish
- Mounting pocket w/ original mounting pattern for easy replacement

110840 1 Pair / Box



Primer Finished Outside Sunvisor For 1955-59 Chevy Passenger Car

- Excellent reproduction with original detail
- Features precision punched mounting holes and center reinforcement brace
- Ready for paint with primer finished coating

C7016 1 Pc. / Bulk



Remote Exterior Mirror Kit For 1964.5 -66 Ford Mustang

- Beautiful die-cast and chrome plated exactly as original
- Features remote linkage with handle and mounting plate
- Includes mounting pad and screws

F646605 L/H - 1 Pc. / Box

F646606 R/H - 1 Pc. / Box



United Pacific Cap - Camo U.P. Cap

- 100% cotton twill cap

99086 1 Pc. / Bulk

NEW ITEMS

September 2020

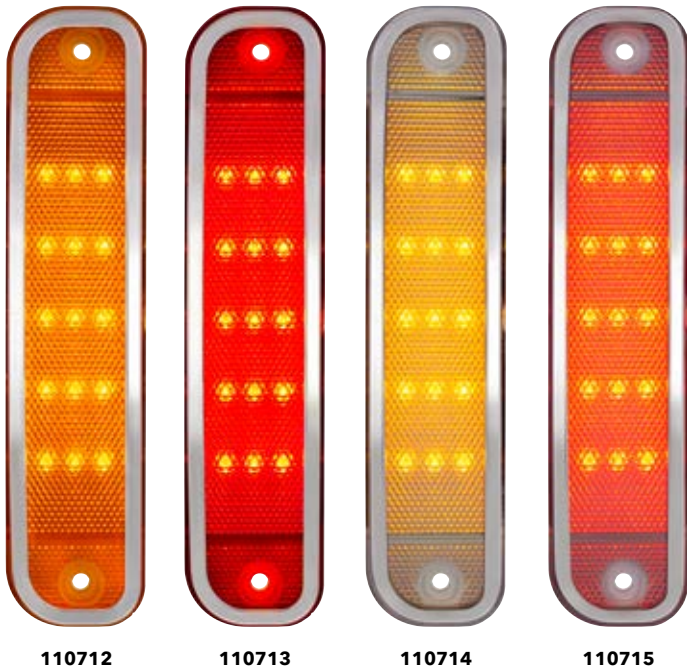

15 LED Side Marker Light With Stainless Steel Trim For 1973-80 Chevrolet Truck

- Super bright LED with high quality injection molded acrylic lens
- Dual function, parking light and turn signal
- Polished stainless steel deluxe style trim
- Epoxy coated, fully sealed electronics
- Also fits 1973-91 Chevy & GMC dually rear

110712	Amber LED/Amber Lens - 1 Pc. / Card
110713	Red LED/Red Lens - 1 Pc. / Card
110714	Amber LED/Clear Lens - 1 Pc. / Card
110715	Red LED/Clear Lens - 1 Pc. / Card



3 Candle Power 6V Parking Light Bulb For 1928-48 Ford Car & Truck

- #63 style, 6 volt, single contact with BA15s base
- Typically used on early Fords for cowl lights, parking lights, dash lights

A1068 1 Pc. / Bulk



Black Powder Coated Magnetic Pipe Holder With Felt Liner

- No-Scratch felt lining
- Strong magnetic securely sticks to any metal dashboard
- Keep pipe within easy reach

C5016 1 Pc. / Color Box

NEW ITEMS

October 2020



Titan Cap™

Locking Gas Cap for 1947-71 Chevy and Ford

- Top quality rugged all metal military style fuel cap design
- Fits 1947-71 Chevy & GMC trucks, 1949-70 Ford cars, 1957-70 Ford trucks & Bronco
- Great for off-road enthusiasts who value extreme-armor designs and fitments
- Available in chrome plated or matte black painted finish
- Vented gas cap for vented fuel systems only

110874 Chrome - 1 Pc. / Card

110875 Black - 1 Pc. / Card

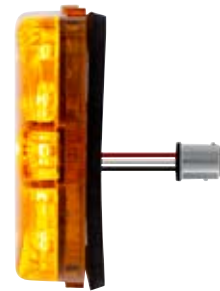

25 LED Parking/Signal Light For 1966-68 Ford Bronco

- LED Dual function, parking light and turn signal
- Super bright amber LED with amber acrylic lens
- Epoxy coated, fully sealed electronics, 1157 plug
- Fits left hand and right hand
- Gasket included

110858 1 Pc. / Card





Stainless Steel Fender Skirt Scuff Pads For 1956 Chevy Passenger Car (Pair)

- Made of top grade, rust free, T304 stainless steel
- Highly polished to a mirror like shine

C1007 1 Pair / Bulk



Stainless Steel Fender Skirt Scuff Pads For 1959 Chevy Passenger Car (Pair)

- Made of top grade, rust free, T304 stainless steel
- Highly polished to a mirror like shine

C1009 1 Pair / Bulk



Chrome Skull Shift Linkage For Harley

- Unique 3D skull design with triple chrome plating for a lasting show-bike shine
- High quality adjustable rod end ball joints to ensure smooth operation
- Includes a straight transmission lever cover and decorative acorn nuts and bolts. (Note: cover does not fit 2017+ Milwaukee-Eight with curved trans lever)
- Complete the look with Skull Swing Arm Insert Set, UP# 52010
- Fits 1986+Harley Softtail (except 18+ FXBB and FXLR), Touring and Trike models. (Does not fit 97- 99 FLSTS or models equipped with Softail Extended Reach Forward Controls.)

52009 1 Pc. / Card



Chrome Skull Swing Arm Accent Set For Harley

- Fits 2008-17 Harley-Davidson Softtail models (except FXCW, FXCWC, FXSB, and FXSBSE)
- Unique four-piece skull accent set to dress up the recessed area in the rear swing arm frame
- Easy to install with pressure sensitive adhesive mounting
- Beautifully chrome plated plastic injection molded
- Add a little attitude to your ride

52010 1 Set / Card

NEW ITEMS

November 2020



B20331



B20332



B20330 - Front Fender Brace

Steel Front Fender For 1932 Ford Car & Truck

- Quality stamped steel, exactly as original Henry!
- Fender edge bead with steel inner wire as original
- Finished with black EDP protective coating to keep your new steel fresh and rust-free
- Fits all 1932 Ford vehicles including 1932 Truck. However, fender does NOT have spare tire well.
- Available in left hand or right hand applications

B20331 L/H - 1 Pc. / Box

B20332 R/H - 1 Pc. / Box

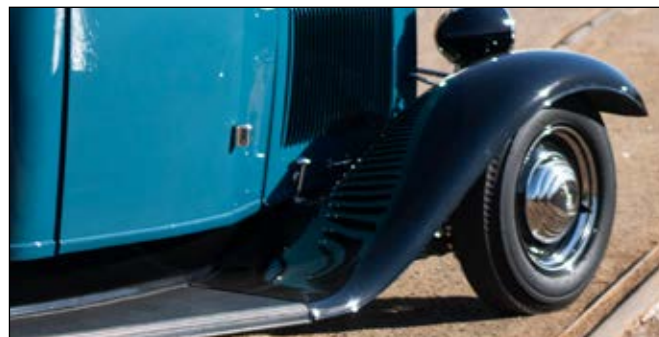

B20333



B20334

Rear Fender for 1932 Ford 5W Coupe & Roadster

- Quality stamped steel, exactly as original Henry!
- Made of excellent 20 gauge sheetmetal
- Fender edge bead with steel inner wire as original
- Precision punched quarter panel mounting holes
- Includes mounting holes for frame horn cover
- Coated with black EDP
- Sold individually, please specify left or right hand side

B20333 L/H - 1 Pc. / Box

B20334 R/H - 1 Pc. / Box





Stainless Steel Bumper End Bolts And Nuts For 1928-31 Ford Model A (Pair)

- Beautiful quality stainless steel
- Exact shape and size as the original
- 5-1/8" partial threaded with 1" long 7/16"-20 threads
- Feature original style anti-rotation key design under the head of the bolt

A6219 1 Pair / Bulk



Stainless Steel Bumper Bar Spacer For 1928-31 Ford Model A (Pair)

- Highly polished stainless steel
- A spacer between 2 bumper bars

A6220 1 Pair / Bulk



Highly Detailed Bassett Hound Ornament

- Detailed die-casting with beautiful chrome plating or matte black powder coated finish
- Easy installation on any vehicle with four mounting studs
- Approximately 7-5/8" x 4-1/8" x 7-1/4"
- Mounting hardware included
- Ideal for decorating small and personal space, home, office and garage

72003 Chrome - 1 Pc. / Color Box

72053 Black - 1 Pc. / Color Box



Cab Mount Kit For 1949-54 Chevy And GMC Truck

- Complete cab mounting kit with fasteners
- Features heavy duty reinforced rubber square pad and mounting fasteners for front cab installation
- Quality molded rubber bushing for the rear cab mount shackles
- 18 piece kit
- Includes installation diagram

110841 1 Set / Bulk



19" Double Contact Pigtail

- 18 AWG thermoplastic jacketed wires
- Tinned copper wires for better corrosion resistance
- Nylon insulation plate

A1060-4 1 Pc. / Bulk

Heated LED Headlights with Polycarbonate Lens & Housing

Available Mid-November



- Features a heating system that automatically de-ices and defrosts the headlight lens when outside temperature reaches 50 degrees Fahrenheit (10 Celsius) or below
- Integrated monitoring system to turn off heating when snow & ice has cleared from lens
- Durable corrosion resistant polycarbonate lens, housing & electronics resist shock and vibration
- Plug & play with standard H4 style connector plug for ease of installation

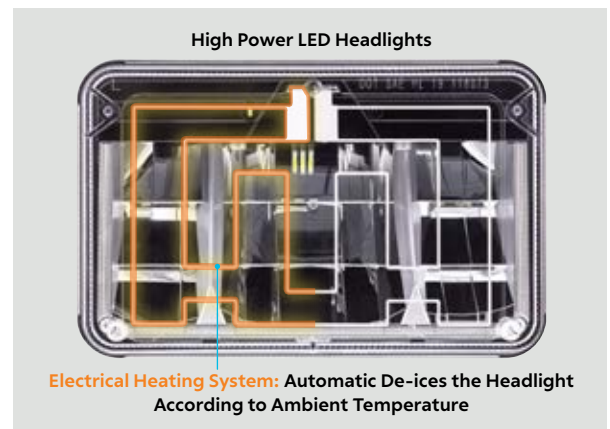

100%LED

DOT

Technical Specs

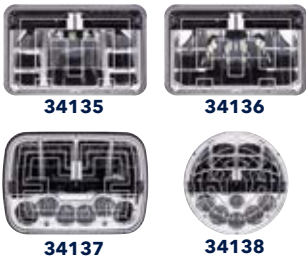

Item	Size	Beam	Lumens	Color Temp.	Voltage	Unit / Box
34135	4" x 6"	Low	750	6500 kelvin	12v/24v	1 Pc. / Card
34136	4" x 6"	High	1000	6500 kelvin	12v/24v	1 Pc. / Card
34137	5" x 7"	High/Low	1100/600	6000 kelvin	12v/24v	1 Pc. / Card
34138	7"	High/Low	950/500	5700 kelvin	12v/24v	1 Pc. / Card

Also Available:

Technical Specs



Item	Size / Color	Beam	Lumens	Watts	Voltage	Unit / Box
34131	4" x 6" / Chrome	Low	1000	20	12v/24v	1 Pc. / Color Box
34132	4" x 6" / Chrome	High	1200	24	12v/24v	1 Pc. / Color Box
34133	4" x 6" / Black	Low	1000	20	12v/24v	1 Pc. / Color Box
34134	4" x 6" / Black	High	1200	24	12v/24v	1 Pc. / Color Box

NEW ITEMS

December 2020



110093



110092



Glove Box Door For 1964-66 Chevy Truck

- Excellent stamped 20 gauge steel reproduction with all of the original contour detail
- Features precision cut lock cylinder pocket, rectangular front recess for OE Chevrolet emblem, and three OE style cup holder recesses on inner panel
- Includes door spring and welded 1/4-20 hinge nuts
- Available in beautiful chrome plated finish or black EDP coated finish

110093 Chrome - 1 Pc. / Box **(New)**

110092 Black - 1 Pc. / Box



Glove Box Door Hinge For 1964-66 Chevy Truck

- Excellent quality steel stamping
- Exact design as original with mounting holes for easy installation
- Finish with black EDP protective coating

110094 1 Pcs. / Box



Quarter Window Assembly w/Clear Glass For 1967-68 Ford Mustang Coupe

- Heavy 16 gauge stamped steel window track with mounting hardware
- Crystal clear non-tinted tempered window glass
- Beautiful polished stainless steel window frame w/ weather-strip
- Fully assembled from factory for a quick and straight forward replacement

110645 L/H - 1 Pc. / Box

110644 R/H - 1 Pc. / Box

TERMS & CONDITIONS / ORDERING GUIDELINES / FREIGHT

IMPORTANT: PLEASE REVIEW CAREFULLY

New Accounts

Initial minimum buy-in is \$2,000 (or to be determined by United Pacific Industries, UPI hereafter). All initial orders must be prepaid in advance by Cashier's Check or VISA/MC. All new/potential accounts must complete a UPI "New Customer Info/Credit Form" and follow the Dealer Qualification Instructions. Upon completion of the credit application, approved accounts will be assigned payment terms of NET 30 Days (from invoice date). Accounts denied a credit line will be required to prepay in advance by Cashier's Check or VISA/MC.

Payment Terms:

Term Accounts: Accounts with NET 30 Days terms are required to submit payment within the 30 days from the date of invoice. Acceptable forms of payment include checks, ACH (Automated Clearing House), or wire transfer.

A service charge of 1.5% per month will be imposed on invoices not paid within the 30 day term. Delinquent accounts will be required to pay Cash-In- Advance (CIA). Checks will be accepted but orders will not be released until the check is cleared by the bank. Past due invoices will delay current orders. Please check with UPI on your account status when placing an order.

Credit Cards

Accounts denied credit terms may pay by Visa or MasterCard. Credit card will be charged upon shipment. Credit card payments will not be accepted once an order has been shipped. UPI does not accept American Express or Discover card.

COD

A \$9.00 fee will be assessed per COD box for all FedEx/UPS COD shipments. Truck COD shipment fees are to be determined later by trucking company.

Returned Checks:

A \$30 NSF (Non Sufficient Fund) fee will be assessed on each incidence a check is returned to UPI.

ORDERING GUIDELINES

Placing Orders: New orders may be placed by any of the following methods

- Email: antique@upauto.com
- Fax: 888.986.6088

Telephone: In order to minimize errors, customers are encouraged to submit their orders by fax or email. Telephone orders should be limited to smaller orders such as add-ons to orders already submitted and/or fill-ins occurring between larger restocking orders.

Changes to Orders:

Whenever possible, revisions to orders - additions or deletions of items - should also be submitted via fax or email to reduce the possibility of errors.

Additions/Deletion of items will only be accepted within 48 hours after the initial order date and/or before 12:00PM on the date of the shipment. Additions of items placed after the 48 hours time period will be considered a new order and adhere to a new order freight prepaid policy. Deletions of item cannot happen after the 48 hours time period and/or after 12:00PM on the date of the shipment. Please note additions and/or deletions of items will delay the shipment date.

Canceling Orders:

Cancellation of orders must be submitted via fax or email within 24 hours of the order date. If the order has already shipped it will be the customers responsibility to return the order at the customers own expense. A restocking fee may apply, please see "Return" policy for further detail.

Backorders:

Customers have the option of having their backorders shipped or canceled. UPI will notify customer as to availability of backorders and will be able to ship any backorder items customer still needs as part of their next stock order. UPI reserves the right to cancel backorders that are 6 months or older from the initial invoice date.

Minimum Order:

A minimum order of \$50.00 is required. Orders below \$50.00 will be assessed a minimum order fee of \$10.00.

Packaging:

A 10% service charge will be added to orders with special packaging or UPC barcoding requirements.

Lead Times:

Standard lead time for all United Pacific orders is 1-3 business days from the receipt of the purchase order. Larger orders may require a lead time of up to 5 business days. Transit time of 3-5 business days must be considered when placing orders. UPI cannot be responsible for delays in shipment after an order leaves our warehouse. UPI will work to resolve delays with freight forwarding firms, however, delays do arise from time to time due to weather and unforeseen circumstances beyond UPI's control. Express order are exempted; please view Freight/Shipping Policy for further detail.

Order Confirmation:

United Pacific will acknowledge receipt of orders by email/fax/ telephone within 1 business day of receipt. If confirmation is not received, please contact UPI to ensure your order was received.

FREIGHT

Prepaid Freight:

Stock orders between \$50 and \$999.99 (US Lower 48 States), **\$50 and \$2499.99 (Alaska and Hawaii)**, **\$50 and \$1499.99 (Canada)**, [all price net US\$], will be shipped FOB Long Beach, California. Stock orders of \$1,000 (US Lower 48 States), **\$2500 (Alaska and Hawaii)**, **\$1500 (Canada)**, [based on UPI current pricing], or more will be shipped Freight Prepaid Ground to a single location only. (See exception for Oversize Items*). Express Air orders, Special Net Pricing orders, and Special Quote Pricing orders are excluded. United Pacific reserves the right to select the carrier of our choice. Customers may select the carrier of their choice at their own expense, negotiated rates and insurance. If customers elect to choose their own freight carrier, orders will be shipped via FREIGHT COLLECT.

Oversize Item Freight Policy – Applies to 1932 Ford car & truck body shell assemblies, 1932 Ford car & truck body parts such as floor assembly, roof, door, fender, quarter panel, grille, bulk rail gutter, bulk roof tack strip, chassis & frame, wheels & tire, and any exceptionally large or heavy item.

1. Freight will be prepaid by United Pacific if the total order of all items exceeds \$4,000 (US Lower 48 States) or **\$5000 (Hawaii, Alaska and Canada)**, [all price net US\$]. There will not be additional charges for these items included on the order.
2. Freight will be prepaid by United Pacific if a customer orders a total of \$2,500 (US Lower 48 States) or **\$3500 (Hawaii, Alaska and Canada)**, [all price net US\$], of PB 379 fenders, 60" or longer exhaust, and/or 18"+ Longer Saddle Boxes only. If the order is below \$2,500 (US Lower 48 States) or **\$3500 (Hawaii, Alaska and Canada)**, United Pacific will add freight charges to the order for the oversize items.

Will Call Orders:

Will Call orders can be picked up 2 - 4 hours after placing the order. Customers should always call ahead to confirm when order will be ready to pick up.

SHIPPING POLICY / CLAIMS

IMPORTANT: PLEASE REVIEW CAREFULLY

SHIPPING POLICY

International Shipments:

Shipments to locations outside the continental United States will be shipped to the customer's shipping agent or broker within the continental United States in accordance with the US freight policy. International customers will be responsible for the duties and taxes of their respective country.

Express Orders:

All express orders, such as Next Day, Second Day, 3 Day Service & Will Call, must be faxed/emailed. Order confirmation will be faxed to the customer for final approval. If confirmation is not received, please contact UPI to ensure your order was received. Customers are required to sign off on express orders and fax confirmation back to UPI. Cut off for express order is 12:00PM. Express orders received after 12:00PM may or may not ship the same day. Please call UPI to confirm projected shipping date or will call time.

Due to the high cost of express shipments, customer may request UPI to call to confirm freight charges. If customer does not request confirmation, UPI will ship the express order.

Drop Shipments:

All drop shipment orders will be assessed a 5% processing fee. Drop shipment processing fee will be automatically added to the invoice without notice. All drop shipment orders must be faxed in. No freight allowance or prepaid freight will be permitted for any drop shipments, thus, all drop ship orders, regardless of order size, are FOB Long Beach, CA.

CLAIMS

General Policy:

All claims (Shortage, Mis-Shipped, Damage, Overage, Customer Error & Billing Error) must be submitted to UPI within 3 business days of the receipt of shipment. Claims submitted beyond 3 business days of the receipt of shipment will be voided by UPI.

On all shipments, the person who signs and receives the shipment is responsible for noting on the Bill of Lading, in writing, whether any boxes arrived damaged or shorted. Failure to do so will void all claim rights between all parties. UPI will have no recourse against the trucking company if customer does not note any damages or shortages on the Bill of Lading.

The customers receiving department must count and sign for the exact number of boxes received. Failure to follow the above instructions will void all claim rights between all parties.

Shortages / Mis-Ships / Damages

While UPI strives to fill every order with 100% accuracy, on occasion an item may get shipped in error or get damaged during shipping. In the event this occurs, please follow the process below. Note: This type of claim must be reported to UPI within three (3) business days of receiving the order.

1. Contact the United Pacific office to initiate the claim. To make it easy for you we have two acceptable methods for requesting the claim:

• Email: returns@upauto.com

• Fax: 888.986.6088

*** Note: To ensure you receive a timely credit, we cannot accept claim requests by phone.**

2. You will be required to provide the following information:

- Your business name
- Contact name and telephone number (in case we have questions)
- Date the order was received
- A copy of the Packing List / Invoice noting the item number and quantity that was shipped in error or damaged during shipping.
- Special instructions you have for us.

3. UPI will send a return label so you can ship the items back.

4. Once we receive the miss-shipped/damaged item(s) a credit will be issued to your account on the next billing cycle.

5. Shortages will be credit to the Customers' account, unless customer would like the shortages replaced.

Overages:

UPI strives to provide our customers with the best customer service and products, in turn we would greatly appreciate any help from customer in notifying UPI of any shipping overages. Customers will be offered the option of retaining the merchandise or returning the merchandise to UPI at UPI's expense. If the items are to be returned, an RMA number and return shipping label will be provided.

Customer Errors:

Any item or quantity ordered in error by the customer may be returned by contacting UPI for a RMA No.

1. To make it easy for you we have two acceptable methods for requesting the RMA:

• Email: returns@upauto.com

• Fax: 888.986.6088

*** Note: To ensure you receive a timely RMA credit, we cannot accept RMA requests by phone.**

2. You will be required to provide the following information.

- * Your business name
- * Contact name and telephone number (in case we have questions)
- * A list of the items number and quantity ordered in error
- * Special instructions you have for us

3. UPI will review the request to ensure the products are within the return period.

4. Once we have validated the request, United Pacific will issue an RMA number to the customer. In issuing the RMA approval, the following conditions will apply :

- Returned items are subject to a 20% re-stocking fee.
- Return shipping costs are the responsibility of the customer.
- Items must not have any retail/price sticker on exterior packaging or they will be returned to the customer at customer's expense and no credit given.
- Items must be in good condition with original packaging intact or they will be returned to the customer at customer's expense and no credit given.
- Allow up to 30 days for the credit to be issued from the time the returned items are received.

Billing Errors:

Billing errors should be reported to UPI within 3 business days of invoice receipt. Customers are asked to provide the invoice number, part number, and quantities in question. Once verified, UPI will issue a credit or an invoice for the difference in billing error.

WARRANTY POLICY / RETURNS

IMPORTANT: PLEASE REVIEW CAREFULLY

WARRANTY POLICY

General Policy:

UPI offers a NO HASSLE WARRANTY RETURN policy to all our customers. Warranty claims can only be submitted through an authorized UPI Distributor. UPI warranty is not transferable and applies to the original installation and purchase only. In no event shall UPI be liable for incidental or consequential damages, nor shall UPI be liable for any claims or damages arising out of or connected with the UPI warranty exceed the purchase price of the products. There are no warranties, expressed or implied (including any warranty of merchantability or fitness) that extend beyond this warranty. The warranty does not apply to costs associated with the loss of use of the product, loss of time, inconvenience, commercial loss, incidental or consequential damages. UPI reserves the right to alter the designs of products without assuming any obligation to modify previously manufactured products and will only replace warranted products with redesigned products.

Warranty does not apply to merchandise that has been drilled, cut, welded, modified in any way or installed contrary to normal installation and usage. In addition, UPI cannot be held liable for damages caused by road hazards, accidents, misuse, neglect, abuse or corrosive environments including acid washes and highway snow/ice chemicals which can cause discoloration and corrosion in aluminum, chrome, stainless steel and light products. UPI reserves the right to credit returned merchandise at the initial purchase price or at the current selling price, which price ever is lower.

Aluminum / Chrome / Stainless Steel Products:

All aluminum, chrome, and stainless steel products carry a limited 6 month warranty (from invoice date) against defects in material or workmanship.

Lighting Products:

Incandescent

All incandescent lighting products carry a limited 12 month warranty (from invoice date) against defects in material or workmanship. The limited 12 month warranty does not apply to several applications, such as, buses, construction equipment, and off road vehicles.

LED

All LED lighting products carry a specific Limited Warranty (from invoice date) against defects in material or workmanship.

- LED with vehicle specific application is limited lifetime warranty to an original purchaser with receipt. Examples of lifetime warranty product: CTL5720LED CTL5720LED for 1957 Chevy, FTL3201LED-L for 1932 Ford.
- LED Marker, 2", 2-1/2", 4", 7", Oval & Square Lights - Varies from 2 years to 10 years to Limited Lifetime, depending on specific item. The housing, bezel or mounting base on any light made from Chrome/Stainless carries a 6 month limited warranty.
- LED Cab Lights and Kits, Double/Single Stud Turn Signal and PB/KW/FL/VL or non-make Turn Signals and any/all Strip Lights - Varies from 2 years to 10 years to Limited Lifetime, depending on specific item. The housing, bezel or mounting base on any light made from Chrome/Stainless carries a 6 month limited warranty.
- LED Beacon, Driving, Headlights, Work & Warning Lights - Varies from 6 months to 3 years. The housing, bezel or mounting base on any light made from Chrome/Stainless carries a 6 month limited warranty.
- All LED Accessory Lights (Honda, Stainless Steel Double/Single face Lights, Interior Lights, License Plate Lights, and any Accent Lights. The housing, bezel or mounting base on any light made from Chrome/Stainless carries a 6 month limited warranty.

RETURNS

General Policy:

All returns must be authorized by UPI. All return requests must be faxed or e-mailed (returns@upauto.com) A RMA number (Return Merchandise Authorization Number) will be provided. Returns not possessing a valid RMA number are subject to rejection and will be returned to sender at the customer's expense. All customers are encouraged to use the Warranty RMA Claim Form.

Defective Goods / Warranty Return:

UPI offers our customers a No Hassle Warranty Return. Please follow the instructions below for requesting a RMA for defective goods:

1. If any warranty issues occur, simply contact the UPI for RMA number. To make it easy for you we have two acceptable methods for requesting the RMA:
 - Email: returns@upauto.com
 - Fax: 888.986.6088

*** Note: To ensure you receive a timely RMA credit, we cannot accept RMA requests by phone.**
2. You will be required to provide the following information:
 - Your business name
 - Contact name and telephone number (in case we have questions)
 - A list of the defective item number and quantity with the nature/ reason of the defect
 - Special instructions you have for us
 - The enclosed fax form may be used for your convenience to request an RMA
3. UPI will review the request to ensure the products are within the stated warranty period.
4. Once we have validated the warranty items, a RMA confirmation, listing the items and cost will be faxed to the customer within 3 business days. UPI will process the credit to your account within 30 days.

Note: There will be no need to return the warranty product to us. However, from time to time, UPI may require some warranty products to be shipped back so we may analyze the cause of the failure. All warranty products that are required to be shipped back will be freight prepaid by UPI.

Stock Return

United Pacific Industries encourages all customers to regularly monitor the sales volume and stock level of their inventory items. As sales trends may slow the movement of specific items, our hope is that those items are featured as "close-out specials" as to minimize stock returns. We also understand that the customer, from time to time, may accumulate over-stock items and desire to return those. Therefore, we have adopted the following policy below.

NOTE:

- Items must have been purchased by the dealer requesting the stock return.
 - Items must have been purchased within the preceding 12 months.
 - Items that have been discontinued will not be considered for return.
1. Contact the United Pacific office for RMA number. We have 2 acceptable methods for requesting the RMA:
 - Email: returns@upauto.com
 - Fax: 888.986.6088

***Note: To ensure you receive a timely RMA credit, we cannot accept RMA requests by phone.**

RETURNS / CATALOGS / DISCLAIMER

IMPORTANT: PLEASE REVIEW CAREFULLY

2. You will be required to provide the following information:

- Your business name
- Contact name and telephone number (in case we have questions)
- A list of defective items: Item numbers and quantity of each
- Special instructions you have for us

3. Your claim will be reviewed within 5 business days and you will be contacted by your sales representative who will discuss solutions to liquidate these slow moving items.

4. In the event United Pacific and the customer agree to a credit in lieu of returning the items, this credit will be issued within 10 business days.

5. In the event items are returned by the customer, United Pacific will issue an RMA number to the customer. In issuing the RMA approval, the following conditions will apply:

- Returned items are subject to a 20% re-stocking fee.
- Return shipping costs are the responsibility of the customer.
- Items must not have any retail/price sticker on exterior packaging or they will be returned to the customer at customer's expense and no credit given.
- Items must be in good condition with original packaging intact or they will be returned to the customer at customer's expense and no credit given.
- Allow up to 30 days for the credit to be issued from the time the returned items are received.

6. Stock returns may be requested throughout the year and are subject to final approval by United Pacific.

Closeout/Discontinue Items:

UPI will not warranty or accept returns on Closeout/Discontinue items.

Procedure:

An inventory of the merchandise being returned must accompany each return. The RMA number should be prominently displayed on each carton/box.

All Returns must be returned freight prepaid.

Ship Returns to:

United Pacific Industries
Attn: Returns Department
3788 E. Conant St.
Long Beach, CA 90808

RMA's:

Outstanding RMA's will be automatically canceled if not used within 30 days of issuance.

CATALOGS

General Policy:

UPI will send a set of catalogs and price lists upon the arrival any new catalogs and price list. Included in the mailing will be a Catalog Order Form in which customers can request additional copies.

Catalog/CD Request:

UPI provides additional catalogs/CD's to our customers free of charge. Customer must submit their request on a UPI Catalog Order Form or add the request to their regular restocking order. Requests for additional catalogs/CD's should be submitted along with the regular restocking orders to avoid additional freight charges. Due to the availability of catalogs/CD's, customer's request may be limited to certain quantity. Catalogs/CD's will be shipped along with the customers' order. Customer may request the catalogs be shipped separately, but customer will be responsible for the freight charge.

Picture Request

All UPI item pictures are taken professionally by our marketing department. Item pictures can be downloaded online at www.upauto.com. Item pictures not posted online can be requested by sending an email to [e-mail graphic@upauto.com](mailto:graphic@upauto.com). All picture requests must state the item no and the format of the picture file, i.e jpeg or high resolution. UPI has over 20,000 SKU's and therefore does not have a CD with all the items.

DISCLAIMER

United Pacific Industries reserves the right to amend or update our Policies & Procedures without notice.

United Pacific Industries is not responsible for typographical, product information or print errors. Specifications on this catalog may be changed without advance notice. Products may look different from those in the photos on this catalog due to printing quality.

RMA FORM SAMPLE

 United Pacific 3788 CONANT STREET LONG BEACH, CA 90808 DIRECT (562) 425-0288 TOLL FREE (800) 327-1288 FAX (562) 994-6288 UPW@UP.COM	DEFECTIVE GOODS / WARRANTY CLAIM FORM
	Date: _____ Company Name: _____ Address: _____ City, State, Zip: _____ Contact Name: _____ Phone Number: _____ Fax Number: _____ Email: _____

List defective items below:

Item#	Qty	Description	Reason for Defect	Date Sold to Customer

Any special notes / instructions for United Pacific (list here):

File your claim at:
by email - uprma@upacific.com
by fax - (562) 994-6288

Internal Use Only	
Date Received: _____	Final RMA: _____
RMA Approval Date: _____	Credit Amount: _____
RMA Number: _____	Approved by: _____

CALIFORNIA PROPOSITION 65 WARNING



WARNING: Cancer & Reproductive Harm-
www.P65Warnings.ca.gov

PRODUCT INDEX

ITEM#	PAGE#	ITEM#	PAGE#	ITEM#	PAGE#
23497	14	110217	12	110899	18
23498	14	110249	5	30610B	6
23499	14	110250	5	A1060-4	26
31050	19	110265	15	A1068	22
34131	20	110446	12	A6219	26
34131	27	110480	11	A6220	26
34132	20	110481	11	ACBR02	19
34132	27	110516	4	ANF1215	13
34133	20	110588	8	ANF1216	13
34133	27	110589	8	ANF1217	13
34134	20	110644	28	ANF1218	13
34134	27	110645	28	ANF1219	13
34135	27	110697	20	B20331	25
34136	27	110712	22	B20332	25
34137	27	110713	22	B20333	25
34138	27	110714	22	B20334	25
36446	17	110715	22	B21507	21
36447	17	110735	4	C1007	24
36448	17	110736	4	C1009	24
36452	13	110737	4	C5016	22
36454	6	110738	4	C555601	11
36455	6	110772	16	C687201	7
36456	6	110773	16	C7016	21
36457	6	110774	16	F646605	21
39065	12	110775	16	F646606	21
39909	11	110776	17	S2007LED	15
50088	10	110777	17	S2007LED-A	15
50089	10	110804	7	S2007LED-W	15
50148	15	110804	16		
50149	15	110805	7		
50187	15	110805	16		
52009	24	110806	11		
52010	24	110825	7		
72003	26	110826	7		
72046	9	110827	7		
72047	9	110837	14		
72053	26	110838	14		
95002	19	110840	21		
99060	17	110841	26		
99086	21	110842	6		
99193	11	110858	23		
99194	11	110860	9		
99195	11	110861	9		
99196	15	110862	9		
110092	28	110863	9		
110093	28	110864	9		
110094	28	110867	8		
110147	12	110868	5		
110148	12	110870	18		
110149	12	110871	18		
110168	12	110874	23		
110203	15	110875	23		
110204	15	110876	8		
110205	15	110877	5		
110205	15	110878	5		
110206	7	110884	8		
110207	10	110887	18		
110210	15	110888	18		
110210	15	110896	14		
110211	15	110897	20		
110211	15	110898	20		



United Pacific

UPauto.com | T 866.327.5288 | F 888.986.6088

© 2021 United Pacific Industries. All Rights Reserved. Products not shown to scale. Specifications subject to change without notice.

ANF1220

2020 Classic New Item Flyer Collection



710270061983