



United Pacific

# ANTIQUE

2018 New Product Collection



**HOW TO ORDER**

To order from United Pacific Industries, you must be an authorized dealer, distributor or OEM. If you are not authorized to stock and sell United Pacific products, you must order through an authorized dealer. Please call 866.327.5288 for more information.

**CONTACT US**

-  8 am - 4:30 pm PST
-  866.327.5288 / 562.425.5588
-  888.986.6088 / 562.425.3632
-  Antique@upauto.com
-  UPauto.com
-  3788 E. Conant St., Long Beach, CA 90808



*United Pacific partnered with Maxluder Brothers for the 2018 SEMA Show, to build this custom '74 Ford Bronco using our steel replacement panels and LED lighting.*



*The official vehicle of this year's Street Rodder Road Tour is this custom 1932 Ford Truck, designed and built by Hot Rod's by Dean using United Pacific's 1932 Ford Truck body cab, door shells, parts and accessories.*

**QUALITY**

With over 30 years of experience in the automotive aftermarket industry, United Pacific Industries understands the rigors and stresses that our products are subjected to on the road. It is our mission to provide our customers with products of superior quality and reliability. In achieving this goal, United Pacific only partners with manufacturing facilities that conforms to our quality control requirements and standards. Our manufacturing partners meet or exceed ISO-9001 requirements. In addition, United Pacific's manufacturing partners must be equipped on site to perform the following quality assurance tests and maintain a track record of consistent quality and low product failure rate.

- |                  |                    |                    |
|------------------|--------------------|--------------------|
| • Aging Test     | • Photometric Test | • Shock Test       |
| • Air Tight Test | • Pull Force Test  | • Temperature Test |
| • Dust Test      | • Rain Test        | • Humidity Test    |
| • Flux Test      | • Salt Spray Test  | • Vibration Test   |

Furthermore, our internal quality control structure allows us to function as the final quality control station prior to shipping. With the assistance of 3D computer technology, United Pacific can adhere to strict quality control standards during prototype creation and the production process. Our engineers and technicians perform a battery of tests to ensure that our products meet the demands of today's drivers and our goal to be first in quality.

**INNOVATION**

Known as the leader in innovation, United Pacific is dedicated to be the first to bring new and exciting products to the market. United Pacific's global expertise allows us to search the globe for new ideas and concepts. Not only do we search the globe for new products, United Pacific invest a significant amount of resources into our own research and development efforts. With the assistance of advance 3D scanning technology, our engineers and designers can acquire accurate and precise data in seconds. The 3D data allows United Pacific to verify designs, perform quality assurance tests, and reverse engineer with unprecedented speed and accuracy. Digital inspection contributes to the early detection of shape problems, provides rapid feedback on design, and eliminates unnecessary work in downstream processes. Our rapid prototyping facility permits us to have a concept-to-shelf time of less than 5 months. In addition, United Pacific's 3D printing capabilities permit our designers to have physical models of their design concepts in hours. The physical models allow our designers and marketing staff to evaluate and test the viability of different design ideas. Our rapid prototyping facility allow United Pacific to compress design cycles, improve manufacturing planning, shorten concept-to-shelf time, most importantly, generate new and innovative products.

**DESIGN**

Located near some of the nation's most progressive automotive design centers, United Pacific established the UP Design Studio in 2002 to consolidate our position as the design leader in the automotive industry. UP Design Studio utilizes the latest generation of computer aided design (CAD) and studio/graphic software. The design studio is equipped with the newest computers and rapid prototyping systems. In addition, UP Design Studio is staffed by graduates from the nation's most prestigious design colleges. Unlike our competitors, United Pacific's design and manufacturing capabilities mean that we carry more new and original items than our competitors. The establishment of the design studio will enable us to generate even more new products with significant shorter concept-to-shelf time. The reduction in development cost mean that we can develop products utilizing design based development processes. Design based product development allows United Pacific to create new product concepts based on designs incorporating driver demands and needs instead of economic considerations. United Pacific's emphasis on design distinguishes and positions us ahead of our competitors.



## WARRANTY

With LED (Light Emitting Diodes) rated at 100,000 hours of operation and solid-state construction, United Pacific's LED lights are extremely reliable and durable. Purchase with confidence, United Pacific offers a complete line of LED lighting products with extended or limited lifetime warranties. Please see the warranty policy page for more details.

## INVENTORY AND SHIPPING

United Pacific carries over 20,000 items in our California distribution center. No other company in the heavy duty trucking industry can match United Pacific in the variety and range of in-stock inventories. With an order fill rate of over 98.5%, United Pacific is the largest and most reliable supplier in the industry. Our shipping department ships 96.8% of all orders within 24 hours and 98.9% within 48 hours. United Pacific's vast inventory and prompt shipping has made United Pacific the only source for our customer's chrome and lighting needs.



## HARD AT WORK FOR THE ENVIRONMENT



**United Pacific**  
**132,000** sq ft  
**Distribution Center**  
**Long Beach, CA**

**100%** reduction in potable water used for landscaping  
**40%** reduction in total energy use due to high-efficiency mechanical and lighting systems  
**82%** of construction waste was diverted from landfills

## LEED ACCOMPLISHMENTS

### Sustainable Sites

- On-site bicycle storage, showers and changing areas for company employees.
- Preferred parking for low-emitting, fuel-efficient and carpool vehicles.
- Stormwater is infiltrated on-site and treated to remove contaminants to reduce environmental impact on local waterways.

### Water Efficiency

- In addition to using reclaimed water, drought-tolerant plants and a high-efficiency irrigation system were installed to reduce the use of potable water for irrigation by 100%.

### Energy and Atmosphere

- Efficient HVAC equipment and a lighting system with daylight controls reduces energy consumption by over 30%.
- Enhanced commission verifies that the building's energy and water-related systems are performing as intended by the initial design.

### Indoor Environmental Quality

- Building ventilation systems was designed to provide enhanced levels of fresh outside air to building occupants.
- Interior finishes (plants, sealants, adhesives, coatings, carpet systems and composite wood) were selected with low levels of volatile organic compounds (VOCs) to reduce indoor air contamination.



# NEW ITEMS

December 2018



WIDE ANGLE OPTICS



Available with LED Turn Signal

## Mustang LED Mirror



### Exterior Mirror for 1964.5-66 Ford Mustang

- Original fit for 1964.5-66 Ford Mustang
- Chrome die cast mirror arm and head
- Right hand available with convex mirror for wide angle visibility
- Available with led turn signal arrow for safety and visibility when changing lanes
- Mounting pad and mounting screws included

<b>F646601</b>	L/H & R/H	1 Pc. / Color Box
<b>110174</b>	L/H w/LED Turn Signal	1 Pc. / Color Box
<b>110175</b>	R/H w/Convex Mirror	1 Pc. / Color Box
<b>110176</b>	R/H w/Convex Mirror & LED Turn Signal	1 Pc. / Color Box

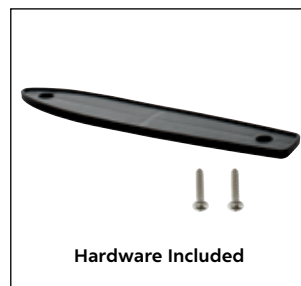

NEW COLOR PACKAGING

\*LED Turn Signal for Auxiliary/Off-Road Only. Early 1964-65 Mustang with Single Dashboard Turn Indicator Will Require Modification of the Indicator Bulb



110292



110293

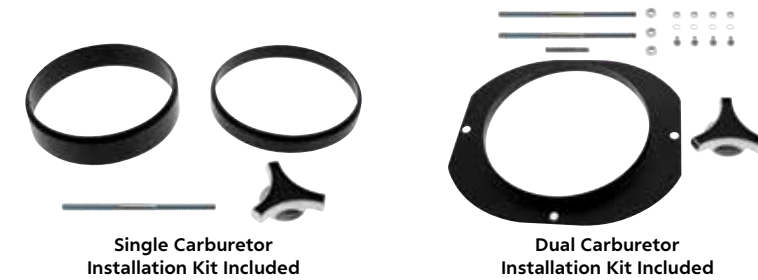

Single Carburetor Installation Kit Included

Dual Carburetor Installation Kit Included

### Oval Aluminum Air Cleaner - with Mustang Script

- Complete assembly with top, base & air filter element
- Measures 21" long, 10" wide, 2-1/4" tall (2-3/8" tall at carb flange)
- Includes die cast chrome plated 3-wing nut & mounting hardware

**110292** Single 4-Barrel - 1 Pc. / Box

**110293** Double 4-Barrel - 1 Pc. / Box

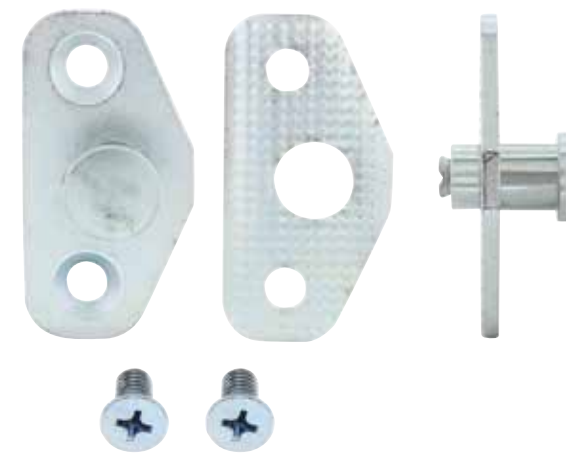

### Door Striker Kit for 1966-67 Ford Bronco - Also Fits 64-66 Mustang

- Heavy duty steel reproduction of the original striker
- Round latch stud
- Includes one shim and two 5/16 - 18 screws
- Fits both the left or right hand side

**110476** 66-67 Bronco - 1 Kit / Bag



### Door Striker Kit for 1968-77 Ford Bronco

- Heavy duty steel reproduction of the original striker
- Original style oval latch stud
- Includes two shims and two 5/16 - 18 screws
- Fits both the left or right hand side

**110477** 68-77 Bronco - 1 Kit / Bag

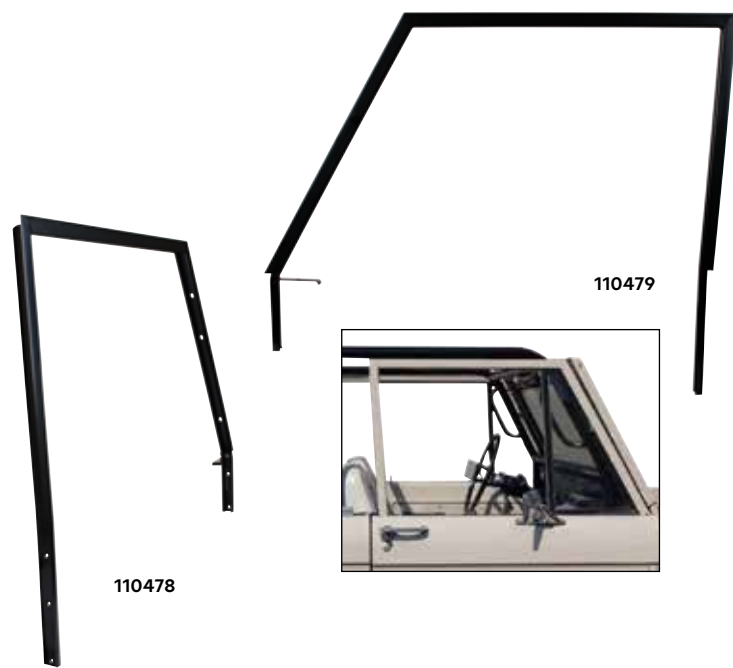

110479

110478

#### Black Door Window Frame for 1966-77 Ford Bronco

- Excellent steel reproduction with original 196-68 removable frame style
- Black EDP coated
- Thread plated welded to frame for easy mounting to door shell
- OEM #: c6tz-9722220-a / c6tz-9722221-a
- Sold individually, please specify LH or RH side

110478 R/H - 1 Pc. / Box

110479 L/H - 1 Pc. / Box



#### High Power H4 LED Bulb with Fan

- 23W low beam application, 25W high beam application
- 1800 Lumen low beam output
- 2400 Lumen high beam output
- Includes driver/controller for easy installation, replaces any h4 bulb. Driver/controller is approximately 2 3/16" L x 7/8" W x 5/8" H

36512 1 Pair / Color Box



NEW COLOR PACKAGING

COMPETITION SERIES



1,020 LUMENS

10v-30v MULTIPLE VOLTAGE

#### 12 High Power LED 7" Combo Light Bar

- 12 High power LED combo light
- 4 inner LEDs (spot) / 8 outer LEDs (flood)
- 12 V application, IP 67 rated
- 3 Year Warranty

36599 1 Pc. / Color Box



#### United Pacific Banner

- United Pacific Banner - 48" x 36"

99053 1 Pc. / Bulk

# NEW ITEMS

February 2018



#### Deluxe Heavy Duty Vehicle Positioning Jack

- Ideal for moving vehicles in garages, workshops and areas with limited space
- Hydraulic ram and pump provides easy lifting action
- Accommodates most automotive tires up to 12" wide
- Steel frame construction with steel tire rollers, 1500 lb. Capacity
- 6000 Lb. Total vehicle capacity with 4 jacks
- High quality polyurethane casters for floor protection from damage (2 with toe locks)
- Sold 1 per box, two jacks are needed per axle
- Optional storage cart available: item # 98998

98999 1 Pc. / Color Box

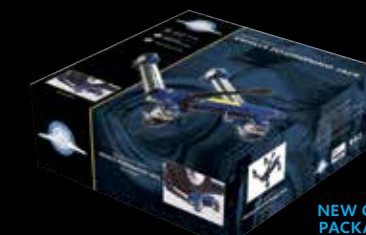

NEW COLOR PACKAGING

#### Storage Cart for Vehicle Positioning Jacks

- Secure and store up to 4 vehicle positioning jacks
- Four hard rubber 360 degree swivel ball bearing wheels for easy maneuvering
- Positioning jack available separately: item # 98999

98998 1 Pc. / Box

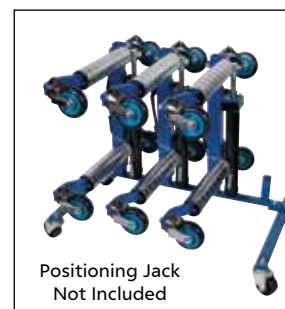
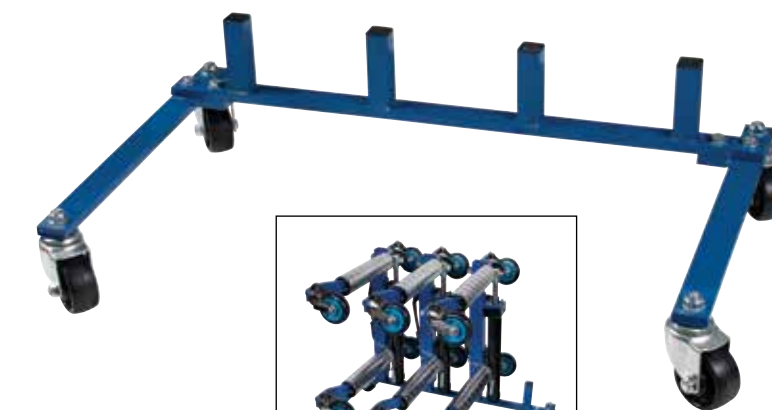
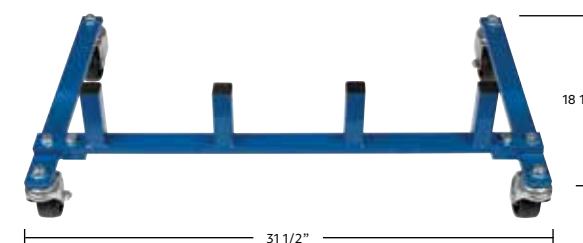

Positioning Jack Not Included



### 36 White LED Back-Up Light for 1971 Chevelle SS & Malibu

- 36 Super bright LEDs, complete with polycarbonate lens and stainless steel trim
- Epoxy coated, fully sealed electronics
- Easy electrical connection with 1156 plug, no modification to vehicle
- **Lifetime Warranty**

**CBL7101LED-L** L/H - 1 Pc. / Card

**CBL7101LED-R** R/H - 1 Pc. / Card



### 36 White LED Back-Up Light for 1972 Chevelle SS & Malibu

- 36 Super bright LEDs, complete with polycarbonate lens and stainless steel trim
- Epoxy coated, fully sealed electronics
- Easy electrical connection with 1156 plug, no modification to vehicle
- **Lifetime Warranty**

**CBL7201LED-L** L/H - 1 Pc. / Card

**CBL7201LED-R** R/H - 1 Pc. / Card



### LED Back-Up Light for 1957 Chevy

- 28 Super bright LEDs, complete with polycarbonate lens
- Epoxy coated, fully sealed electronics
- Easy electrical connection with 1156 plug, no modification to vehicle
- **Lifetime Warranty**

**110221** 1 Pc. / Card



### Vent Window Assembly for 1966-77 Ford Bronco

- Beautifully chrome plated
- Fully assembled and ready to install
- Sold individually, please specify L/H or R/H

**110218** R/H - 1 Pc. / Box

**110219** L/H - 1 Pc. / Box



### 46 Red LED Tail Light for 1971 Chevelle SS & Malibu

- 46 Super bright LEDs, complete with polycarbonate lens and stainless steel trim
- Dual function with tail light and bright stop/turn signal
- Epoxy coated, fully sealed electronics
- Easy electrical connection with 1157 plug, no modification to vehicle
- Recommended upgrade under dash flasher to 90652 led flasher
- **Lifetime Warranty**

**CTL7101LED-L** L/H - 1 Pc. / Card

**CTL7101LED-R** R/H - 1 Pc. / Card

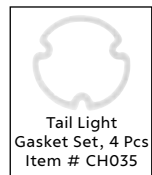

### 46 Red LED Tail Light for 1972 Chevelle SS & Malibu

- 46 Super bright LEDs, complete with polycarbonate lens and stainless steel trim
- Dual function with tail light and bright stop/turn signal
- Epoxy coated, fully sealed electronics
- Easy electrical connection with 1157 plug, no modification to vehicle
- Recommended upgrade under dash flasher to 90652 led flasher
- **Lifetime Warranty**

**CTL7201LED-L** L/H - 1 Pc. / Card

**CTL7201LED-R** R/H - 1 Pc. / Card



### Car Gas Tank Cover 1933-34 Ford Passenger

- High quality 20 gauge stamped steel with wire beaded edge as original
- Features all of the original contour detail & mounting holes except gas neck hole & bumper bracket holes
- Coated in black EDP

**B24035** 1 Pc. / Box



### United Pacific 32 Ford Truck Poster

- Beautiful photography of our new 1932-34 Ford truck product line
- Dimension approximately = 24" W x 18" L

**99112** 1 Pc. / Bulk

# NEW ITEMS

March 2018



## Door Shells for 1966-67 Ford Bronco

- Die stamped with high quality 20 gauge sheet metal
- Features all of the original 66-67 contour detail
- Black EDP coated
- Sold individually, please specify L/H or R/H

**110370** 66-67 R/H - 1 Pc. / Box

**110371** 66-67 L/H - 1 Pc. / Box



## Firewall Kit for 1966-77 Ford Bronco

- Made with excellent quality 18 gauge sheet metal
- Features all original 1966 contour detail and cutouts
- Coated with weldable primer
- Kit includes: left & right kick panel, left & right dash panel, upper & lower dash panel, cowl lower panel
- User assembly is required
- Oversize freight policy

**110535** 1 Kit / Box

## Door Shells for 1968-77 Ford Bronco

- Die stamped with high quality 20 gauge sheet metal
- Features all of the original 68-77 contour detail
- Black EDP coated
- Sold Individually, Please Specify L/H or R/H

**110372** 68-77 R/H - 1 Pc. / Box

**110373** 68-77 L/H - 1 Pc. / Box



## Firewall Assembly for 1966-77 Ford Bronco

- Die stamped with high quality 18 gauge sheet metal
- Features all original 1966 contour detail and cutouts
- Coated with weldable primer
- Fully assembled for quick drop in restorations
- Oversize freight policy

**110369** 1 Pc. / Box



## Extended Eleanor Style All Steel Hood for 1967 Ford Mustang

- All-Steel "Eleanor" Style Hood which is extra long at the front to match up with the Eleanor/Shelby style nose for those converting over to the "Eleanor" style Mustang
- This is not a bolt-on stock replacement hood and you must have the Eleanor/Shelby style extended nose for this hood to fit properly
- Can also be used on 1968 Mustang if 1967 extended nose is used
- Black EDP coated
- Oversize freight policy

**110648** 1 Pc. / Box



Rear View

## Eleanor Style Fiberglass Front Valance for 1967-68 Ford Mustang

- High Quality Fiberglass Construction
- Accurate Reproduction with All Original Contour Detail and Cutouts
- Iconic Eleanor Style
- Oversize Freight Policy

**110650** 1 Pc. / Box



## Shelby Style Quarter Panel Side Scoop - Upper Pair for 1967-68 Ford Mustang Fastback

- Die stamped with high quality sheet metal
- Features accurate contour detail
- As original, has mounting studs for easy installation
- Fits 1967-68 Fastback only
- Sold in pairs

**110651** 1 Pair / Box



## Shelby Style Quarter Panel Side Scoop - Lower Pair for 1967-68 Ford Mustang

- Die stamped with high quality sheet metal
- Features accurate contour detail
- As original, has mounting studs for easy installation
- Great upgrade for any 1967-68 Mustang
- Fits all 1967-68 Fastback, Convertible and Coupe
- Also fits "California Special" Mustang
- Sold in pairs

**110652** 1 Pair / Box



### Chrome Mirror for Chevy / GMC Full Size Truck and Van

- Exterior rectangular rear view mirror
- Includes mounting pad and mounting hardware
- Can be used for L/H or R/H

**60050** 1 Kit / Box



### Glove Box Door Kit for 1955-59 Chevy & GMC 2nd Series Truck

- Excellent steel reproduction with high quality 22 gauge sheet metal
- Heavy gauge arm brackets with 10-32 tapped holes for easy installation
- 10-24 Caged nuts for quick hinge mounting
- Quality steel hinge with pre-installed springs
- 10-32 & 10-24 Screws included
- Black EDP coated

**110338** 1 Pc. / Box



### Chrome Headlamp Bezels for 1963 Chevy Truck

- Beautifully chrome plated with triple plating process
- #8 Oval head sheet metal screws included
- Sold in pair

**110429** 1 Pair / Box



### Steering Wheel Hub Adapter Kit for GM

- Use with all 3-bolt mount steering wheels
- Fits wide variety of gm vehicles 1949-1980
- Includes splined hub, horn contact plate and hardware
- Horn button cap sold separately

**110314** 1 Pc. / Box



### 6 High Power LED 6418 / 6461 36 mm Light Bulb (2 Pack)

- Festoon style light bulb with 6 high power micro SMD LEDs
- Specially designed LED bulb projects light 160 degrees

**36591** Amber - 2 Pcs. / Card

**36592** Blue - 2 Pcs. / Card

**36593** Red - 2 Pcs. / Card

**36594** White - 2 Pcs. / Card



### 8 High Power LED 211-2 Light Bulb (2 Pack)

- 211-2 Festoon style light bulb with 8 high power micro SMD LEDs
- Specially designed LED bulb projects light 160 degrees

**36595** Amber - 2 Pcs. / Card

**36596** Blue - 2 Pcs. / Card

**36597** Red - 2 Pcs. / Card

**36598** White - 2 Pcs. / Card

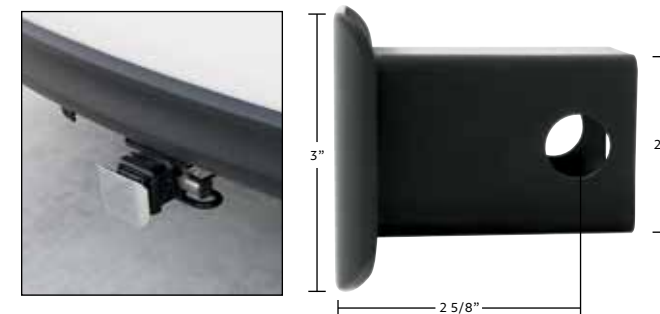

### 2" Hitch Cover

- Fits standard 2" x 2" tow hitch receivers
- Mounts in place with standard locking hitch pin & clip (sold separately)
- Keep out dirt and debris, super clean look

**77007** Chrome - 1 Pc. / Card

**77008** Black - 1 Pc. / Card

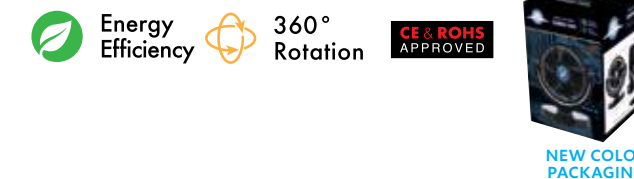

### Mini Cooling Turbo Fan

- Complete and ready to install in cars, trucks, vans, motor homes, boats or recreation vehicles
- 360° rotation, universal positioning
- Improve vehicle ventilation, air circulation, and window de-misting
- Easy installation, double sided tape included
- Built-in car charger head
- Comes with fuse inside the plug
- 12V DC input/0.33 Amps, total power consumption: 4w
- Noise: <45db
- Power cord length: 10 feet

**40847** 1 Pc. / Color Box



# NEW ITEMS

April 2018



## 18 GAL Tin Sheet Fuel Tank for 1947-55 Chevy & GMC 1st Series Truck

- Die stamped with Ni-Terne treated steel sheet
- Has all original contour detail and mounting holes
- Machine welded for an even and complete seal

**110687** 1 Pc. / Box

## 18 GAL Tin Sheet Fuel Tank for 1955-59 Chevy & GMC 2nd Series Truck

- Die stamped with Ni-Terne treated steel sheet
- Has all original contour detail and mounting holes
- Machine welded for an even and complete seal

**110688** 1 Pc. / Box

## 20 GAL Tin Sheet Fuel Tank without EVAP for 1967-72 Chevy & GMC C/K Series Truck

- Die stamped with Ni-Terne treated steel sheet
- Has all original contour detail and mounting holes
- Machine welded for an even and complete seal
- For truck models without EVAP

**110685** 1 Pc. / Box

## 20 GAL Tin Sheet Fuel Tank with EVAP for 1970-72 Chevy & GMC C/K Series Truck

- Die stamped with Ni-Terne treated steel sheet
- Has all original contour detail and mounting holes
- Machine welded for an even and complete seal
- For truck models with EVAP

**110686** 1 Pc. / Box

## 16 GAL Steel Zinc Plated Fuel Tank for 1973-81 Chevy & GMC C/K Series Truck

- Die stamped with Ni-Terne treated steel sheet
- Has all original contour detail and mounting holes
- Machine welded for an even and complete seal

**110683** 1 Pc. / Box



## 20 GAL Fuel Tank with Drain Plug for 1969 Ford Mustang

- Made with corrosion resistant stainless steel sheet
- Die stamped with all original contour and mounting holes
- Machine welded to ensure proper seal
- Stainless steel drain plug pre-installed
- OEM #: C9ZZ-9002-A

**110680** 1 Pc. / Box



## 22 GAL Fuel Tank with Drain Plug for 1970 Ford Mustang

- Made with corrosion resistant stainless steel sheet
- Die stamped with all original contour and mounting holes
- Machine welded to ensure proper seal
- Stainless steel drain plug pre-installed
- For Mustang models without EVAP
- OEM #: D0ZZ-9002-A

**110682** 1 Pc. / Box



## Fuel Tank Sending Unit for 1970 Ford Mustang

- Made with corrosion resistant stainless steel sheet
- Brass float just like the original
- Resistance output: 8.5 - 77 Ohms
- Includes rubber seal, stainless steel lock ring, and strainer
- OEM #: D0WY-9275-A

**110667** 1 Pc. / Box



### Door Latch Striker Plates for 1967-72 Chevy & GMC Truck

- Excellent reproduction of the original design
- Zinc plated, sold in pair

**110223** 1 Pair / Box

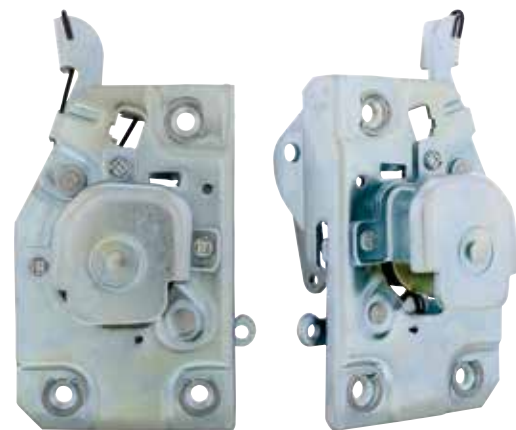

### Truck Door Latch for 1967-72 Chevy & GMC

- Precision stampings with original design mechanism
- Zinc plated. LH & RH sold individually
- Fits pickup and suburban
- Mounting hardware not included

**110262** R/H - 1 Pc. / Bulk

**110263** L/H - 1 Pc. / Bulk



### Battery Hold-Down Frame for 1947-55 Chevy & GMC Truck

- Excellent reproduction of the original design
- Die-stamped steel black painted

**110470** 1 Pc. / Box



### Battery Hold-Down Bracket for 1958-66 Chevy & GMC Truck

- 304 High grade stainless steel

**110473** 1 Pc. / Box



### 3 LED Dual Function Mini Auxiliary/Utility Light w/ Bezel

- 3 LED mini dual function clearance marker light with stainless steel bezel
- Requires 3/4" diameter hole for installation
- Fits panels and bumpers up to 1/4" thick. Includes plastic backing washer when mounting on thin body panels

**36600** Amber LED /Amber Lens - 1 Pc. / Card

**36601** Red LED /Red Lens - 1 Pc. / Card

**36602** Amber LED /Clear Lens - 1 Pc. / Card

**36603** Red LED /Clear Lens - 1 Pc. / Card



### LED Flasher w/Reverse Polarity Base & Extension Wires

- 12 Volt, 20 amp maximum
- Solves turn signal problems, such as hyper flashing, no flashing, or burnt out bulb indication when using led lights and bulbs
- Includes polarity reversing base & extension wires

**90649** 1 Set / Card



### Multi-Color High Power LED Rock Light

- Multi-color high power LEDs for easy navigation when rock crawling
- Plays millions of colors of light with music from smart phone
- Control & dim lights with rgb remote app.
- Cree LEDs in a waterproof and aluminum housing
- Mounting pads & spacers, screws and instructions included
- Supports most iPhone, iPad and Android smartphones

**36604** 1 Kit / Color Box





### Chrome Spike Nut Cover for 1999 - 2004 Ford F-Series

- Fits 1999-2004 Ford F-Series truck models with original steel wheel hubcap
- Spike accessory is sized to fit the push-on simulated lug nut on OE steel wheel hubcap
- Spike is quality molded plastic with beautiful long lasting chrome plating

**10718B** 1 Pc. / BULK



### Chrome 3 Skull Shift Knob

- Ultra high quality chrome finish
- Universal hex screw mount design, includes mounting hardware, adapters, & hex ranch

**70708** 1 Pc. / Card



### United Pacific '32 Truck T-Shirt

- Gray color

<b>99104M</b>	Medium - 1 Pc. / Bulk
<b>99104L</b>	Large - 1 Pc. / Bulk
<b>99104XL</b>	X-Large - 1 Pc. / Bulk
<b>99104XXL</b>	XX-Large - 1 Pc. / Bulk

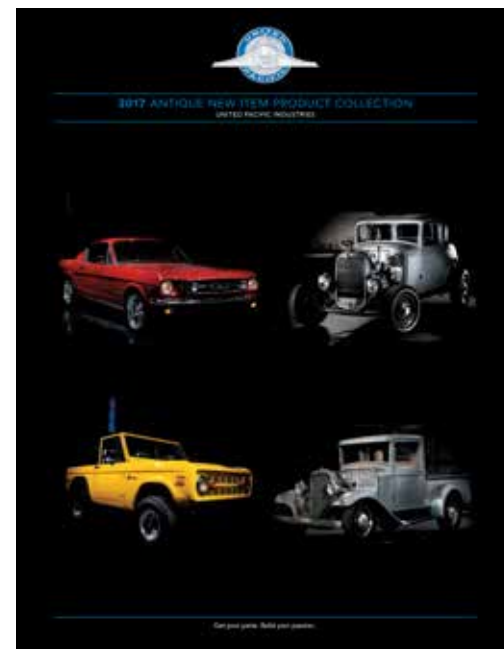

### 2017 New Item Product Collection Catalog Item # ANF1217

**Available Now!**

# NEW ITEMS

May 2018



### 44 LED Tail Light Insert Board for 1951 Ford Passenger Car

- Super bright LED circuit board installs behind existing lens
- Dual function with tail light & bright stop/turn signal
- For use on 12 volt vehicles only (not 6 volt)
- Easy electrical connection with 1157 plug, no modification to vehicle
- Recommended upgrade under dash flasher to 90652 led flasher
- Not for use with blue dots

<b>110128</b>	LED Tail Light Insert Board - 1 Pc. / Card
<b>F5103</b>	Lens Gasket - 1 Pair / Bulk
<b>F5101</b>	Tail Light Lens - 1 Pc. / Card



### Load Resistor Kit, Solves LED Issue, 50 Watt/6 OHM

- For LED turn signal lights or led license plate lights
- Eliminate LED turn signal problems, such as hyper flashing, no flashing, or burnt out bulb indication
- Simulates the load of an incandescent bulb to solve most LED issues
- Aluminum housing with proprietary heat management allows installation in most locations
- Kit includes two load resistors and 4 connectors

**34235** 2 Pcs. / Color Box



## Mirror Bundles



### 3" Peep Mirror

- Convex peep mirror with wide angle optics for R/H side
- Polished stainless steel mirror head & chrome plated arm
- Includes mounting pad and hex wrench for installation
- Bundle includes: C5001-1 & C5001-1CVX Pre-packed in one box for shipping

110741 1 Pair / Box



### 4" Peep Mirror

- Convex Peep Mirror with Wide Angle Optics for R/H Side
- Polished Stainless Steel Mirror Head & Chrome Plated Arm
- Includes Mounting Pad and Hex Wrench for Installation
- Bundle includes: C5001 & C5001-CVX Pre-Packed in One Box for Shipping

110742 1 Pair / Box



### 4" Peep Mirror with LED Turn Signal

- Convex peep mirror with wide angle optics for R/H side
- Red 7 LED arrow hidden inside mirror glass, 12 volt
- Polished stainless steel mirror head & chrome plated arm
- Includes mounting pad and hex wrench for installation
- Bundle includes: C5001-LED & C5001-CVXLED pre-packed in one box for shipping

110743 1 Pair / Box



### Exterior Mirror for 1955-57 Chevy Passenger Car

- Convex Peep Mirror with Wide Angle Optics for R/H Side
- Polished Stainless Steel Mirror Head & Chrome Plated Arm
- Includes Mounting Pad and Hex Wrench for Installation
- Bundle Includes: C555728 & C555728-CVX Pre-Packed in One Box for Shipping

110745 1 Pair / Box



### Exterior Mirror with LED Turn Signal for 1955-57 Chevy Passenger Car

- Convex peep mirror with wide angle optics for R/H side
- Red 7 led arrow hidden inside mirror glass
- Polished stainless steel mirror head & chrome plated arm
- Includes mounting pad and hex wrench for installation
- Bundle includes: C555728-LED & C555728-LEDCVX pre-packed in one box for shipping

110746 1 Pair / Box



### Exterior Mirror with Bowtie Logo for 1965-66 Chevy Passenger Car

- Convex Peep Mirror with Wide Angle Optics for R/H Side
- Full Size Mirror Housing with Chevy Bowtie Logo
- Polished Stainless Steel Mirror Head & Chrome Plated Arm
- Includes Mounting Pad and Hex Wrench for Installation
- GM Restoration Licensed Product
- Bundle Includes: C656601 & C656602 Pre-Packed in One Box for Shipping

110747 1 Pair / Box

## LED Tail Light Bundle



### 23 LED Tail Light with LED Blue Dot for 1940-53 Chevy & GMC Truck & 1937-38 Chevy Passenger Car

- Dual function with tail light and bright stop/turn signal
- Blue dot can be controlled independently with additional wiring
- Lefthand includes 6 super white LEDs for license plate light
- Complete with polycarbonate lens
- Epoxy coated, fully sealed electronics
- Solid state circuit boards are designed for 7.7-14.0 VDC
- Bundle includes: CTL4053LED-LBD & CTL4053LED-RBD pre-packed in one box for shipping

110750 1 Pair / Box

## NEW ITEMS

June 2018

# MUSTANG 1964 1/2 to 1970



110629



110630

### Complete Door Glass Assembly for 1967-68 Ford Mustang Fastback

- Heavy 16 gauge stamped channel with riveted track rollers
- Polished stainless steel upper glass frame
- Available with crystal clear non-tinted tempered window glass or original style green tinted tempered window glass
- Fully assembled from factory for a quick and straight forward replacement
- Sold individually, please specify L/H or R/H

110628	R/H Clear - 1 Pc. / Box
110629	L/H Clear - 1 Pc. / Box
110630	R/H Tint - 1 Pc. / Box
110631	L/H Tint - 1 Pc. / Box



110621



110622

### Complete Door Glass Assembly for 1967-68 Ford Mustang Coupe

- Heavy 16 gauge stamped channel with riveted track rollers
- Polished stainless steel upper glass frame
- Available with crystal clear non-tinted tempered window glass or original style green tinted tempered window glass
- Fully assembled from factory for a quick and straight forward replacement
- Sold individually, please specify L/H or R/H

110620	R/H Clear - 1 Pc. / Box
110621	L/H Clear - 1 Pc. / Box
110622	R/H Tint - 1 Pc. / Box <i>Coming Soon</i>
110623	L/H Tint - 1 Pc. / Box



110625

110626

### Complete Door Glass Assembly for 1967-68 Ford Mustang Convertible

- Heavy 16 gauge stamped channel with riveted track rollers
- Polished stainless steel upper glass frame
- Available with crystal clear non-tinted tempered window glass or original style green tinted tempered window glass
- Fully assembled from factory for a quick and straight forward replacement
- Sold individually, please specify L/H or R/H

110624	R/H Clear - 1 Pc. / Box	
110625	L/H Clear - 1 Pc. / Box	
110626	R/H Tint - 1 Pc. / Box	Coming Soon
110627	L/H Tint - 1 Pc. / Box	Coming Soon

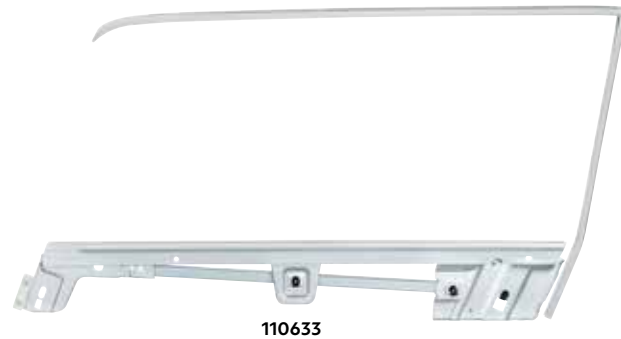

110633



110635

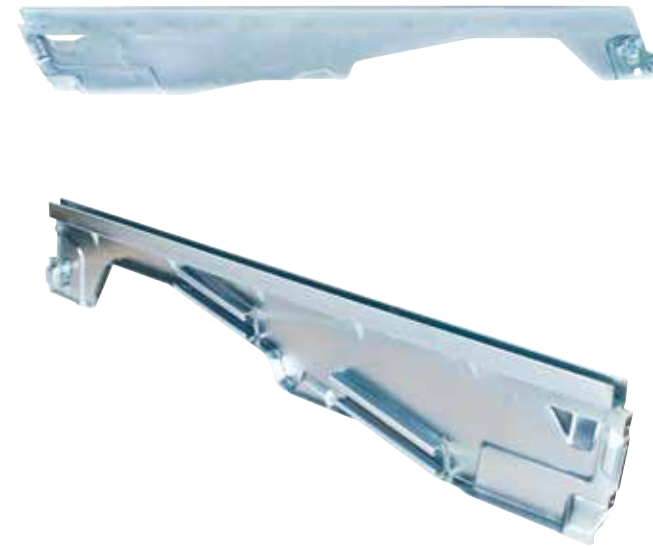

### Door Glass Channel for 1964.5-66 Ford Mustang

- High quality 20 gauge steel
- Accurate reproduction with all original contour detail and cutouts
- Sold individually, please specify L/H or R/H

110618	R/H - 1 Pc. / Box
110619	L/H - 1 Pc. / Box



### Complete Door Glass Assembly for 1969-70 Ford Mustang Coupe & Convertible

- Heavy 16 gauge stamped channel with riveted track rollers
- Crystal clear non-tinted glass cut to original shape
- Fully assembled from factory for a quick and straight forward replacement
- Sold individually, please specify L/H or R/H

110640	R/H - 1 Pc. / Box	Coming Soon
110641	L/H - 1 Pc. / Box	



### Quarter Window Assembly with Clear Glass for 1967-68 Ford Mustang Coupe

- Heavy 16 gauge stamped steel window track with mounting hardware
- Crystal clear non-tinted glass tempered glass
- Beautifully polished stainless steel window frame with weatherstrip
- Fully assembled from factory for a quick and straight forward replacement
- Sold individually, please specify L/H or R/H

110644	R/H - 1 Pc. / Box
110645	L/H - 1 Pc. / Box

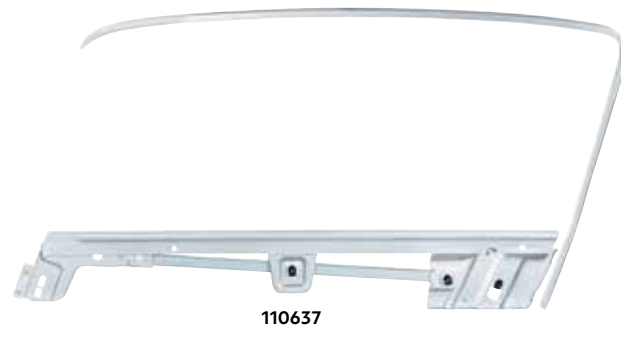

110637

### Door Glass Frame Kit for 1967-68 Ford Mustang

- Heavy 16 gauge stamped channel with riveted track rollers
- Polished stainless steel upper glass frame
- Sold individually, please specify L/H or R/H

110632	R/H Coupe - 1 Pc. / Box
110633	L/H Coupe - 1 Pc. / Box
110634	R/H Convertible - 1 Pc. / Box
110635	L/H Convertible - 1 Pc. / Box
110636	R/H Fastback - 1 Pc. / Box
110637	L/H Fastback - 1 Pc. / Box

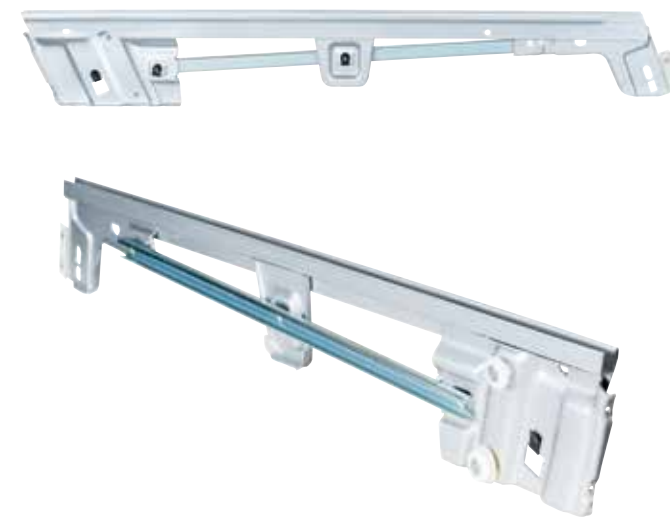

### Door Glass Channel for 1967-68 Ford Mustang Coupe, Convertible, & Fastback

- Heavy 16 gauge stamped channel with riveted track rollers
- Sold individually, please specify L/H or R/H

110638	R/H - 1 Pc. / Box
110639	L/H - 1 Pc. / Box



110488



110489

### Rear Valance for 1964.5-66 Ford Mustang

- High quality 19 gauge sheet metal
- Black EDP coated
- Includes license plate mounting bracket with mounting holes
- Available with backup light cutouts only or backup & dual exhaust cutouts for Mustang GT

110488	Backup Light Cutouts - 1 Pc. / Box
110489	Backup Light & Exhaust Cutouts - 1 Pc. / Box



#### A-Pillar Hinge Jamb Post for 1966-67 Ford Bronco

- Exact duplicate of the factory OEM door pillar
- Has heavy duty hinge backing plates with 5/16-18 thread exactly like the original design
- Coated in weldable primer
- OEM #: C6TZ-9602501-A/C6TZ-9602500-A
- Sold individually, please specify L/H or R/H

<b>110233</b>	L/H - 1 Pc. / Box
<b>110234</b>	R/H - 1 Pc. / Box



#### A-Pillar Hinge Jamb Post for 1968-77 Ford Bronco

- Excellent quality 17 gauge sheet metal coated with weldable primer
- Three 5/16-18 square nuts installed for easy fender mounting
- Features two caged door hinge mounting plates with 5/16-18 threaded holes
- Original style steel fender liner panel included
- Sold individually, please specify L/H or R/H

<b>110509</b>	R/H - 1 Pc. / Box
<b>110510</b>	L/H - 1 Pc. / Box



#### Bumper Bolt Set for 1966-77 Ford Bronco & 1964.5-70 Ford Mustang

- Highly polished 1" long 7/16-14 carriage bolt to match that beautifully polished front and rear bumper
- Includes spring wave washers and serrated 7/16-14 flange locknuts
- Two extra 5/16-18 polished carriage bolts and nuts for the Mustang front bumper

<b>110536</b>	1 Set / Card
---------------	--------------



#### Door Striker Mounting Nut Plate Kit for 1932 Ford Closed Car

- High quality 20 gauge retainer bracket
- 12-24 D-nuts installed on a 19 gauge bracket
- Each kit comes with 2 retainers and 2 d-nut brackets
- All parts are coated in black EDP

<b>B20123-1</b>	1 Set / Bulk
-----------------	--------------



110512 110511

#### B-Pillar Reinforcement for 1966-77 Ford Bronco

- Stamped heavy 16 gauge sheet metal
- Coated in weldable primer
- Sold individually, please specify L/H or R/H

<b>110511</b>	L/H - 1 Pc. / Bulk
<b>110512</b>	R/H - 1 Pc. / Bulk



#### Front Floor Pan Assembly for 1968-77 Ford Bronco

- Fully assembled with spot welds to ensure proper structural integrity
- Each heavy duty steel panel is die stamped with all original contour and mounting detail
- Has all of the original cutouts such as fuel tank selector switch
- Coated in weldable primer

<b>110504</b>	1 Pc. / Box
---------------	-------------



Upper Hinge Has Original 12-24 Mirror Thread

#### Door Hinge Set for 1932-34 Ford Truck

- All mounting holes and threads fully machined & ready to install
- Precision cast stainless steel for strength & durability
- Includes stainless hinge pins and steel black oxide 5/16-24 hinge screws & washers
- One set required per door, fits L/H & R/H

<b>B21010</b>	Fits L/H & R/H - 1 Set / Box
---------------	------------------------------



#### Door Hinge Set for 1932 Closed Car (Exc. 3W)

- Fits front doors of 5 Window Coupe, Tudor, Fordor, Sport Coupe, B400 and Victoria
- All mounting holes and threads fully machined & ready to install
- Precision cast stainless steel for strength and durability
- Includes special threaded backing plates to mount hinge on door side
- Includes stainless hinge pins and steel black oxide 5/16-24 hinge screws & washers
- One set required per door, does not fit 3-Window Coupe

<b>B20010</b>	R/H - 1 Set / Box
<b>B20011</b>	L/H - 1 Set / Box



### Stainless 3" x 10" Radiator Overflow Tank

- Show quality polished stainless steel tank
- Polished aluminum filler cap with o-ring seal
- Holds 2 1/4 pints
- Includes stainless mounting brackets, hardware, and instructions
- Universal application fits most classic cars, trucks and hot rods

**A6132** 1 Pc. / Color Box



**2,400 LUMENS** **5w X 9** HIGH POWER **12v-24v** MULTIPLE VOLTAGE

### 9 High Power LED Driving/Work Light with Side LED - Spot/Flood Light

- 6 LEDs at front - spot light and 3 LEDs at side - flood light
- Stainless steel mounting bracket and hardware
- Operates on 12V-24V, draws 2.8 Amps at 12V
- **3 years warranty**

**36509** 1 Pair / Color Box



### Exterior Mirror for 1970-72 Chevy & GMC Truck

- Polished stainless steel mirror head & chrome plated arm
- Includes mounting pad, mounting bracket and screws
- Bundle includes: C707201 & C707202 pre-packed in one box for shipping

**110748** 1 Pair / Box



### Exterior Mirror with LED Turn Signal for 1970-72 Chevy & GMC Truck

- Red 9 LED arrow hidden inside mirror glass (hidden when off)
- Polished stainless steel mirror head and chrome plated arm
- Includes mounting pad, mounting bracket and screws
- Easy hookup, just route wire through door jamb and connect to front turn signal wires under dash near steering column
- Correct for 1970-72, but can be used to update 1967-69 trucks
- Bundle includes: C707201-LED & C707202-LED pre-packed in one box for shipping

**110749** 1 Pair / Box



### All American Series 6 Gauge Set

- 3 3/8" Speedo & Tach, 2 1/8" Fuel (240-33), oil, temp, & volts
- Stainless high step bezel with curved glass lens
- Available in black gauge face or nickel gauge face
- Includes all sending units except fuel sending unit

**110752** **Black Gauge Face - 1 Set / Box**

**110023** **Nickel Gauge Face - 1 Set / Box**

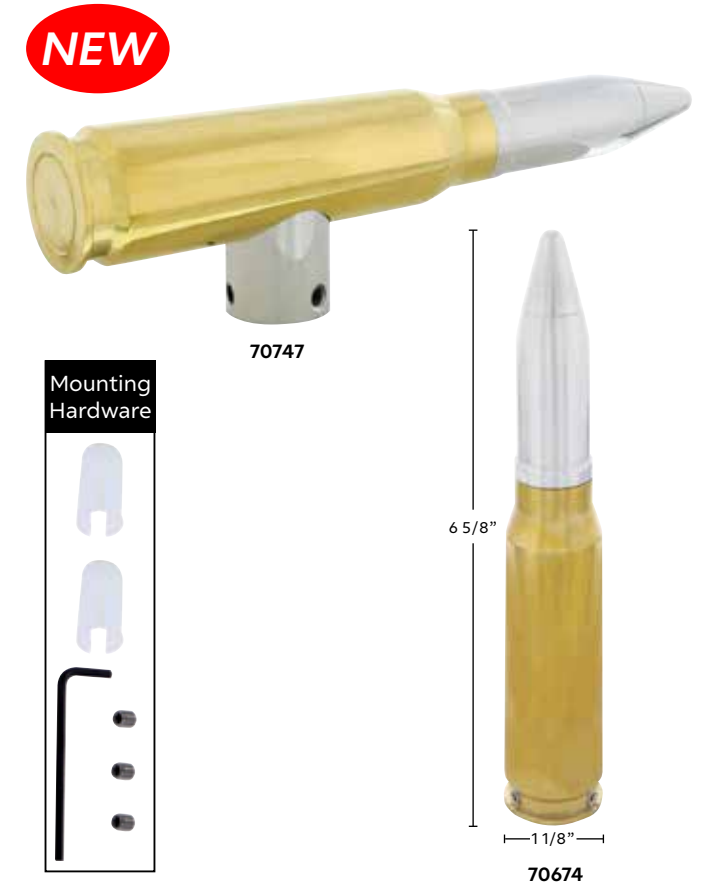

### 50 Caliber Bullet Shift Knob

- Ultra high quality finish
- Heavy duty solid brass construction ensures strength & durability
- Universal hex screw mount design, includes mounting hardware
- Available in t-handle or vertical design

**70747** **T-Handle - 1 Pc. / Card**

**70674** **Vertical - 1 Pc. / Card**



### Load Resistor Kit, Solves LED Issue, 50 Watt/6 OHM

- 50W 6Ohm LED load resistors for LED turn signal lights or LED license plate lights
- Eliminate LED turn signal problems, such as hyper flashing, no flashing, or burnt out bulb indication
- Simulates the load of an incandescent bulb to solve most led issues
- Aluminum housing with proprietary heat management allows installation in most locations
- Kit includes two load resistors and 4 connectors

**34235** 2 Pcs. / Color Box

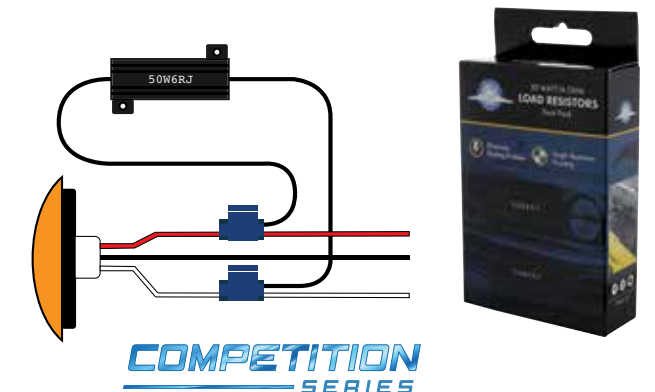

# NEW ITEMS

July 2018



Original Style Stainless Steel Grille Insert for 1932 Ford Passenger Car

- Die stamped 304 polished stainless steel
- Desirable version with the separate outer surround trim
- Available with crank hole or without crank hole

**B20340** with Crank Hole - 1 Pc. / Box

**B20341** without Crank Hole - 1 Pc. / Box

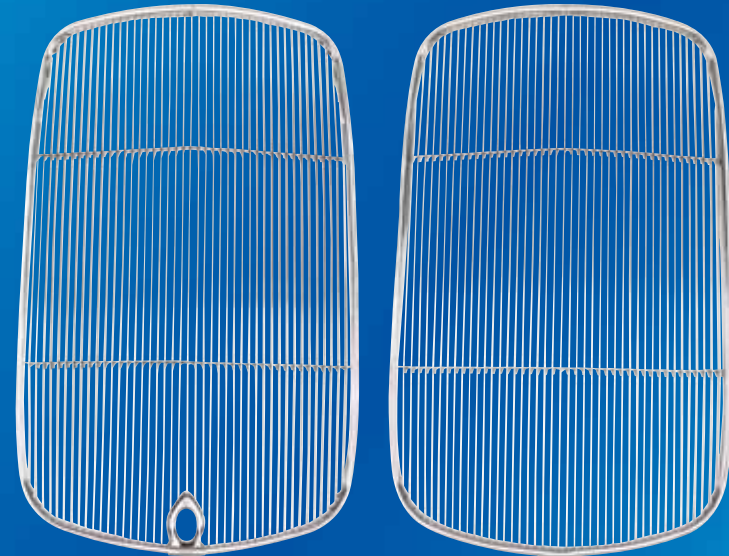

B20340

B20341



Original Style Steel Splash Apron For 1932 Ford Passenger Car & Truck

- Excellent quality 19 gauge sheet metal
- Die stamped with original contour detail
- Including all mounting holes and 1/4-20 d-nuts installed exactly like the original design
- Black EDP coated
- OEM #: B-16527

**B20322** 1 Pc. / Box



Interior Sun Visor Assembly for 1932 Ford Closed Car

- Deluxe version with polished stainless steel adjustable bracket
- Includes ready-to-use black textured fiberboard visor with original edge detail
- Uses removable hardware for easy disassembly if you choose to upholster
- Sold each

**B20151** 1 Pc. / Box



Battery Hold-Down Frame for 1955-57 Chevy & GMC Truck

- Excellent reproduction of the original design
- Fits group-24 battery size
- Die-stamped steel black painted

**110471** 1 Pc. / Bulk



Battery Hold-Down Frame for 1947-55 Chevy & GMC Truck

- Excellent reproduction of the original design
- Die-stamped steel black painted

**110470** 1 Pc. / Box



Battery Hold-Down Bracket for 1958-66 Chevy & GMC Truck

- Anti-corrosive vinyl plastisol coating

**110472** 1 Pc. / Bulk



Battery Hold-Down Bracket for 1958-66 Chevy & GMC Truck

- 304 High grade stainless steel

**110473** 1 Pc. / Box







### Chrome Headlamp Bezel Set for 1955-57 Chevy Truck

- Includes seals
- Sold in set

**110705** 1 Set / Box



### Fuel Sending Unit for 1973-75 Chevy & GMC Truck

- Made with corrosion resistant stainless steel
- RH tank, 1 outlet
- Brass float just like the original
- Includes rubber seal, stainless steel lock ring, and strainer
- OEM #: 6429439

**110676** 1 Pc. / Box



### Fuel Sending Unit for 1980-89 Chevy & GMC Truck

- Made with corrosion resistant stainless steel
- LH tank, 3 outlets
- Brass float just like the original
- Includes rubber seal, stainless steel lock ring, and strainer
- OEM #: 25002010

**110675** 1 Pc. / Box



### Fuel Sending Unit for 1980-89 Chevy & GMC Truck

- Made with corrosion resistant stainless steel
- RH tank, 3 outlets
- Brass float just like the original
- Includes rubber seal, stainless steel lock ring, and strainer
- OEM #: 25002007

**110671** 1 Pc. / Box



### Fuel Sending Unit for 1973-79 Chevy & GMC Truck

- Made with corrosion resistant stainless steel
- LH tank, 2 outlets
- Brass float just like the original
- Includes rubber seal, stainless steel lock ring, and strainer
- OEM #: 25000612

**110674** 1 Pc. / Box



### Fuel Sending Unit for 1973-79 Chevy & GMC Truck

- Made with corrosion resistant stainless steel
- RH tank, 2 outlets
- Brass float just like the original
- Includes rubber seal, stainless steel lock ring, and strainer
- OEM #: 25000610

**110670** 1 Pc. / Box



### Fuel Sending Unit for 1980-84 Chevy & GMC Truck

- Made with corrosion resistant stainless steel
- LH tank, 2 outlets
- Brass float just like the original
- Includes rubber seal, stainless steel lock ring, and strainer
- OEM #: 25002009

**110673** 1 Pc. / Box



### Fuel Sending Unit for 1973-79 Chevy & GMC Truck - 6 cyl

- Made with corrosion resistant stainless steel
- RH tank, 3 outlets
- Brass float just like the original
- Includes rubber seal, stainless steel lock ring, and strainer
- OEM #: 25000611

**110672** 1 Pc. / Box



### Headlamp Bracket for 2007-2016 Jeep Wrangler

- Sold individually, please specify L/H or R/H side
- OEM #: 55078149AC

<b>110585</b>	L/H - 1 Pc. / Box
<b>110586</b>	R/H - 1 Pc. / Box



### Chrome Art-Deco Nude Lady Grab Handle

- Unique avant-garde design
- Quality die cast & beautifully chrome plated
- Traditionally used for classic big rig trucks
- Also perfect for doors, cabinets, knobs, mancave, garage
- Mounting hole center to center distance is 11-1/2"
- Includes stainless mounting screws, lock nuts and hex wrench for trucks
- Mounting screws for doors & cabinets not included

<b>C5036-3</b>	1 Pc. / Box
----------------	-------------

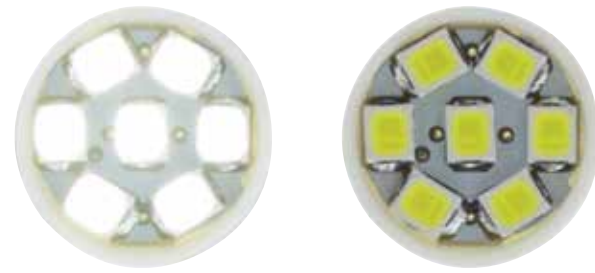

### 7 White LED 912/921 Bulb

- 912/921 Bulb with 7 micros LEDs
- 912/921 Wedge base, also fits 194 socket

<b>36504</b>	2 Pcs. / Card
--------------	---------------

**34**  
LUMENS



### High Power LED 4" x 6" Rectangular Headlight

- Available with 9-white led daytime running light or 9-amber LED auxiliary light
- Waterproof die cast housing and polycarbonate lens provide maximum protection and durability
- OEM fit, plug into existing wiring harness
- Sold each, please specify low beam or high beam

<b>31150</b>	<b>Low Beam with Amber Auxiliary Light</b> - 1 Pc. / Color Box
<b>31151</b>	<b>High Beam with Amber Auxiliary Light</b> - 1 Pc. / Color Box
<b>31152</b>	<b>Low Beam with Daytime Running Light</b> - 1 Pc. / Color Box
<b>31153</b>	<b>High Beam with Daytime Running Light</b> - 1 Pc. / Color Box



### 5 3/4" Motorcycle Headlight - Bottom Mount

- Headlight housing available separately: Item #32051 (Chrome) / #32052 (Black)

Item #	Bottom Mount Motorcycle Headlight		
	Housing	Bulb	Bulb Type
<b>32787</b>	32051 (Chrome)	S2005LED	Crystal Headlight w/Amber LED Auxiliary/Utility Light
<b>32788</b>	32052 (Black)	S2005LED	Crystal Headlight w/Amber LED Auxiliary/Utility Light
<b>32791</b>	32051 (Chrome)	31386	Crystal Headlight
<b>32792</b>	32052 (Black)	31386	Crystal Headlight
<b>32795</b>	32051 (Chrome)	31259	9 LED Headlight w/Amber LED Position Light Bar
<b>32796</b>	32052 (Black)	31259	9 LED Headlight w/Amber LED Position Light Bar
<b>32799</b>	32051 (Chrome)	31267	9 LED Headlight w/White LED Position Light Bar
<b>32800</b>	32052 (Black)	31267	9 LED Headlight w/White LED Position Light Bar
<b>32803</b>	32051 (Chrome)	31201	8 High Power LED Silver Headlight
<b>32804</b>	32052 (Black)	31201	8 High Power LED Silver Headlight
<b>32807</b>	32051 (Chrome)	31202	8 High Power LED Black Headlight
<b>32808</b>	32052 (Black)	31202	8 High Power LED Black Headlight



### 5 3/4" Motorcycle Headlight - Side Mount

- Headlight housing available separately: Item #32051 (Chrome) / #32052 (Black)

Item #	Side Mount Motorcycle Headlight		
	Housing	Bulb	Bulb Type
<b>32789</b>	32051 (Chrome)	S2005LED	Crystal Headlight w/Amber LED Auxiliary/Utility Light
<b>32790</b>	32052 (Black)	S2005LED	Crystal Headlight w/Amber LED Auxiliary/Utility Light
<b>32793</b>	32051 (Chrome)	31386	Crystal Headlight
<b>32794</b>	32052 (Black)	31386	Crystal Headlight
<b>32797</b>	32051 (Chrome)	31259	9 LED Headlight w/Amber LED Position Light Bar
<b>32798</b>	32052 (Black)	31259	9 LED Headlight w/Amber LED Position Light Bar
<b>32801</b>	32051 (Chrome)	31267	9 LED Headlight w/White LED Position Light Bar
<b>32802</b>	32052 (Black)	31267	9 LED Headlight w/White LED Position Light Bar
<b>32805</b>	32051 (Chrome)	31201	8 High Power LED Silver Headlight
<b>32806</b>	32052 (Black)	31201	8 High Power LED Silver Headlight
<b>32809</b>	32051 (Chrome)	31202	8 High Power LED Black Headlight
<b>32810</b>	32052 (Black)	31202	8 High Power LED Black Headlight

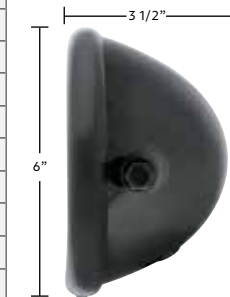

### Headlight Bulbs



# NEW ITEMS

July 2018



110583

110584



Includes Foam Gaskets & Mounting Hardware



### Billet Aluminum Tail Light Bezels for 1966-77 Ford Bronco

- CNC milled out of single solid aluminum block
- Durable anodized for a tough off-road look
- Stainless steel extended length socket head screws included for use with original tail light lens mounting holes
- Includes foam gaskets to prevent scratches to the tail light panel
- Sold as set

**110583** Clear Anodized - 1 Set / Color Box  
**110584** Satin Black Anodized - 1 Set / Color Box

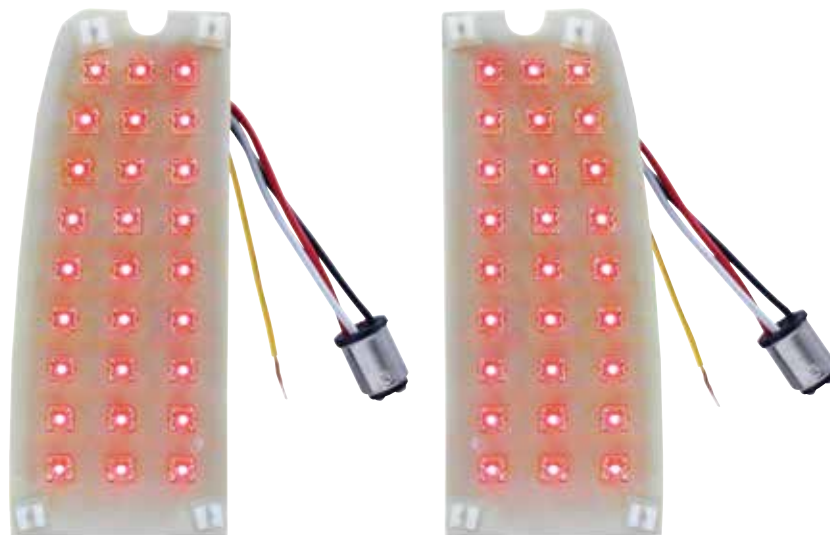

### 27 LED Sequential Tail Light Retrofit for 1967-77 Ford Bronco & 1967-72 Ford Truck

- Super bright LED circuit board installs behind existing lens
- Dual function with tail light & bright stop/turn signal
- Features sequential operation with selector switch to select sequential function ON/OFF
- Features sequential once brake attention function
- Easy electrical connection with 1157 plug, no modification to vehicle
- Requires united pacific LED turn signal flasher, item # 90652



**SEQUENTIAL**  
F · L · A · S · H

**((( BRAKE ATTENTION )))**

**110497** 1 Pair / Card



110366

110367

### Front Inner Wheel Tub for 1966-77 Ford Bronco

- High quality 18 gauge stamped steel reproduction
- Features all original design and tough spot welded construction
- Popular 1973-75 design works best with most steering setups and aftermarket power brake setup
- Coated with weldable primer
- Sold individually, please specify L/H or R/H side

**110366** R/H - 1 Pc. / Box

**110367** L/H - 1 Pc. / Box



### Front Wheel Tub to Radiator Core Support & Body Mount Brace Set for 1966-77 Ford Bronco (3/Set)

- Heavy duty 14 gauge sheet metal.
- Wheel tub braces with radiator core supports with frame mounts spot welded exactly like the original design
- Features mounting holes for battery tray installation
- Coated with weldable primer

**110368** 3 Pcs. Set / Box



### Fuel Sending Unit for 1966-76 Ford Bronco

- Made with corrosion resistant stainless steel
- Brass float just like the original
- Includes rubber seal, stainless steel lock ring, and strainer

110664 1 Pc. / Box



### Battery Tray for 1966-77 Ford Bronco

- Excellent reproduction of the original design
- Die-stamped steel black painted

110557 1 Pc. / Bulk



### Battery Hold-Down Bracket for 1966-69 Ford Bronco & 1967-70 Ford Mustang

- Anti-corrosive vinyl plastisol coating

110522 1 Pc. / Bulk



### Auxiliary Fuel Tank Sending Unit for 1966-77 Ford Bronco

- Made with corrosion resistant stainless steel
- Brass float just like the original
- Includes rubber seal, stainless steel lock ring, and strainer

110665 1 Pc. / Box



### Battery Hold-Down "J" Bolt Set for 1966-77 Ford Bronco & 1967-70 Ford Mustang

- Anti-corrosive coating
- Zinc plated

110523 1 Pair / Bulk

# NEW ITEMS

July 2018



110601



110605



110602



110606

### Complete Door Glass Assembly for 1965-66 Ford Mustang Fastback

- Heavy 16 gauge steel channel with all of the original detail and mounting holes
- Highly polished stainless steel glass frame
- Available with crystal clear non-tinted tempered window glass or original style green tinted tempered window glass
- Factory assembled with high quality rubber seal
- Exactly like the original design for a straight forward replacement
- Sold individually, please specify L/H or R/H side

110600	R/H Clear - 1 Pc. / Box
110601	L/H Clear - 1 Pc. / Box
110602	R/H Tint - 1 Pc. / Box
110603	L/H Tint - 1 Pc. / Box

### Complete Door Glass Assembly for 1965-66 Ford Mustang Convertible

- Heavy 16 gauge steel channel with all of the original detail and mounting holes
- Highly polished stainless steel glass frame
- Available with crystal clear non-tinted tempered window glass or original style green tinted tempered window glass
- Factory assembled with high quality rubber seal
- Exactly like the original design for a straight forward replacement
- Sold individually, please specify L/H or R/H side

110604	R/H Clear - 1 Pc. / Box
110605	L/H Clear - 1 Pc. / Box
110606	R/H Tint - 1 Pc. / Box
110607	L/H Tint - 1 Pc. / Box



110610



10609

### Complete Door Glass Assembly for 1965-66 Ford Mustang Coupe

- Heavy 16 gauge steel channel with all of the original detail and mounting holes
- Highly polished stainless steel glass frame
- Available with crystal clear non-tinted tempered window glass or original style green tinted tempered window glass
- Factory assembled with high quality rubber seal
- Exactly like the original design for a straight forward replacement
- Sold individually, please specify L/H or R/H side

110608	R/H Clear - 1 Pc. / Box
110609	L/H Clear - 1 Pc. / Box
110610	R/H Tint - 1 Pc. / Box
110611	L/H Tint - 1 Pc. / Box



110622



110621

### Complete Door Glass Assembly for 1967-68 Ford Mustang Coupe

- Heavy 16 gauge stamped channel with riveted track rollers
- Polished stainless steel upper glass frame
- Available with crystal clear non-tinted tempered window glass or original style green tinted tempered window glass
- Fully assembled from factory for a quick and straight forward replacement
- Sold individually, please specify L/H or R/H side

110620	R/H Clear - 1 Pc. / Box
110621	L/H Clear - 1 Pc. / Box
110622	R/H Tint - 1 Pc. / Box
110623	L/H Tint - 1 Pc. / Box



110630



110629

### Complete Door Glass Assembly for 1967-68 Ford Mustang Fastback

- Heavy 16 gauge stamped channel with riveted track rollers
- Polished stainless steel upper glass frame
- Available with crystal clear non-tinted tempered window glass or original style green tinted tempered window glass
- Fully assembled from factory for a quick and straight forward replacement
- Sold individually, please specify L/H or R/H side

110628	R/H Clear - 1 Pc. / Box
110629	L/H Clear - 1 Pc. / Box
110630	R/H Tint - 1 Pc. / Box
110631	L/H Tint - 1 Pc. / Box



110626



110625

### Complete Door Glass Assembly for 1967-68 Ford Mustang Convertible

- Heavy 16 gauge stamped channel with riveted track rollers
- Polished stainless steel upper glass frame
- Available with crystal clear non-tinted tempered window glass or original style green tinted tempered window glass
- Fully assembled from factory for a quick and straight forward replacement
- Sold individually, please specify L/H or R/H side

110624	R/H Clear - 1 Pc. / Box
110625	L/H Clear - 1 Pc. / Box
110626	R/H Tint - 1 Pc. / Box <i>Coming Soon</i>
110627	L/H Tint - 1 Pc. / Box <i>Coming Soon</i>



110613



110637



110615



110635



110617



110633

#### Door Glass Frame & Channel Kit for 1965-66 Ford Mustang

- Beautiful chrome finish door glass frame
- Heavy duty gauge steel channel with all of the original detail and mounting holes
- TEK screws included for mounting the frame to channel
- Sold individually, please specify L/H or R/H side

110612	R/H Fastback - 1 Pc. / Box
110613	L/H Fastback - 1 Pc. / Box
110614	R/H Convertible - 1 Pc. / Box
110615	L/H Convertible - 1 Pc. / Box
110616	R/H Coupe - 1 Pc. / Box
110617	L/H Coupe - 1 Pc. / Box

#### Door Glass Frame & Channel Kit for 1967-68 Ford Mustang

- Heavy 16 gauge stamped channel with riveted track rollers
- Polished stainless steel upper glass frame
- Sold individually, please specify L/H or R/H side

110636	R/H Fastback - 1 Pc. / Box
110637	L/H Fastback - 1 Pc. / Box
110634	R/H Convertible - 1 Pc. / Box
110635	L/H Convertible - 1 Pc. / Box
110632	R/H Coupe - 1 Pc. / Box
110633	L/H Coupe - 1 Pc. / Box



#### Quarter Window Assembly with Clear Glass for 1967-68 Ford Mustang Coupe

- Heavy 16 gauge stamped steel window track with mounting hardware
- Crystal clear non-tinted glass tempered glass
- Beautifully polished stainless steel window frame with weatherstrip
- Fully assembled from factory for a quick and straight forward replacement
- Sold individually, please specify L/H or R/H side

110644	R/H - 1 Pc. / Box
110645	L/H - 1 Pc. / Box <i>Coming Soon</i>



110647



110646

#### Quarter Window Assembly with Clear Glass for 1969-70 Ford Mustang Fastback

- Quality crystal clear untinted tempered glass
- High quality chrome window glass frame with rubber seal
- Upper and lower pivot arm with mounting brackets included
- Show quality chrome plated handle with steel braided safety wire and mounting bracket
- Sold individually, please specify L/H or R/H side

110646	R/H - 1 Pc. / Box
110647	L/H - 1 Pc. / Box



110488



110489

#### Rear Valance for 1964.5-66 Ford Mustang

- High quality 19 gauge sheet metal
- Black EDP coated
- Includes license plate mounting bracket with mounting holes
- Available with backup light cutouts only or backup & dual exhaust cutouts for Mustang GT

110488	Backup Light Cutouts - 1 Pc. / Box
110489	Backup Light & Exhaust Cutouts - 1 Pc. / Box



110493



110490

#### Rear Valance for 1967-68 Ford Mustang

- High quality 19 gauge sheet metal
- Feature all of the original contour detail
- License plate bracket with mounting holes spot welded from factory
- Includes the mounting tabs on the back of the Valance for easy installation
- Straight forward backup light installation with existing light cutout and mounting holes
- Black EDP coated
- Available with backup light cutouts only or backup & dual exhaust cutouts for Mustang GT

110493	Backup Light Cutouts - 1 Pc. / Box
110490	Backup Light & Exhaust Cutouts - 1 Pc. / Box



110494



110498

### Rear Valance for 1969-70 Ford Mustang

- High quality 19 gauge sheet metal
- Feature all of the original contour detail
- License plate bracket with mounting holes spot welded from factory
- Includes the mounting tabs on the back of the valance for easy installation
- Straight forward backup light installation with existing light cutout and mounting holes
- Black EDP coated
- Available with backup light cutouts only or backup & dual exhaust cutouts for Mustang GT

**110494** Backup Light Cutouts - 1 Pc. / Box

**110498** Backup Light & Exhaust Cutouts - 1 Pc. / Box



### 67 Shelby Style Tail Light Panel for 1967-68 Ford Mustang

- Quality 19 gauge sheet metal reproduction
- Feature the iconic 1967 Shelby GT style tail light cutout
- Includes cutout for the trunk lock cylinder and fuel filler neck
- Correctly timed fuel cap mounting holes to make sure the emblem is nice and straight
- Black EDP coated

**110653** 1 Pc. / Box

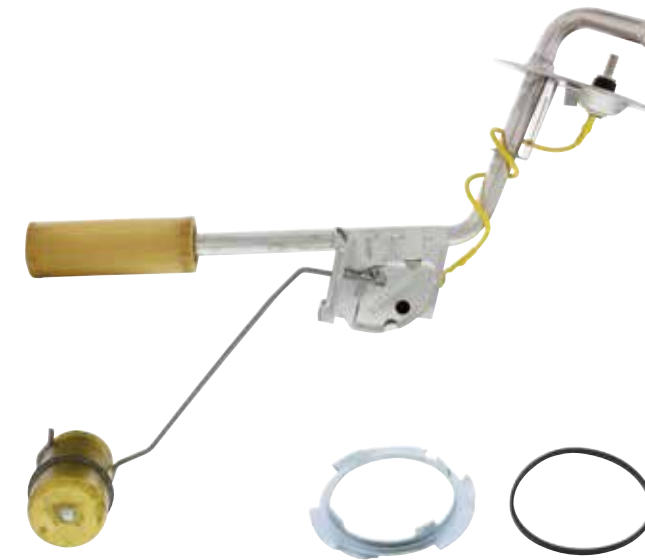

### Fuel Sending Unit for 1964-68 Ford Mustang

- Made with corrosion resistant stainless steel
- Brass float just like the original
- Includes rubber seal, stainless steel lock ring, and strainer

**110669** 1 Pc. / Box



### 16 GAL Fuel Tank with Drain Plug for 1964-68 Ford Mustang

- Made with corrosion resistant stainless steel sheet
- Die stamped with all original contour and mounting holes
- Machine welded to ensure proper seal
- Stainless steel drain plug pre-installed
- OEM #: C5ZZ-9002-D

**110678** 1 Pc. / Box

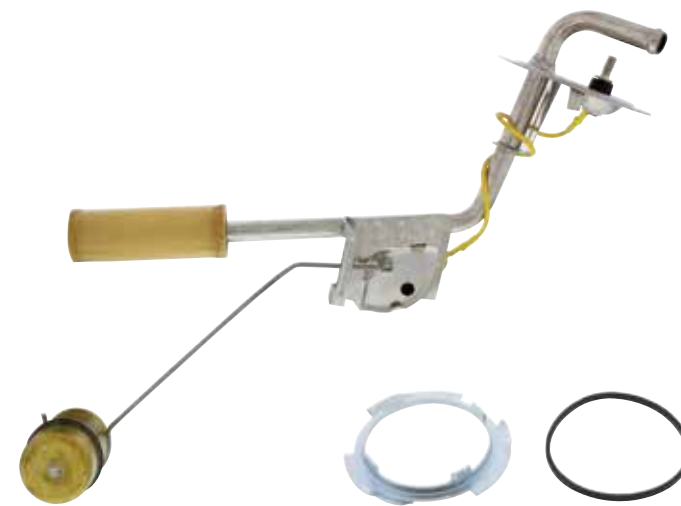

### Fuel Sending Unit for 1969 Ford Mustang

- Made with corrosion resistant stainless steel
- Brass float just like the original
- Includes rubber seal, stainless steel lock ring, and strainer

**110666** 1 Pc. / Box

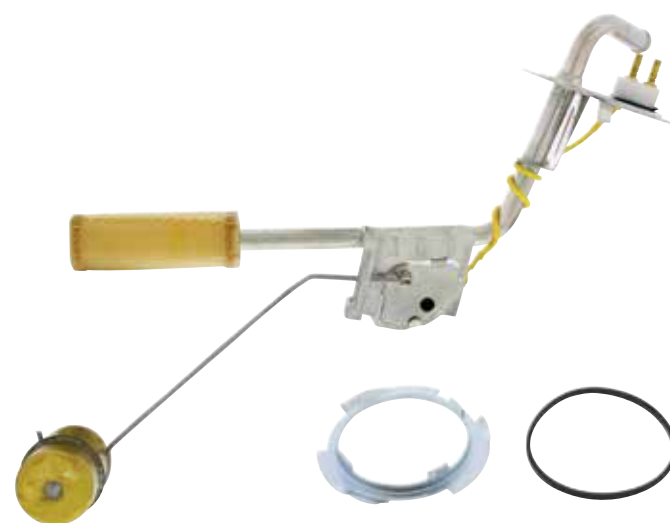

### Fuel Sending Unit for 1971-73 Ford Mustang

- Made with corrosion resistant stainless steel
- Brass float just like the original
- Includes rubber seal, stainless steel lock ring, and strainer

**110668** 1 Pc. / Box



### Chrome Interior Rear View Mirror Bracket for 1968-69 Ford Mustang

- Highly detailed die casting with chrome plating
- Includes mirror head mounting screw

**110710** 1 Pc. / Box



### Battery Hold-Down Bracket for 1966-69 Ford Bronco & 1967-70 Ford Mustang

- Anti-corrosive coating

**110522** 1 Pc. / Bulk



### Battery Hold-Down "J" Bolt Set for 1966-77 Ford Bronco & 1967-70 Ford Mustang

- Anti-corrosive coating

**110523** 1 Pair / Bulk

# NEW ITEMS

August 2018

## 1932-34 Ford Truck

### Cab Back for 1932-33 Ford Truck

- Exact replica of original die stamped cab back
- Fits 1934, does not have the 1934 large reveal on back
- Precision punched carriage bolt holes to OE specification for cab back wood mounting
- Black EDP coated
- Oversize freight policy

**B21051** 1 Pc. / Box



## Mustang Parts

### Chrome Front Bumper for 1967-68 Ford Mustang

- Made with heavy gauge sheet metal
- Features all original contour and detail
- Precision punched square mounting bolt holes for easy and quick installation
- Show ready chrome plating finish

**110484** 1 Pc. / Box



### Chrome Front Bumper for 1969-70 Ford Mustang

- Made with heavy gauge sheet metal
- Features all original contour and detail
- Precision punched square mounting bolt holes for easy and quick installation
- Show ready chrome plating finish

**110485** 1 Pc. / Box



### Hub Cap for 1968-69 Ford Mustang

- Highly polished stainless steel with black outer ring
- Also fits 1968-69 Ford Fairlane, Torino, and 1968-69 Mercury Montego, and Comet
- Sold each

**A6047** 1 Pc. / Box



### Hub Cap for 1968-69 Ford Mustang

- Highly polished stainless steel
- Red "GT" lettering with black outer ring
- Also fits 1968-69 Ford Fairlane, Torino, and 1968-69 Mercury Montego, and Comet
- Sold each

**A6046** 1 Pc. / Box

## Ford Parts

### Shoebox Gauge for 1949-50 Ford - Kilometers

- Direct fit into the stock dashboard using factory holes with the included mounting hardware

**110769** 1 Pc. / Box





## Universal Products



High power LED front spot light  
High power LED side flood light



NEW COLOR PACKAGING



### 19 High Power LED Work Light with Side LED

- 19 high power 1.5W LEDs with spot & flood function for exceptional performance
- Flip bracket mount fits both driver's & passenger's side
- Operates on 9V-30V, draws 1.75 Amps at 12V
- 3 year warranty

36505 1 Pc. / Color Box



NEW COLOR PACKAGING



### High Power LED Mini Work Light

- High power 10W Cree LED with spot function
- Operates on 9V-30V, draws 0.5 Amps at 12V
- 3 year warranty

36506 1 Pc. / Color Box



NEW COLOR PACKAGING

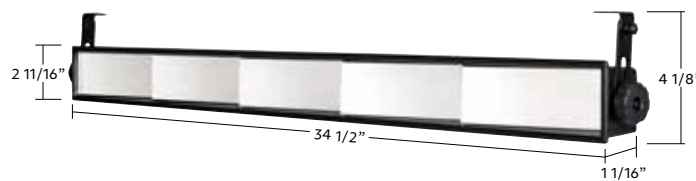

### Panoramic 5-Panel Rearview Mirror

- 5-panel mirror design provides wider rear view
- Easy installation in most cars, trucks & power sports vehicles
- Mounting hardware & instruction included
- May interfere with sun visors on some applications
- Recommended for performance & off-road vehicles

60051 1 Pc. / Color Box



### Black Day/Night Interior Rearview Mirror Assembly - Flat Type Mount

- Convenient day/night feature
- Available in 8" & 10"

60052 8" - 1 Pc. / Box

60053 10" - 1 Pc. / Box



### Spike Nut Cover for Chevy & GMC Full Size Pickup

- Fits many 2003-15 Chevrolet & GMC truck models with original steel wheel hubcap
- Spike nut cover is sized to fit the twist-on simulated lug nut on OE steel wheel hubcap
- Available in chrome and black
- Spike covers sold each. Hubcap not included

10349B Black - 1 Pc. / Bulk (New)

10351B Chrome - 1 Pc. / Bulk



### Steering Wheel Spinner

- Fits 1 1/8" to 1 5/8" diameter steering wheel grips
- Classic design intended to reduce effort and fatigue
- Not recommended for padded steering wheels

70092 1 Pc. / Card



### 50" x 60" Flannel Fleece Comfort Blanket

- Ultra soft and lightweight
- Wrinkle/fade/shrink resistant
- 100% microfiber polyester
- Machine washable

99113 Navy Blue - 1 Pc. / Card

99114 Scarlet Red - 1 Pc. / Card

99115 Ash Black - 1 Pc. / Card

99116 Olive Green - 1 Pc. / Card

## Motorcycle Parts



### Motorcycle Rubber Grip Set

- High quality molded rubber provides comfortable grip
- Old school dirt track look in 4 colors, sold in pairs
- Available for 7/8" or 1" handlebar, twist grip side has larger ID

52000 Black 1"/1-1/8" (25/28mm) - 1 Pair / Color Box

52001 Red 1"/1-1/8" (25/28mm) - 1 Pair / Color Box

52002 White 1"/1-1/8" (25/28mm) - 1 Pair / Color Box

52003 Natural 1"/1-1/8" (25/28mm) - 1 Pair / Color Box

52004 Black 7/8"/1" (22/25mm) - 1 Pair / Color Box

52005 Red 7/8"/1" (22/25mm) - 1 Pair / Color Box

52006 White 7/8"/1" (22/25mm) - 1 Pair / Color Box

52007 Natural 7/8"/1" (22/25mm) - 1 Pair / Color Box

# NEW ITEMS

August 2018



## Front Fender for 1966-77 Ford Bronco

- Die stamped with high quality sheet metal
- Features all original fender curvature and mounting pattern
- Black EDP coated
- Sold individually, please specify left or right hand side

**110463**

**L/H** - 1 Pc. / Box

**110464**

**R/H** - 1 Pc. / Box



## Black EDP Hood with W/S U-Bolt Holes, Washer Holes, & Vents for 1966-77 Ford Bronco

- Die stamped with high quality 18 gauge sheet metal
- Uses the early 66-69 style hood rod prop location
- Pre-drilled fold-down windshield u-bolt mounting holes with reinforcement center brace
- Also has air box vent openings and washer mounting holes
- Black EDP coated

**110460** 1 Pc. / Box



## Black EDP Hood with Vents for 1966-77 Ford Bronco

- Die stamped with high quality 18 gauge sheet metal
- Uses the early 66-69 style hood rod prop location
- Has air box vent openings
- Black EDP coated

**110461** 1 Pc. / Box



## Black EDP Hood with Washer Holes & Vents for 1966-77 Ford Bronco

- Die stamped with high quality 18 gauge sheet metal
- Uses the early 70-77 style hood rod prop location
- Has air box vent openings and washer mounting holes
- Black EDP coated

**110462** 1 Pc. / Box



**110465**



**110466**

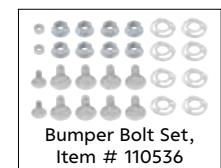

## Front/Rear Bumper for 1966-77 Ford Bronco

- Made with heavy gauge sheet metal
- Can be used as the front or the rear
- Features all original square shaped mounting holes
- Available in chrome and black finish

**110465**

**Chrome** - 1 Pc. / Box

**110466**

**Black** - 1 Pc. / Box



#### B-Pillar Door Jamb for 1966-67 Ford Bronco

- Excellent stamped 17 gauge sheet metal
- Features all original contour and detail
- Caged striker mounting plate with 5/16-18 tapped holes
- Includes upper pillar post extension
- Coated with weldable primer
- Sold individually, please specify LH or RH side

**110474** L/H - 1 Pc. / Box  
**110475** R/H - 1 Pc. / Box

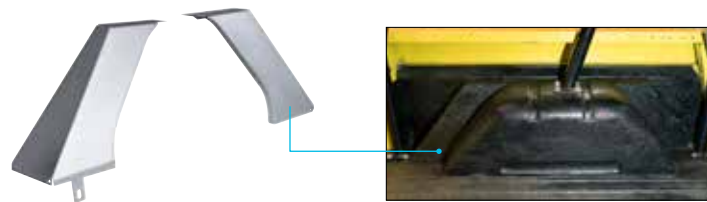

#### Tank Filler Guard Set for 1966-76 Ford Bronco

- Made with high quality sheet metal
- Has identical curvature and detail exactly like the original design
- Coated in weldable primer for easy attachment to wheel house and inner quarter panel
- A set includes the front and the back guard

**110331** 1 Pc. / Box



#### 1973-77 Style Dash Panel with Single DIN Radio Cutout for 1966-77 Ford Bronco

- Die stamped with quality 20 gauge sheet metal
- Features the later 73-77 original style contour and component cutouts
- Single DIN radio cutout for easy installation of modern head units
- Coated with weldable primer

**110502** 1 Pc. / Box



#### B-Pillar Door Jamb for 1968-77 Ford Bronco

- Excellent sheetmetal reproduction of the door b-Pillar jamb post with all of the original contour detail
- Die stamped with 18 gauge steel, coated in weldable primer
- Includes door latch striker plate, striker plate shims, striker plate screws & upper corner filler strip
- Sold individually, please specify LH or RH side
- OEM number: C8TZ-9628161-A

**110354** L/H - 1 Pc. / Box  
**110355** R/H - 1 Pc. / Box



#### Air Vent Box Gasket for 1966-77 Ford Bronco

- Made of highly durable black foam material
- Air vent box available separately, item #: 110239

**110095** 1 Pc. / Bulk

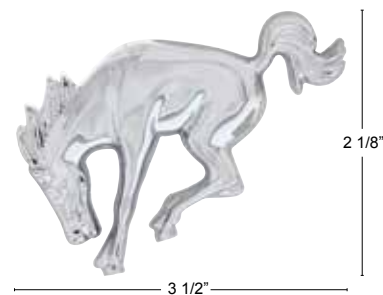

#### Chrome Bucking Bronco Emblem

- Easy installation
- Double sided tape included for easy installation

**50130** 1 Pc. / Card



# NEW ITEMS

August 2018

## Chevy Trucks Parts & Accessories



### Black EDP Front Bumper for 1947-55 Chevy & GMC Truck

- Die stamped with heavy gauge sheet metal
- Features identical curvature exactly like the original design
- Precision punched square carriage bolt holes for straight forward installation
- With black EDP coated finish

110729 1 Pc. / Box



### Black EDP Rear Bumper for 1947-53 Chevy & GMC Truck

- Die stamped with heavy gauge sheet metal
- Features identical curvature exactly like the original design
- Precision punched square carriage bolt holes for straight forward installation
- Black EDP coated

110730 1 Pc. / Box



### Black EDP Front Bumper for 1960-62 Chevy & GMC Truck

- Die stamped with heavy gauge sheet metal
- Features all the original contour and detail
- Precision punched square carriage Bolt holes for straight forward installation
- Pre-drilled license plate mounting holes
- Black EDP coated

110721 1 Pc. / Box



### Black EDP Front Bumper for 1963-66 Chevy & GMC Truck

- Die stamped with heavy gauge sheet metal
- Features all the original contour and detail
- Precision punched square carriage bolt holes for straight forward installation
- Pre-drilled license plate mounting holes
- Black EDP coated

110722 1 Pc. / Box



### Black EDP Rear Bumper for 1963-66 Chevy & GMC Truck

- Die stamped with heavy gauge sheet metal
- Features all the original contour and detail
- License plate recess and mounting bracket mounting holes
- Precision punched square carriage bolt holes for straight forward installation
- Black EDP coated

110725 1 Pc. / Box



### Black EDP Front Bumper for 1967-70 Chevy Truck & 1967-68 GMC Truck

- Die stamped with heavy gauge sheet metal
- Features all the original contour and detail
- Precision punched square carriage bolt holes for straight forward installation
- Pre-drilled license plate mounting holes
- Black EDP coated

110718 1 Pc. / Box



### Black EDP Rear Bumper for 1967-87 Chevy & GMC Fleetside Truck

- Die stamped with heavy gauge sheet metal
- Features all the original contour and detail
- License plate recess with mounting holes
- Precision punched square carriage bolt holes for straight forward installation
- Black EDP coated

110733 1 Pc. / Box



### Black EDP Front Bumper with Parking Light Recesses for 1967-72 GMC Truck

- Die stamped with heavy gauge sheet metal
- Features all the original contour and later style's parking light clearance recesses
- Precision punched square carriage bolt holes for straight forward installation
- Pre-drilled license plate mounting holes
- Black EDP coated

110719 1 Pc. / Box



### Black EDP Front Bumper for 1971-72 Chevy Truck

- Die stamped with heavy gauge sheet metal
- Features all the original contour and detail
- Parking light pockets with mounting flanges
- Precision punched square carriage bolt holes for straight forward installation
- Pre-drilled license plate mounting holes
- Black EDP coated

110720 1 Pc. / Box



### Chevy & GMC Tail Light Socket Wiring Boot with Rubber Conduit

- Identical design as the 1954-59 Chevy & GMC stepside truck's wiring
- Excellent universal tail light wiring boot for all hot rod & restoration projects
- Total length is 21-1/2"
- Sold each

C545504-2 1 Pc. / Bulk

# NEW ITEMS

September 2018

## Sequential Tail Light, Parts & Accessories for Ford, Chevy & GMC Truck



### Sequential Tail Light

DOT & SAE APPROVED

#### 38 Red LED Sequential Tail Light for 1953-56 Ford Truck

- Super bright red LED with fully sealed epoxy coated electronics
- Selector switch to control sequential function off, direction left, or direction right
- Also features a brake attention option with a sequential-once function
- 1157 double connector with offset pins, plugs into existing tail lamp socket
- Requires use of United Pacific LED turn signal flasher, item number: 90652 or 90649
- Sold individually, please specify left or right hand side

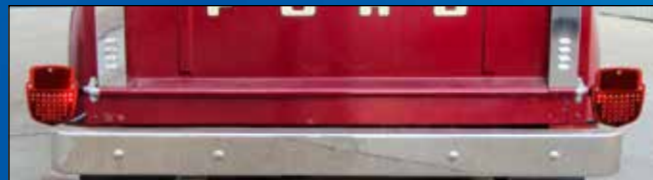

110144	L/H - 1 Pc. / Card
110145	R/H - 1 Pc. / Card



DOT & SAE APPROVED



#### 40 Red LED Sequential Tail Light for 1960-66 Chevy & GMC Fleetside Truck

- Super bright red LED with fully sealed epoxy coated electronics
- Selector switch to control sequential function off, direction left, or direction right
- Also features a brake attention option with a sequential-once function
- 1157 double connector with offset pins, plugs into existing tail lamp socket
- Requires use of United Pacific LED turn signal flasher, item number: 90652 or 90649

110199 1 Pc. / Card

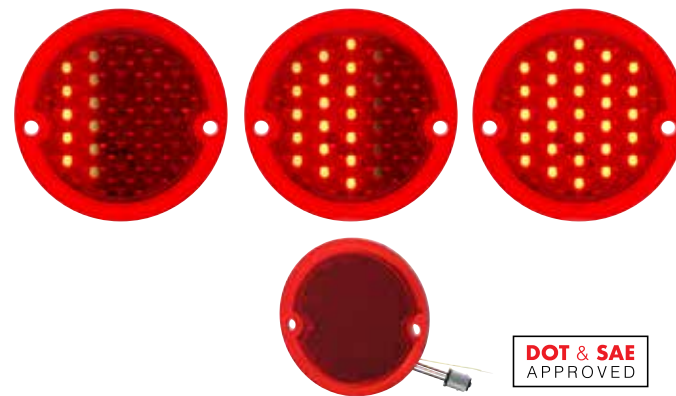

DOT & SAE APPROVED



#### 29 Red LED Sequential Tail Light for 1954-59 Chevy & GMC Truck

- Super bright red LED with fully sealed epoxy coated electronics
- Selector switch to control sequential function off, direction left, or direction right
- Also features a brake attention option with a sequential-once function
- 1157 double connector with offset pins, plugs into existing tail lamp socket
- Requires use of United Pacific LED turn signal flasher, item number: 90652 or 90649

110405 1 Pc. / Card

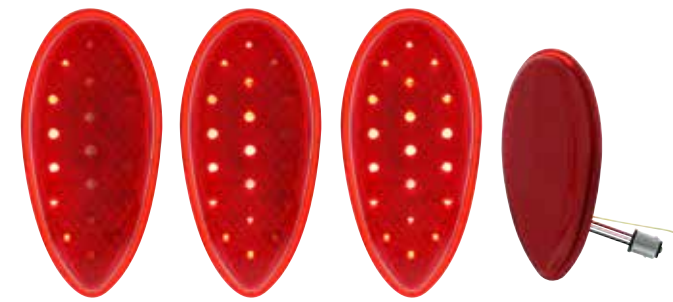

DOT & SAE APPROVED



#### 19 Red LED Sequential Tail Light for 1938-39 Ford Passenger Car

- Super bright red LED with fully sealed epoxy coated electronics
- Selector switch to control sequential function off, direction left, or direction right
- Also features a brake attention option with a sequential-once function
- 1157 double connector with offset pins, plugs into existing tail lamp socket
- Requires use of United Pacific LED turn signal flasher, item number: 90652 or 90649

110253 1 Pc. / Card



DOT & SAE APPROVED



#### 19 Red LED Sequential Tail Light Assembly for 1938-39 Ford Passenger Car

- Super bright red LED with fully sealed epoxy coated electronics
- Black powder coated housing, stainless steel rim
- Selector switch to control sequential function off, direction left, or direction right
- Also features a brake attention option with a sequential-once function
- 1157 double connector with offset pins, plugs into existing tail lamp socket
- Requires use of United Pacific LED turn signal flasher, item number: 90652 or 90649

110796 1 Pc. / Card

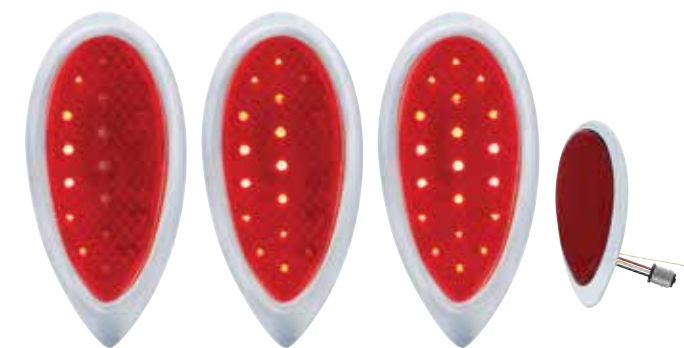

DOT & SAE APPROVED



#### 19 Red LED Sequential Tail Light with Chrome Flush Mount Bezel for 1938-39 Ford Passenger Car

- Super bright red LED with fully sealed epoxy coated electronics
- Chrome flush mount bezel
- Selector switch to control sequential function off, direction left, or direction right
- Also features a brake attention option with a sequential-once function
- 1157 double connector with offset pins, plugs into existing tail lamp socket
- Requires use of United Pacific LED turn signal flasher, item number: 90652 or 90649

110797 1 Pc. / Card

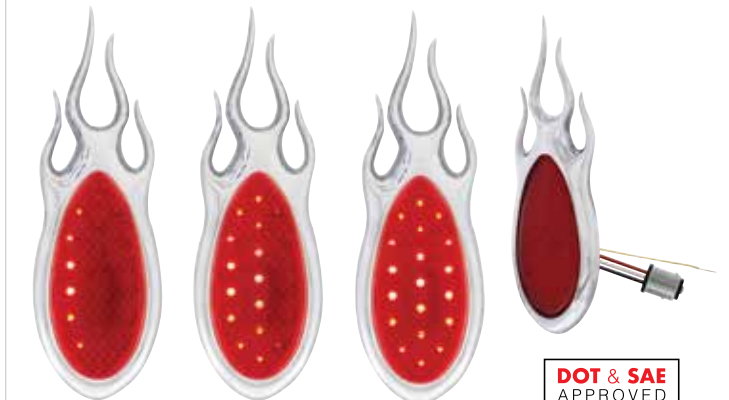

DOT & SAE APPROVED



#### 1938-39 Ford Car Style LED Sequential Tail Light with Chrome Flame Bezel

- Super bright red LED with fully sealed epoxy coated electronics
- Chrome plastic flame light bezel
- Selector switch to control sequential function off, direction left, or direction right
- Also features a brake attention option with a sequential-once function
- 1157 double connector with offset pins, plugs into existing tail lamp socket
- Can be use as auxiliary light or motorcycle tail light.
- Requires use of United Pacific LED turn signal flasher, item number: 90652 or 90649

110798 1 Pc. / Card

**1932-34 Ford Truck**



**B21004**



**B21005**



**Dash Panel for 1932-34 Ford Truck**

- Die stamped with high quality 18 gauge sheetmetal
- Features all of the original contour and mounting detail
- Precision punched center oval opening for original style dash tunnel
- Reinforced steering column mounting holes
- Black EDP coated
- Available with or without center hole

**B21004** With Center Hole - 1 Pc. / Box

**B21005** Without Center Hole - 1 Pc. / Box

**1932-34 Ford Car**



**Rear Fender for 1933-34 Ford Passenger Car**

- Die stamped with high quality 20 gauge sheetmetal
- Features all of the original contour and mounting detail
- Beautiful edge bead with inner reinforcement rod just like the original design
- Black EDP coated
- Sold individually, please specify left or right hand side

**B24033** L/H - 1 Pc. / Box

**B24034** R/H - 1 Pc. / Box



**Front Fender Brace For 1932 Ford Passenger Car & Truck**

- Made of heavy duty 11 gauge steel
- Exact curvature as the original for easy installation
- Features all of the mounting holes for chassis, fender, and headlight bar
- Black EDP coated

**B20330** 1 Pc. / Bulk

**1964.5-70 Ford Mustang**



**Chrome Front Bumper for 1967-68 Ford Mustang**

- Made with heavy gauge sheet metal
- Features all original contour and detail
- Precision punched square mounting bolt holes for easy and quick installation
- Show ready chrome plating finish

**110484** 1 Pc. / Box



**Chrome Rear Bumper for 1967-68 Ford Mustang**

- Made of heavy duty 13 gauge steel
- Beautifully chrome plated with triple plating process
- Features all the original contour and detail
- Precision punched square carriage bolt holes for straight forward installation

**110487** 1 Pc. / Box



**Chrome Front Bumper for 1964.5-66 Ford Mustang**

- Made of heavy duty 13 gauge steel
- Beautifully chrome plated with triple plating process
- Features all the original contour and detail
- Precision punched square carriage bolt holes for straight forward installation

**110483** 1 Pc. / Box



**Door Glass Mounting Bracket & Guide Kit for 1969-70 Ford Mustang**

- Heavy duty 13 gauge steel mounting brackets
- High quality 14 gauge steel regulator guide brackets
- Accurate reproduction with all original contour detail and cutouts
- Mounting hardware included
- Sold individually, please specify left or right hand side

**110642** R/H - 1 Set / Box

**110643** L/H - 1 Set / Box

## 1954-59 Chevy Truck

### Painted Rear Bumper Fits Stepside For 1955-59 Chevy & GMC Truck

- Made of heavy duty 12 steel
- Features all the original contour and detail
- Precision punched square carriage bolt holes for straight forward installation
- Mounting holes and recess for license plate bracket
- Black powder coated finish



110726 1 Pc. / Box

### Painted Front Bumper For 1955-59 Chevy & GMC Truck

- Made of heavy duty 12 steel
- Features all the original contour and detail
- Precision punched square carriage bolt holes for straight forward installation
- Feature recess for the license plate
- Black powder coated finish



110728 1 Pc. / Box

### Painted Rear Bumper For 1954-55 Chevy & GMC Truck

- Made of heavy duty 12 steel
- Features all the original contour and detail
- Precision punched square carriage bolt holes for straight forward installation
- Black powder coated finish



110731 1 Pc. / Box

## Ford Parts



### Firewall Support Brackets For 1948-52 Ford Truck (4Pcs/Set)

- Die stamped with high quality 14 & 16 gauge sheetmetal
- Identical shape and size exactly like the original design
- Features all of the original designed strengthening ribs
- Finished with United Pacific Classic-Coat® weldable primer

110734 1 Set / Box



### Fender Apron for 1966-77 Ford Bronco

- Die stamped with high quality 19 gauge sheetmetal
- Features all of the original contour and mounting detail
- Coated with weldable primer for easy body attachment
- Sold individually, please specify left or right hand side

110364 R/H - 1 Pc. / Bulk

110365 L/H - 1 Pc. / Bulk

## Chevy Parts

CHEVROLET

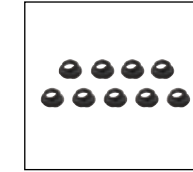

### Chrome "Chevrolet" Hood Letter Emblem Set for 1967-68 Chevrolet Truck

- Beautiful chrome plated die cast
- Identical mounting stud location exactly like the original design for easy replacement
- Speed nuts included
- OEM GM # 3892085
- GM Restoration licensed product

110057 1 Pc. / Card



### Cargo Light Mounting Pad for 1969-72 Chevy & GMC Truck

- Rubber mounting pad only
- Made of high quality durable black rubber

110149 1 Pc. / Bulk



### Incandescent Tail Light Lens for 1953 Chevy Passenger Car

- High quality plastic injection molded red polycarbonate lens
- exactly like the original design with painted base
- Marked with "guide R1-53" and "5943406" script
- OEM number 5943406
- GM restoration licensed product

C4007 1 Pc. / Bulk



### Incandescent Tail Light Lens with Blue Dot for 1953 Chevy Passenger Car

- High quality plastic injection molded red polycarbonate lens
- Blue dot with chrome ring installed

C4007-1 1 Pc. / Bulk

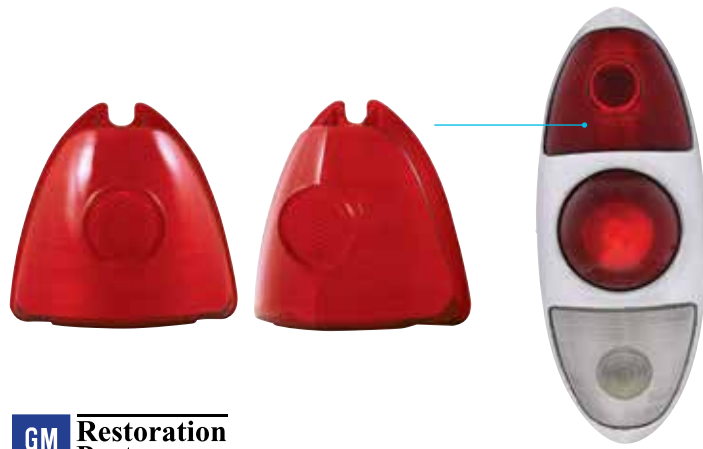

**GM Restoration Parts**

### Incandescent Upper Outer Tail Light Lens for 1953 Chevy Passenger Car

- High quality plastic injection molded red polycarbonate lens
- Exactly like the original design with raised center reflector
- Marked with "guide RI-53" & "5943403" script
- OEM number 5943403
- GM restoration licensed product

**C4006** 1 Pc. / Bulk

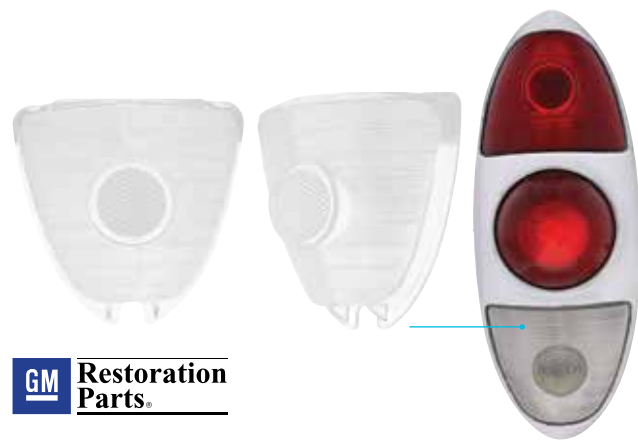

**GM Restoration Parts**

### Incandescent Backup Lens for 1953 Chevy Passenger Car

- High quality plastic injection molded clear polycarbonate lens
- Exactly like the original design with raised center reflector
- Marked with "guide RI-53" & "5943404" script
- OEM number 5943404
- GM restoration licensed product

**C4027** 1 Pc. / Bulk

### Light Bulb

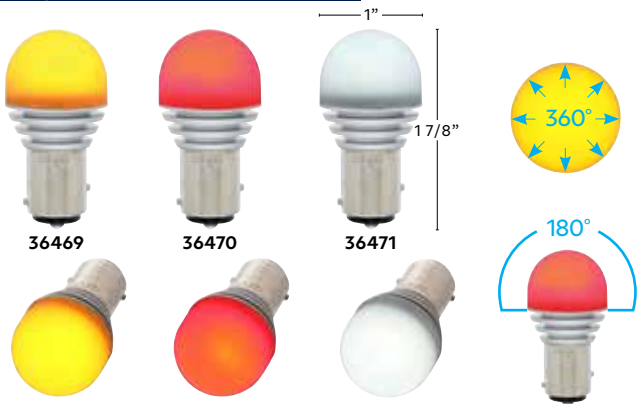

### High Power 1157 LED Bulb

- Dual function LED bulb: high 275 lumens/low 150 lumens
- 360° glow design
- Long life sealed design

**36469** Amber - 1 Pc. / Card  
**36470** Red - 1 Pc. / Card  
**36471** White - 1 Pc. / Card



### Xenon White 9007 Halogen Bulb

- 12V 9007 halogen bulb
- Hi/Low function
- High beam 100 watt/low beam 80 watt

**39132** 1 Pair / Clamshell

### Chrome Small 4 Trumpet Air Horn

- Extra loud air horn in compact size
- Universal application, perfect for all vehicles
- Deluxe chrome finish
- Mounting hardware included
- Technical specifications:
  - Height of the 4 horns: 9 3/8" & 11 7/8"
  - Dia of the 4 horns: 3 5/8"
  - Horn Base: 5 3/8" x 6 1/8"
  - Solenoid valve voltage: 12VDC
  - Decibel Rating: 130db ± 10db

**46155** 1 Pc. / Color Box



**COMPETITION SERIES**

### Jeep Wrangler Parts



### Headlight Assembly for 1997-2006 Jeep Wrangler

- Excellent OEM style headlight bracket: item number 110383/110384
- Includes 7" quartz halogen sealed beam bulb - UP item number 30356
- Sold individually, please specify left or right hand side

**110799** L/H - 1 Pc. / Card  
**110800** R/H - 1 Pc. / Card



### Headlight Bracket for 1997-2006 Jeep Wrangler

- Excellent OEM style headlight bracket for the 1997-2006 Jeep Wrangler
- Plastic injection molded high quality durable plastic material
- Sold individually, please specify left or right hand side

**110383** L/H - 1 Pc. / Card  
**110384** R/H - 1 Pc. / Card

### Display for 4" x 6" DOT Headlight

- Attractive counter top display with interactive push buttons
- Ready to use, requires 110V outlet
- Creates customer demand to drive sales

**99124** 1 Pc. / Box



**DOT & SAE APPROVED**

### Display for 4" x 6" Rectangular Light

- Attractive counter top display with interactive push buttons
- Ready to use, requires 110V outlet
- Creates customer demand to drive sales

**99125** 1 Pc. / Box



### Headlight Assembly for 2007-2016 Jeep Wrangler

- Excellent OEM style headlight bracket: item number 110383/110384
- Includes 7" H4 quartz halogen crystal headlight bulb - UP item number: 31387
- Sold individually, please specify left or right hand side

**110801** L/H - 1 Pc. / Card  
**110802** R/H - 1 Pc. / Card

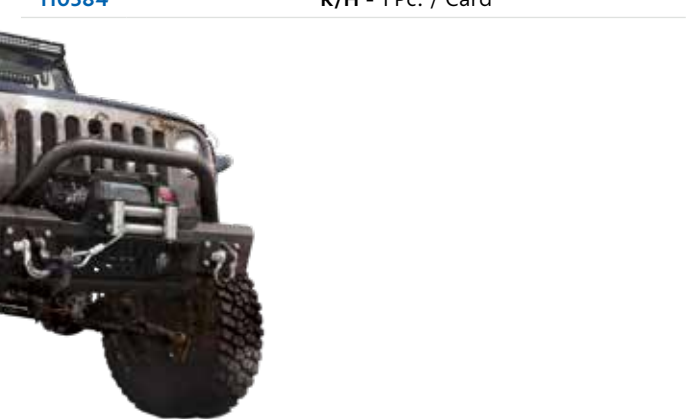

### Headlamp Bracket for 2007-2016 Jeep Wrangler

- Sold individually, please specify L/H or R/H side
- OEM #: 55078149AC

**110585** L/H - 1 Pc. / Box  
**110586** R/H - 1 Pc. / Box



# NEW ITEMS

October 2018

## Parts & Accessories for Ford, Chevy Truck & Mustang



B21075

B21076



### Cowl Top for 1932-34 Ford Truck

- High quality 18 gauge die-stamped sheet metal reproduction
- Identical curvature as the original
- Feature windshield opening flange and cowl band channel
- Coated With United Pacific Classic-Coat® weldable primer
- Cowl vent inner drain base sold separately

B21075	with Vent Opening - 1 Pc. / Box
B21076	without Vent Opening - 1 Pc. / Box



### Cowl Side Panel for 1932-34 Ford Truck

- Made with high quality 18 gauge die-stamped sheet metal
- Identical curvature as the original
- Feature windshield pillar to factory seam with original style lead-fill valley for roof attachment
- Precision machine cut door hinge notches
- Coated With United Pacific Classic-Coat® weldable primer
- Sold individually, please specify L/H or R/H side

B21077	L/H - 1 Pc. / Box
B21078	R/H - 1 Pc. / Box

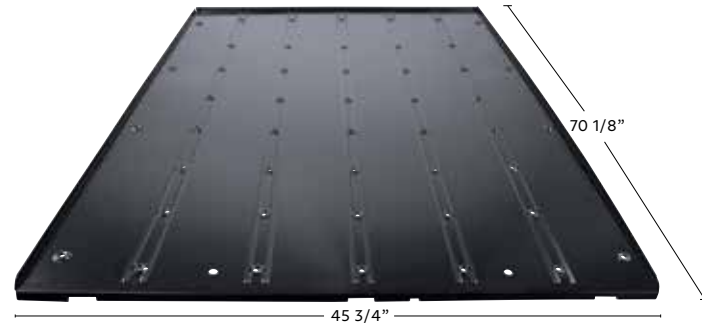

### Truck Bed Floor for 1932 Ford Truck

- High quality reproduction of the original 1932 bed floor with strengthening ribs in 18 gauge steel
- Features original style countersink holes for bed floor mounting screws
- Black EDP coated
- Truck freight only

B21510	1 Pc. / Bulk
--------	--------------



### Cowl Inner Braces for 1932 Ford Truck

- Excellent sheet metal reproduction
- Identical curvature as the original
- Feature mounting hole and pass-through for vacuum line
- Machine punched rivet holes for straight forward installation to A-Pillar and Cowl Band
- Sold as pair

B21079	1 Pair / Box
--------	--------------



### Lower Rear B-Pillar Braces for 1932-34 Ford Truck

- Heavy duty sheet metal reproduction
- Identical design as the original
- Machine punched rivet holes for straight forward installation to B-Pillar and Rear Floor Panel
- Black EDP coated
- Sold as pair

B21027	1 Pair / Box
--------	--------------

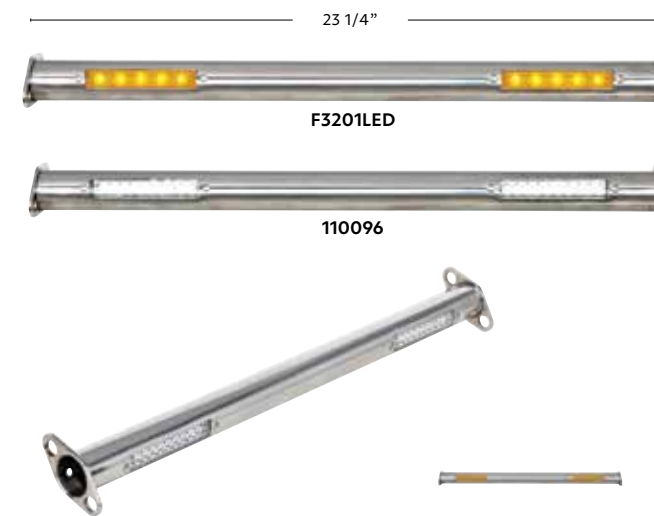

### LED Front Spreader Bar for 1932 Ford Car & Truck

- Now available with white LED running lights. Amber version is available for turn signal.
- Polished stainless steel spreader bar with hidden welds
- Wires exit on each side near mounting flange, and can be easily hidden along inside frame rail
- Solid state circuit board engineered for any 12VDC system
- Includes polished stainless steel button head bolts with stainless nylock nuts

110096	With White Running Lights - 1 Pc. / Box
F3201LED	With Amber Turn Signals - 1 Pc. / Box

## 1966-77 Ford Bronco



### Chrome "FORD" Grille Letter Set for 1966-77 Ford Bronco

- High quality die cast & chrome plated with gloss red inlay
- 8 speed nuts included
- Excellent upgrade for all 1966-77 Ford Broncos
- Official licensed product by Ford Motor Company

110482	1 Set / Card
--------	--------------

**1967-68 Ford Mustang**



**Eleanor Style Fiberglass Trunk Lid for 1967-68 Ford Mustang Fastback**

- Fiberglass outer skin with steel inner skeleton
- Identical design as the original
- Will require Eleanor style quarter panel extensions, sold separately

**110654** 1 Pc. / Box



**Black Steel Low Rise Eleanor Style Hood for 1967-68 Ford Mustang with 67 Shelby Front End**

- All-steel "Eleanor" style hood which is extra long at the front to match up with the Eleanor/Shelby style nose for those converting over to the "Eleanor" style Mustang
- This is NOT a bolt-on stock replacement hood and you must have the Eleanor/Shelby Style Extended Nose for This Hood to Fit Properly
- Black EDP coated
- Oversize freight policy

**110648** 1 Pc. / Box

**Chevy Parts**



**Fiberglass Nose Panel for 1967-68 Ford Mustang Coupe/Convertible/Fastback - Eleanor Style**

- Excellent reproduction of Iconic Eleanor Mustang
- Feature two recesses on the bottom for lower grille round lights
- Require 1967 Shelby style hood, will not work with stock length Mustang hoods

**110649** 1 Pc. / Box



**White Painted Grille for 1957 Chevy Truck**

- Excellent steel reproduction of the original truck grille
- 5/16-18 nuts pre-welded to grille for easy and quick installation
- Powdered coated with original factory color look

**110390** 1 Pc. / Box



**29 Red LED Sequential Tail Light for 1954-59 Chevy & GMC Truck with Black Housing**

- Super bright red LED with fully sealed epoxy coated electronics
- Selector switch to control sequential function off, direction left, or direction right
- Also features a brake attention option with a sequential-once function
- 1157 double connector with offset pins, plugs into existing tail lamp socket
- Requires use of United Pacific LED turn signal flasher, item number: 90652 or 90649
- DOT & SAE Approved

**110767** 1 Pc. / Box

**LED 3rd Brake Light**



**33009**



**33010**



**33013**



**10 LED 3rd Brake Light with Adjustable Pedestal Base**

- Designed with adjustable base mount for inside rear window installation
- Available with split LED function for lefthand & righthand turn signal
- Available with running light and brake light
- Base swivels 180° for multiple application

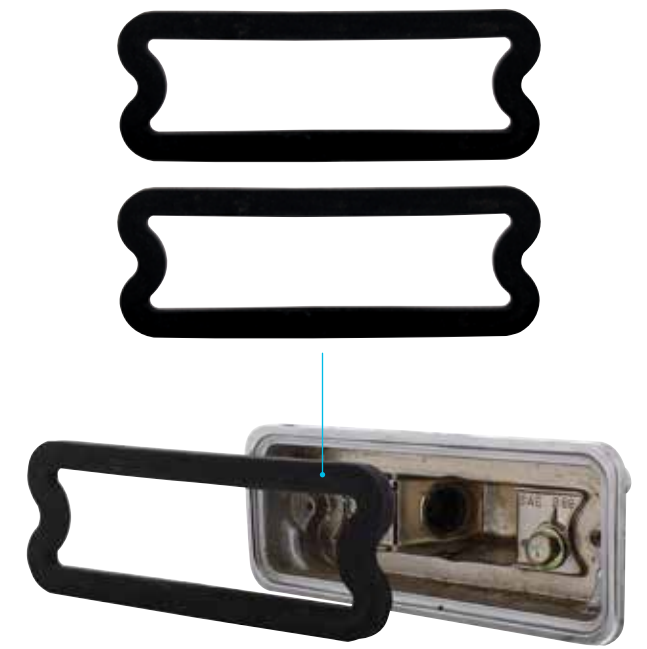

**Backup Lens Gasket Set for 1969-72 Chevy Camino**

- Made of high durability foam material
- Precision cut to exactly shape as the original for a tight seal

**110459** 1 Pair / Bulk

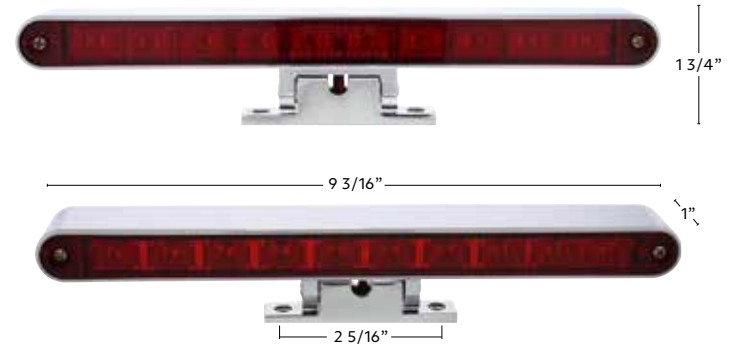

**Split Dual Function Versions:**

**33010** Split Function Red LED/Red Lens - 1 Pc. / Card

**Regular Dual Function:**

**33009** Dual Function Red LED/Red Lens - 1 Pc. / Card

**33013** Dual Function Red LED/Clear Lens - 1 Pc. / Card

## Universal Products



### 2" Hitch Cover

- Fits standard 2" x 2" tow hitch receivers
- Mounts in place with standard hitch pin & clip (Sold separately 77051)
- Keeps dirt and debris out of hitch receiver and gives a Super Clean Look
- Corrosion resistant, made of high quality plastic polymer

**77007** Chrome - 1 Pc. / Card

**77008** Black - 1 Pc. / Card

## Light Bulb



### High Power 1156 LED Bulb

- Single function LED bulb with maximum 275 lumens
- 360° surround illumination, 180° front illumination
- Long life sealed design

**36465** Amber - 1 Pc. / Card

**36466** Red - 1 Pc. / Card

**36467** White - 1 Pc. / Card

## LED Headlight



### Technical Specification

Low Beam Application	High Beam Application
12V 1.2A / 24V 0.6A	12V 1.3A / 24V 1.0A
1,000 Lumens	2,000 Lumens

### 7" High Power LED Headlight with LED Position Light Bar

- High power led headlight with 2 LED position light bar for powerful performance
- Dual function headlight: low beam & high beam
- Aluminum housing with proprietary heat management provides maximum protection for long-lasting performance
- Solid state design resists shock and vibration
- Easy connection, fits OEM housing or fender, plugs into existing wiring harness, position light requires additional wiring
- DOT/SAE headlight approved

**31200** 1 Pc. / Color Box



### High Power 9006/HB4 LED Bulb

- 20W low beam application
- 4500 lumen output
- Forced convection design with cooling fan and heat sink, to increase service life
- Includes driver/controller for easy installation, made to fit most 9006/HB4 bulb
- Driver/controller is approximately 2 1/4" L x 15/16" W x 5/8" H

**36513** 1 Pair / Color Box

# NEW ITEMS

November & December 2018

## Parts & Accessories for Ford, Chevy Truck & Mustang

### 1932 Ford 5W & Roadster



### Rear Fender for 1932 Ford 5W Coupe & Roadster

- Quality stamped steel, exactly like the original design
- Made of excellent 20 gauge sheetmetal
- Fender edge bead with steel inner wire
- Precision punched quarter panel mounting holes
- Includes mounting holes for frame horn cover
- Black EDP coated
- Sold individually, please specify left or right hand side

**B20333** L/H - 1 Pc. / Box

**B20334** R/H - 1 Pc. / Box



## 1932-34 Ford Truck



### Upper Door A-Pillar Cover for 1932-34 Ford Truck

- Die stamp quality 19 gauge sheetmetal
- Accurate reproduction of the original to cover the corner of A-pillar and roof
- Finished with United Pacific Classic-Coat® weldable primer
- Sold individually, please specify L/H or R/H side

**B21121** L/H - 1 Pc. / Bulk

**B21122** R/H - 1 Pc. / Bulk



### Inner Lower A-Pillar Reinforcement for 1932-34 Ford Truck

- Heavy duty 13 gauge steel reproduction
- Die stamp with special attention to all detail to match the original
- Features square carriage bolt holes for chassis & floor installation
- Spot welding pass-thru holes for OE style A-Pillar mounting
- Center strengthening rib exactly like the original
- Black EDP coated
- Sold individually, please specify L/H or R/H side

**B21129** L/H - 1 Pc. / Bulk

**B21130** R/H - 1 Pc. / Bulk

**For Ford Bronco**



**13 Gal Main Fuel Tank for 1966-77 Ford Bronco**

- Die stamped with Ni-Terne treated steel sheet
- Approximately 13-gallon fuel capacity
- Precision notched fuel tank strap recesses for better positioning during installation
- Includes locking ring and o-ring

110561 1 Pc. / Box



**Grille without Logo for 1969-77 Ford Bronco**

- Die stamped with high quality 17 gauge sheet metal
- Feature all of the original contour detail and mounting brackets for the larger round signal lights
- Smooth design to keep that clean front end look
- Black powder coated finish
- Headlight adjusters included

110515 1 Pc. / Box

**For Ford Truck**



**Door Check Arm for 1948-52 Ford Truck**

- Original style with durable rubber stop
- Includes solid rivet and cotter pin
- Fits both L/H & R/H

110790 1 Pc. / Box



**Aluminum Cab Back Molding with for 1967-72 Ford Truck**

- Quality aluminum extrusion
- 66-3/4" overall length when assembled
- Highly polished face to a show ready chrome finish
- Corner end pieces not included
- Mounting hardware included

110026 1 Set / Box



**18' Roll of Fender Flare Welting for 1966-77 Ford Bronco**

- Welting mounts between the flare and the body to provide a finished edge
- 3/16" bead, 1 1/4" wide, 1/16" thick
- Heat & UV resistant black PVC material
- Each 18' roll is enough for 2 Bronco flares
- Requires 2 sets for a full Bronco

110539 1 Roll / Bulk



**Tailgate Still Plate for 1978-86 Ford Bronco**

- Quality aluminum extrusion
- Clear anodized finish
- Machine drilled mounting hole with countersink
- Mounting hardware included

110791 1 Pc. / Box

**1964.5-68 Ford Mustang**



**Racing Style Fiberglass Front Valance with Light Cutout for 1964.5-66 Ford Mustang**

- High quality sheet molded compound
- Accurate reproduction with all original contour detail
- Feature racing style design front parking light cutouts

110491 1 Pc. / Box



**Racing Style Fiberglass Front Valance with Light Cutout for 1967-68 Ford Mustang**

- High quality sheet molded compound
- Accurate reproduction with all original contour detail
- Feature racing style design front parking light cutouts

110492 1 Pc. / Box



### Eleanor Style Quarter Panel Extensions/End Caps for 1967-68 Ford Mustang Fastback

- Made of high quality sheet molded compound
- Matte black painted finish
- Each side has 3 overmolded mounting studs
- Mounting hardware included

**110655** 1 Pair / Box

### Eleanor Style Fiberglass Trunk Lid for 1967-68 Ford Mustang Fastback

- Fiberglass outer skin with steel inner skeleton
- Identical design as the original
- Will require Eleanor style quarter panel extensions, sold separately

**110654** 1 Pc. / Box



### Vent Window Assembly for 1964.5-66 Ford Mustang

- Highly polished stainless steel glass frame
- Factory assembled with high quality rubber seal
- Exactly like the original design for a straight forward replacement
- Period correct chrome vent window handle
- Includes door glass channel with felt
- Available with crystal clear non-tinted tempered window glass or original style green tinted tempered window glass
- Sold individually, please specify L/H or R/H side

**110778** R/H Clear - 1 Pc. / Box  
**110779** L/H Clear - 1 Pc. / Box  
**110780** R/H Tint - 1 Pc. / Box  
**110781** L/H Tint - 1 Pc. / Box



### Vent Window Assembly for 1967 Ford Mustang

- Highly polished stainless steel glass frame
- Factory assembled with high quality rubber seal
- Exactly like the original design for a straight forward replacement
- Period correct chrome vent window handle
- Includes door glass channel with felt
- Available with crystal clear non-tinted tempered window glass or original style green tinted tempered window glass
- Sold individually, please specify L/H or R/H side

**110782** R/H Clear - 1 Pc. / Box  
**110783** L/H Clear - 1 Pc. / Box  
**110784** R/H Tint - 1 Pc. / Box  
**110785** L/H Tint - 1 Pc. / Box

### Chevy & GMC Trucks



### Black Painted Running Board for 1947-54 Chevy & GMC Shortbed Truck

- Excellent quality 18 gauge sheetmetal
- Ribbed style just like original
- Underside retainer brackets pre-welded for easy installation
- Painted black to help protect against rust during installation and shipment
- Sold individually, please specify L/H or R/H side

**170471** L/H - 1 Pc. / Box  
**170472** R/H - 1 Pc. / Box



### Bedside Step for 1955-66 Chevy & GMC Shortbed Truck

- High quality 17 gauge steel reproduction
- Ribbed style just like original
- Precision punched square carriage mounting bolt holes
- Painted black to help protect against rust
- Sold individually, please specify L/H or R/H side

**170551** L/H - 1 Pc. / Box  
**170552** R/H - 1 Pc. / Box



### Bedside Step for 1955-66 Chevy & GMC Truck Longbed Truck with 7-1/2 Foot Bed

- High quality 17 gauge steel reproduction
- Ribbed style just like original
- Precision punched square carriage mounting bolt holes
- Painted black to help protect against rust
- Sold individually, please specify L/H or R/H side

**170553** L/H - 1 Pc. / Bulk  
**170554** R/H - 1 Pc. / Bulk



### Black Painted Rear Bumper for 1960-62 Chevy & GMC Fleetside Truck

- Die stamped with heavy 12 gauge sheet metal
- Features identical curvature exactly like the original design
- 4 precision punched square carriage bolt holes for straight forward installation
- 2 square carriage bolt holes for license plate bracket
- Painted black to help protect against rust

**110724** 1 Pc. / Box

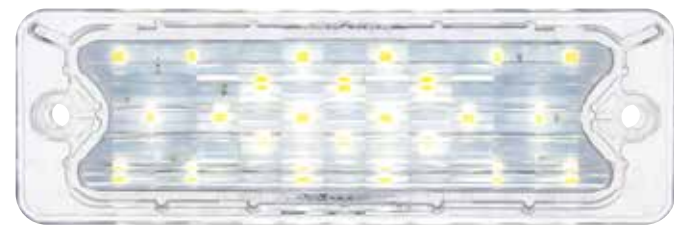

### 24 White LED Back-Up Light for 1969-72 Chevy El Camino

- 1156 single contact, straight pins
- Epoxy coated, fully sealed electronics
- Easy installation, fits existing bezel and housing
- Solid state circuit boards are designed at 7.7-14.0 VDC

**110458** 1 Set / Card



### 29 Red LED Sequential Tail Light for 1954-59 Chevy & GMC Truck with Housing

- Super bright red LED with fully sealed epoxy coated electronics
- Selector switch to control sequential function off, direction left, or direction right
- Also features a brake attention option with a sequential-once function
- 1157 double connector with offset pins, plugs into existing tail lamp socket
- Requires use of United Pacific LED turn signal flasher, item number: 90652 or 90649
- Available with stainless and black housing
- DOT & SAE approved

**110767** **Black** - 1 Pc. / Box

**110768** **Stainless** - 1 Pc. / Box



### Backup Light Housing Gasket for 1969 Chevy Camaro

- Made of high durability foam material
- Precision cut to exact shape as the original for a tight seal

**110451** 1 Pair / Bulk



**110765**

**110766**



### 29 Red LED Tail Light for 1954-59 Chevy & GMC Truck with Housing

- Super bright red LED with fully sealed epoxy coated electronics
- 1157 double connector with offset pins, plugs into existing tail lamp socket
- Requires use of United Pacific LED turn signal flasher, item number: 90652 or 90649
- Available with stainless and black housing
- DOT & SAE Approved

**110765** **Black** - 1 Pc. / Box

**110766** **Stainless** - 1 Pc. / Box



**31458**



**31459**



### Technical Specification

**Low Beam Application**  
900 Lumens  
25 Watt / 5700K

**High Beam Application**  
1,300 Lumens  
25 Watt / 5700K

### High Power LED 7" Headlight with LED Turn Signal/Position Light Bar

- High power LED headlight with LED turn signal/position light bar for powerful performance
- Aluminum housing with proprietary head management provides maximum protection for long-lasting performance
- Solid state design resists shock and vibration
- Easy connection, fits OEM housing or fender, plugs into existing wiring harness, position light requires additional wiring
- DOT/SAE headlight approved

**31458** **Turn Signal & Amber Position Light Bar** - 1 Pc. / Color Box

**31459** **White Position Light Bar** - 1 Pc. / Color Box



### Rear License Plate Bracket w/Light for 1954-59 Chevy Truck

- Die stamped with high quality 17 gauge sheet metal
- Original style license plate light with quality glass & metal enclosure
- Single positive lead wire with quick connector pre-installed for easy electrical hookup
- Original style large riveted license plate bracket
- Black EDP coated

**110770** 1 Pc. / Bulk



**31168**



**31237**



### Technical Specification

**Low Beam Application**

12 - 24V DC Input 0.35 Amps / 8.5 Watt FMVSS108

### High Power LED 4" x 6" Rectangular Headlight with 6 LED Position Lights

- 1 high power LED headlight with 6 LED position light
- Available in single function white LED and dual function amber LED
- Die cast aluminum housing provides maximum protection from the elements
- Solid state design resists shock and vibration
- Improve visibility with light output that is closer to the color temperature of daylight

**31168** **White LED/Single Function** - 1 Pc. / Color Box

**31237** **Amber LED/Dual Function** - 1 Pc. / Color Box



### Rear License Plate Bracket w/Light for 1960-66 Chevy Truck

- Die stamped with high quality 17 gauge sheet metal
- Original style license plate light with quality glass enclosure
- Single positive lead wire with quick connector pre-installed for easy electrical hookup
- Precision cut bumper and license plate mounting holes
- Black rubber insert help reduce rattling noise from license plate
- Black EDP coated

**110771** 1 Pc. / Bulk

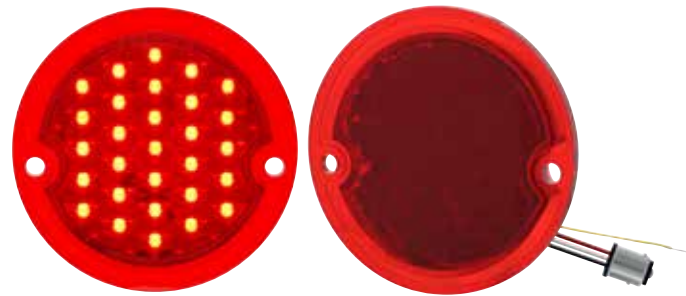

### 29 Red LED Tail Light for 1954-59 Chevy & GMC Truck

- Super bright red LED with fully sealed epoxy coated electronics
- 1157 double connector with offset pins, plugs into existing tail lamp socket
- Requires use of United Pacific LED turn signal flasher, item number: 90652 or 90649

**110404** 1 Pc. / Card



### 16 GAL Zinc Plated Fuel Tank for 1982-86 Chevy & GMC Shortbed Truck

- 110675
- 110671
- 110673

### 16 GAL Zinc Plated Fuel Tank for 1982-86 Chevy & GMC Shortbed Truck

- Die stamped with Ni-Terne treated steel sheet
- Has all original contour detail and mounting holes
- Machine welded for an even and complete seal

**110684** 1 Pc. / Box

### Universal Products



**34103**

**34102**



### License Plate Light Lens for 1990-2004 Ford Truck

- OEM style with mounting tabs for easy installation
- High quality plastic housing in chrome plated with triple chrome plating process or painted black finish
- OEM number: F67Z-13550-AA/ F67Z-13550-A

**34102** **Chrome** - 1 Pc. / Card

**34103** **Black** - 1 Pc. / Card

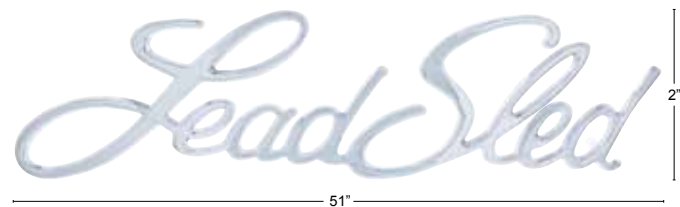

### Chrome "Lead Sled" Script Emblem

- Chrome diecast "Lead Sled" script emblem
- Easy installation with 5 studs, mounting clips included

**110709** 1 Pc. / Card

### Merchandising



### United Pacific Analog Neon Wall Clock

- Nostalgic blue neon light design
- Chrome plate outer bezel
- Clock face features beautiful shot of the UPI's 1932 5-Window Coupe built by Roy Brizio, and customized UPI sponsored Cascadia

**99049** 1 Pc. / Color Box



### 12 Blanket Bin Box Display - 50" x 60" Flannel Fleece Comfort Blanket

- Includes 3 each of the following
- 99113 - Navy blue blanket
- 99114 - Red blanket
- 99115 - Ash black blanket
- 99116 - Green blanket

**99133** 1 Set / Bulk



### 9 High Power LED Work Light Bin Box Display

- Includes 4 each of the following
- 36617 - 9 high power round led work light
- 36618 - 9 high power square led work light

**99134** 1 Set / Bulk



### United Pacific Metal Cooler Box

- Retro style 1940's-1950's metal picnic cooler
- Beautiful blue painted steel exterior with chrome plated carrying handle and corner protectors
- Aluminum lined interior keeps contents cool and fresh
- Convenient built-in bottle opener on side
- Great counter display for retail stores, man cave, RV, etc.

**99118** 1 Pc. / Box



**1966-77 Ford Bronco Product Catalog Item # ACBR01**



**The Official 1932-34 Ford Truck & 1932 5 Window Coupe Product Catalog, Item # AC3209**



**United Pacific Ford Bronco Poster Item # 99130**



**United Pacific 32 Ford Truck Poster Item # 99112**

**Available Now!**

# TERMS & CONDITIONS / ORDERING GUIDELINES / FREIGHT

IMPORTANT: PLEASE REVIEW CAREFULLY

## New Accounts:

Initial minimum buy-in is \$2,000 (or to be determined by United Pacific Industries, UPI hereafter). All initial orders must be prepaid in advance by Cashier's Check or VISA/MC. All new/potential accounts must complete a UPI "New Customer Info/Credit Form" and follow the Dealer Qualification Instructions. Upon completion of the credit application, approved accounts will be assigned payment terms of NET 30 Days (from invoice date). Accounts denied a credit line will be required to prepay in advance by Cashier's Check or VISA/MC.

## PAYMENT TERMS

### Term Accounts:

Accounts with NET 30 Days terms are required to submit payment within the 30 days from the date of invoice. Acceptable forms of payment include checks, ACH (Automated Clearing House), or wire transfer.

A service charge of 1.5% per month will be imposed on invoices not paid within the 30 day term. Delinquent accounts will be required to pay Cash-In- Advance (CIA). Checks will be accepted but orders will not be released until the check is cleared by the bank. Past due invoices will delay current orders. Please check with UPI on your account status when placing an order.

### Credit Cards

Accounts denied credit terms may pay by Visa or MasterCard. Credit card will be charged upon shipment. Credit card payments will not be accepted once an order has been shipped. UPI does not accept American Express or Discover card.

### COD

A \$9.00 fee will be assessed per COD box for all FedEx/UPS COD shipments. Truck COD shipment fees are to be determined later by trucking company.

### Returned Checks:

A \$30 NSF (Non Sufficient Fund) fee will be assessed on each incidence a check is returned to UPI.

## ORDERING GUIDELINES

Placing Orders: New orders may be placed by any of the following methods

1. Fax: **888.986.6088**
2. E-mail: [antique@upauto.com](mailto:antique@upauto.com)
3. Telephone: In order to minimize errors, customers are encouraged to submit their orders by fax or email. Telephone orders should be limited to smaller orders such as add-ons to orders already submitted and/or fill-ins occurring between larger restocking orders.

### Changes to Orders:

Whenever possible, revisions to orders - additions or deletions of items - should also be submitted via fax or email to reduce the possibility of errors.

Additions/Deletion of items will only be accepted within 48 hours after the initial order date and/or before 12:00PM on the date of the shipment. Additions of items placed after the 48 hours time period will be considered a new order and adhere to a new order freight prepaid policy. Deletions of item cannot happen after the 48 hours time period and/or after 12:00PM on the date of the shipment. Please note additions and/or deletions of items will delay the shipment date.

### Canceling Orders:

Cancellation of orders must be submitted via fax or email within 24 hours of the order date. If the order has already shipped it will be the customers responsibility to return the order at the customers own expense. A restocking fee may apply, please see "Return" policy for further detail.

## Backorders:

Customers have the option of having their backorders shipped or canceled. UPI will notify customer as to availability of backorders and will be able to ship any backorder items customer still needs as part of their next stock order. UPI reserves the right to cancel backorders that are 6 months or older from the initial invoice date.

## Minimum Order:

A minimum order of \$50.00 is required. Orders below \$50.00 will be assessed a minimum order fee of \$10.00.

## Packaging:

A 10% service charge will be added to orders with special packaging or UPC barcoding requirements.

## Lead Times:

Standard lead time for all United Pacific orders is 1-3 business days from the receipt of the purchase order. Larger orders may require a lead time of up to 5 business days. Transit time of 3-5 business days must be considered when placing orders. UPI cannot be responsible for delays in shipment after an order leaves our warehouse. UPI will work to resolve delays with freight forwarding firms, however, delays do arise from time to time due to weather and unforeseen circumstances beyond UPI's control. Express order are exempted; please view Freight/Shipping Policy for further detail.

## Order Confirmation:

United Pacific will acknowledge receipt of orders by email/fax/telephone within 1 business day of receipt. If confirmation is not received, please contact UPI to ensure your order was received.

## FREIGHT

### Prepaid Freight:

Stock orders between \$50 and \$999.99 (US Lower 48 States), **\$50 and \$2499.99 (Alaska and Hawaii)**, **\$50 and \$1499.99 (Canada)**, [all price net US\$], will be shipped FOB Long Beach, California. Stock orders of \$1,000 (US Lower 48 States), **\$2500 (Alaska and Hawaii)**, **\$1500 (Canada)**, [based on UPI current pricing], or more will be shipped Freight Prepaid Ground to a single location only. (See exception for Oversize Items\*). Express Air orders, Special Net Pricing orders, and Special Quote Pricing orders are excluded. United Pacific reserves the right to select the carrier of our choice. Customers may select the carrier of their choice at their own expense, negotiated rates and insurance. If customers elect to choose their own freight carrier, orders will be shipped via FREIGHT COLLECT. **Oversize Item Freight Policy** – Applies to 1932 Ford car & truck body shell assemblies, 1932 Ford car & truck body parts such as floor assembly, roof, door, fender, quarter panel, grille, bulk rail gutter, bulk roof tack strip, chassis & frame, wheels & tire, and any exceptionally large or heavy item.

1. Freight will be prepaid by United Pacific if the total order of all items exceeds \$4,000 (US Lower 48 States) or **\$5000 (Hawaii, Alaska and Canada)**, [all price net US\$]. There will not be additional charges for these items included on the order.
2. Freight will be prepaid by United Pacific if a customer orders a total of \$2,500 (US Lower 48 States) or **\$3500 (Hawaii, Alaska and Canada)**, [all price net US\$], of PB 379 fenders, 60" or longer exhaust, and/or 18"+ Longer Saddle Boxes only. If the order is below \$2,500 (US Lower 48 States) or **\$3500 (Hawaii, Alaska and Canada)**, United Pacific will add freight charges to the order for the oversize items.

## Will Call Orders:

Will Call orders can be picked up 2 - 4 hours after placing the order. Customers should always call ahead to confirm when order will be ready to pick up.

# SHIPPING POLICY / CLAIMS

IMPORTANT: PLEASE REVIEW CAREFULLY

## SHIPPING POLICY

### International Shipments:

Shipments to locations outside the continental United States will be shipped to the customer's shipping agent or broker within the continental United States in accordance with the US freight policy. International customers will be responsible for the duties and taxes of their respective country.

### Express Orders:

All express orders, such as Next Day, Second Day, 3 Day Service & Will Call, must be faxed/emailed. Order confirmation will be faxed to the customer for final approval. If confirmation is not received, please contact UPI to ensure your order was received. Customers are required to sign off on express orders and fax confirmation back to UPI. Cut off for express order is 12:00PM. Express orders received after 12:00PM may or may not ship the same day. Please call UPI to confirm projected shipping date or will call time.

Due to the high cost of express shipments, customer may request UPI to call to confirm freight charges. If customer does not request confirmation, UPI will ship the express order.

### Drop Shipments:

All drop shipment orders will be assessed a 5% processing fee. Drop shipment processing fee will be automatically added to the invoice without notice. All drop shipment orders must be faxed in. No freight allowance or prepaid freight will be permitted for any drop shipments, thus, all drop ship orders, regardless of order size, are FOB Long Beach, CA.

## CLAIMS

### General Policy:

All claims (Shortage, Mis-Shipped, Damage, Overage, Customer Error & Billing Error) must be submitted to UPI within 3 business days of the receipt of shipment. Claims submitted beyond 3 business days of the receipt of shipment will be voided by UPI.

On all shipments, the person who signs and receives the shipment is responsible for noting on the Bill of Lading, in writing, whether any boxes arrived damaged or shorted. Failure to do so will void all claim rights between all parties. UPI will have no recourse against the trucking company if customer does not note any damages or shortages on the Bill of Lading.

The customers receiving department must count and sign for the exact number of boxes received. Failure to follow the above instructions will void all claim rights between all parties.

### Shortages / Mis-Ships / Damages:

While UPI strives to fill every order with 100% accuracy, on occasion an item may get shipped in error or get damaged during shipping. In the event this occurs, please follow the process below. Note: This type of claim must be reported to UPI within three (3) business days of receiving the order.

1. Contact the United Pacific office to initiate the claim. To make it easy for you we have two acceptable methods for requesting the claim:
  - By e-mail : [returns@upauto.com](mailto:returns@upauto.com)
  - By fax : **888.986.6088**

**\* Note: To ensure you receive a timely credit, we cannot accept claim requests by phone.**
2. You will be required to provide the following information:
  - Your business name
  - Contact name and telephone number (in case we have questions)
  - Date the order was received

- A copy of the Packing List / Invoice noting the item number and quantity that was shipped in error or damaged during shipping.
  - Special instructions you have for us.
3. UPI will send a return label so you can ship the items back.
  4. Once we receive the miss-shipped/damaged item(s) a credit will be issued to your account on the next billing cycle.
  5. Shortages will be credit to the Customers' account, unless customer would like the shortages replaced.

### Overages:

UPI strives to provide our customers with the best customer service and products, in turn we would greatly appreciate any help from customer in notifying UPI of any shipping overages. Customers will be offered the option of retaining the merchandise or returning the merchandise to UPI at UPI's expense. If the items are to be returned, an RMA number and return shipping label will be provided.

### Customer Errors:

Any item or quantity ordered in error by the customer may be returned by contacting UPI for a RMA No.

1. To make it easy for you we have two acceptable methods for requesting the RMA:
  - By e-mail: [returns@upauto.com](mailto:returns@upauto.com)
  - By fax: **888.986.6088**

**\* Note: To ensure you receive a timely RMA credit, we cannot accept RMA requests by phone.**
2. You will be required to provide the following information.
  - \* Your business name
  - \* Contact name and telephone number (in case we have questions)
  - \* A list of the items number and quantity ordered in error
  - \* Special instructions you have for us
3. UPI will review the request to ensure the products are within the return period.
4. Once we have validated the request, United Pacific will issue an RMA number to the customer. In issuing the RMA approval, the following conditions will apply :
  - Returned items are subject to a 20% re-stocking fee.
  - Return shipping costs are the responsibility of the customer.
  - Items must not have any retail/price sticker on exterior packaging or they will be returned to the customer at customer's expense and no credit given.
  - Items must be in good condition with original packaging intact or they will be returned to the customer at customer's expense and no credit given.
  - Allow up to 30 days for the credit to be issued from the time the returned items are received.

### Billing Errors:

Billing errors should be reported to UPI within 3 business days of invoice receipt. Customers are asked to provide the invoice number, part number, and quantities in question. Once verified, UPI will issue a credit or an invoice for the difference in billing error.





## PRODUCT INDEX

ITEM #	PAGE #
31150	33
31151	33
31152	33
31153	33
31168	74
31200	67
31237	74
31458	74
31459	74
32051	34
32052	34
32053	34
32054	34
32787	34
32788	34
32789	34
32790	34
32791	34
32792	34
32793	34
32794	34
32795	34
32796	34
32797	34
32798	34
32799	34
32800	34
32801	34
32802	34
32803	34
32804	34
32805	34
32806	34
32807	34
32808	34
32809	34
32810	34
33009	66
33010	66
33013	66
34102	75
34103	75
34235	20
34235	28
36465	67
36466	67
36467	67
36469	61
36470	61
36471	61
36504	33
36505	47
36506	47
36509	27
36512	7

ITEM #	PAGE #
36513	67
36591	14
36592	14
36593	14
36594	14
36595	14
36596	14
36597	14
36598	14
36599	7
36600	18
36601	18
36602	18
36603	18
36604	18
39132	61
40847	14
46155	62
50130	51
52000	48
52001	48
52002	48
52003	48
52004	48
52005	48
52006	48
52007	48
60050	13
60051	47
60052	47
60053	47
70092	48
70674	28
70708	19
90649	18
98998	8
99049	76
99053	7
99112	10
99113	48
99114	48
99115	48
99116	48
99118	76
99124	61
99125	61
99133	76
99134	76
110023	28
110026	70
110057	60
110095	51
110096	64
110128	20
110144	55

ITEM #	PAGE #
110145	55
110149	60
110174	5
110175	5
110176	5
110199	55
110218	10
110219	10
110221	10
110223	17
110233	25
110234	25
110253	56
110262	17
110263	17
110292	6
110293	6
110314	13
110331	51
110338	13
110354	51
110355	51
110364	59
110365	59
110366	36
110367	36
110368	36
110369	11
110370	11
110371	11
110372	11
110373	11
110383	62
110384	62
110390	65
110404	75
110405	55
110429	13
110451	73
110458	73
110459	66
110460	50
110461	50
110462	50
110463	49
110464	49
110465	50
110466	50
110470	17, 30
110471	30
110472	30
110473	17, 30
110474	51
110475	51
110476	6

ITEM #	PAGE #
110477	6
110478	7
110479	7
110482	64
110483	58
110484	46, 58
110485	46
110487	58
110488	24, 42
110489	24, 42
110490	42
110491	70
110492	70
110493	42
110494	43
110497	35
110498	43
110502	51
110504	25
110509	25
110510	25
110511	25
110512	25
110515	69
110522	37, 44
110523	37, 44
110535	11
110536	26
110539	69
110557	37
110561	69
110583	36
110584	36
110585	33, 62
110586	33, 62
110600	38
110601	38
110602	38
110603	38
110604	38
110605	38
110606	38
110607	38
110608	39
110609	39
110610	39
110611	39
110612	41
110613	41
110614	41
110615	41
110616	41
110617	41
110618	24
110619	24

ITEM #	PAGE #
110620	22, 40
110621	22, 40
110622	22, 40
110623	22, 40
110624	22, 40
110625	22, 40
110626	22, 40
110627	22, 40
110628	22, 39
110629	22, 39
110630	22, 39
110631	22, 39
110632	23, 41
110633	23, 41
110634	23, 41
110635	23, 41
110636	23, 41
110637	23, 41
110638	24
110639	24
110640	24
110641	24
110642	58
110643	58
110644	23
110644	42
110645	23
110645	42
110646	42
110647	42
110648	12
110648	65
110649	65
110650	12
110651	12
110652	12
110653	43
110654	65
110654	71
110655	71
110664	37
110665	37
110666	43
110667	16
110668	43
110669	44
110670	31
110671	32
110672	32
110673	32
110674	31
110675	32
110676	31
110678	44
110680	16

## PRODUCT INDEX

ITEM #	PAGE #
110682	16
110683	15
110684	75
110685	15
110686	15
110687	15
110688	15
110705	31
110709	75
110710	44
110718	54
110719	54
110720	54
110721	53
110722	53
110724	72
110725	54
110726	59
110728	59
110729	53
110730	53
110731	59
110733	54
110734	59
110741	21
110742	21
110743	21
110745	21
110746	21
110747	21
110748	27
110749	27
110750	21
110752	28
110765	73
110766	73
110767	66
110767	73
110768	73
110769	46
110770	74
110771	74
110778	71
110779	71
110780	71
110781	71
110782	71
110783	71
110784	71
110785	71
110790	70
110791	69
110796	56
110797	56
110798	56

ITEM #	PAGE #
110799	62
110800	62
110801	62
110802	62
170471	72
170472	72
170551	72
170552	72
170553	72
170554	72
10349B	48
10351B	48
10718B	19
99104L	19
99104M	19
99104XL	19
99104XXL	19
A6046	46
A6047	46
A6132	27
B20010	26
B20011	26
B20123-1	26
B20151	29
B20322	29
B20330	57
B20333	68
B20334	68
B20340	29
B20341	29
B21004	57
B21005	57
B21010	26
B21027	64
B21051	45
B21075	63
B21076	63
B21077	63
B21078	63
B21079	64
B21121	68
B21122	68
B21129	68
B21130	68
B21510	63
B24033	57
B24034	57
B24035	10
C4006	61
C4007	60
C4007-1	60
C4027	61
C5036-3	33
C545504-2	54
CBL7101LED-L	9

ITEM #	PAGE #
CBL7101LED-R	9
CBL7201LED-L	9
CBL7201LED-R	9
CTL7101LED-L	9
CTL7101LED-R	9
CTL7201LED-L	9
CTL7201LED-R	9
F3201LED	64
F5101	20
F5103	20
F646601	5



**ANF1218**  
ANTIQUÉ NEW ITEM SUPPLEMENT  
2018 NEW ITEMS PRODUCT



**710270058648**

**UPauto.com | T 866.327.5288 | F 888.986.6088**

© 2019 United Pacific Industries. All Rights Reserved. Products not shown to scale. Specifications subject to change without notice.