



2017 ANTIQUE NEW ITEM PRODUCT COLLECTION
UNITED PACIFIC INDUSTRIES



Get your parts. Build your passion.

MISSION STATEMENT

Here at United Pacific, we are dedicated to providing today's drivers with innovative and exciting products that deliver exceptional performance and value. Because United Pacific's continuing success depends on our customer's satisfaction, we constantly push our designers and engineers to upgrade our facilities and processes in order to bring products of superior quality and reliability to the market. We at United Pacific promise to continue our passionate pursuit to be the first in Quality, Innovation and Design.

QUALITY

With over 30 years of experience in the automotive aftermarket industry, United Pacific Industries understands the rigors and stresses that our products are subjected to on the road. It is our mission to provide our customers with products of superior quality and reliability. In achieving this goal, United Pacific only partners with manufacturing facilities that conforms to our quality control requirements and standards. Our manufacturing partners meet or exceed ISO-9001 requirements. In addition, United Pacific's manufacturing partners must be equipped on site to perform the following quality assurance tests and maintain a track record of consistent quality and low product failure rate.

- Aging Test
- Air Tight Test
- Dust Test
- Flux Test
- Photometric Test
- Pull Force Test
- Rain Test
- Salt Spray Test
- Shock Test
- Temperature Test
- Humidity Test
- Vibration Test

Furthermore, our internal quality control structure allows us to function as the final quality control station prior to shipping. With the assistance of 3D computer technology, United Pacific can adhere to strict quality control standards during prototype creation and the production process. Our engineers and technicians perform a battery of tests to ensure that our products meet the demands of today's drivers and our goal to be first in quality.

INNOVATION

Known as the leader in innovation, United Pacific is dedicated to be the first to bring new and exciting products to the market. United Pacific's global expertise allows us to search the globe for new ideas and concepts. Not only do we search the globe for new products, United Pacific invest a significant amount of resources into our own research and development efforts. With the assistance of advance 3D scanning technology, our engineers and designers can acquire accurate and precise data in seconds. The 3D data allows United Pacific to verify designs, perform quality assurance tests, and reverse engineer with unprecedented speed and accuracy. Digital inspection contributes to the early detection of shape problems, provides rapid feedback on design, and eliminates unnecessary work in downstream processes. Our rapid prototyping facility permits us to have a concept-to-shelf time of less than 5 months. In addition, United Pacific's 3D printing capabilities permit our designers to have physical models of their design concepts in hours. The physical models allow our designers and marketing staff to evaluate and test the viability of different design ideas. Our rapid prototyping facility allow United Pacific to compress design cycles, improve manufacturing planning, shorten concept-to-shelf time, most importantly, generate new and innovative products.

DESIGN

Located near some of the nation's most progressive automotive design centers, United Pacific established the UP Design Studio in 2002 to consolidate our position as the design leader in the automotive industry. UP Design Studio utilizes the latest generation of computer aided design (CAD) and studio/graphic software. The design studio is equipped with the newest computers and rapid prototyping systems. In addition, UP Design Studio is staffed by graduates from the nation's most prestigious design colleges. Unlike our competitors, United Pacific's design and manufacturing capabilities mean that we carry more new and original items than our competitors. The establishment of the design studio will enable us to generate even more new products with significant shorter concept-to-shelf time. The reduction in development cost mean that we can develop products utilizing design based development processes. Design based product development allows United Pacific to create new product concepts based on designs incorporating driver demands and needs instead of economic considerations. United Pacific's emphasis on design distinguishes and positions us ahead of our competitors.



HOW TO ORDER

To order from United Pacific Industries, you must be an authorized dealer, distributor or OEM. If you are not authorized to stock and sell United Pacific products, you must order through an authorized dealer. Please call 866.327.5288 for more information.

CONTACT US

 8 am - 4:30 pm PST

 866.327.5288 / 562.425.5588

 888.986.6088 / 562.425.3632

 antique@upauto.com

 UPauto.com

 3788 E. Conant St., Long Beach, CA 90808



WARRANTY

With LED (Light Emitting Diodes) rated at 100,000 hours of operation and solid-state construction, United Pacific's LED lights are extremely reliable and durable. Purchase with confidence, United Pacific offers a complete line of LED lighting products with extended or limited lifetime warranties. Please see the warranty policy page for more details.

INVENTORY AND SHIPPING

United Pacific carries over 20,000 items in our California distribution center. No other company in the heavy duty trucking industry can match United Pacific in the variety and range of in-stock inventories. With an order fill rate of over 98.5%, United Pacific is the largest and most reliable supplier in the industry. Our shipping department ships 96.8% of all orders within 24 hours and 98.9% within 48 hours. United Pacific's vast inventory and prompt shipping has made United Pacific the only source for our customer's chrome and lighting needs.



HARD AT WORK FOR THE ENVIRONMENT



United Pacific
132,000 sq ft

Distribution Center
Long Beach, CA

100%

reduction in potable water used for landscaping

40%

reduction in total energy use due to high-efficiency mechanical and lighting systems

82%

of construction waste was diverted from landfills

LEED ACCOMPLISHMENTS

Sustainable Sites

- On-site bicycle storage, showers and changing areas for company employees.
- Preferred parking for low-emitting, fuel-efficient and carpool vehicles.
- Stormwater is infiltrated on-site and treated to remove contaminants to reduce environmental impact on local waterways.

Water Efficiency

- In addition to using reclaimed water, drought-tolerant plants and a high-efficiency irrigation system were installed to reduce the use of potable water for irrigation by 100%.

Energy and Atmosphere

- Efficient HVAC equipment and a lighting system with daylight controls reduces energy consumption by over 30%.
- Enhanced commission verifies that the building's energy and water-related systems are performing as intended by the initial design.

Indoor Environmental Quality

- Building ventilation systems was designed to provide enhanced levels of fresh outside air to building occupants.
- Interior finishes (plants, sealants, adhesives, coatings, carpet systems and composite wood) were selected with low levels of volatile organic compounds (VOCs) to reduce indoor air contamination.



TABLE OF CONTENTS

NEW ITEM SUPPLEMENT

JAN	January 2017	1
FEB	February 2017	9
MAR	March 2017	17
APR	April 2017	21
MAY	May 2017	23
JUN	June 2017	27
JUL	July 2017	31
AUG	August 2017	34
SEP	September 2017	36
OCT	October 2017	44
NOV	November 2017	48
DEC	December 2017	52



1964 1/2 - 1966 Ford Mustang LED Sequential Tail Light

DESCRIPTION

- 68 Super Bright Red LEDs, Complete with Polycarbonate Lens
- Features Sequential Operation with Selector Switch to Select Sequential Left, Sequential Right, or Sequential Function OFF
- Features Sequential-Once Brake Attention Function
- Epoxy Coated, Fully Sealed Electronics, 1157 Plug
- Solid State Circuit Boards are Designed for 7.7-14.0 VDC, **Lifetime Warranty**
- Recommended to Upgrade Under Dash Flasher to 90652 LED Flasher



Item #	Description	Package	Pack
110105	1964 1/2 - 66 Mustang, Fits L/H & R/H	Carded	1 Pc./Card

1969 Ford Mustang LED Sequential Tail Light

DESCRIPTION

- 108 Super Bright LEDs, Complete with Polycarbonate Lens
- Features Sequential Operation with Selector Switch to Select Sequential Left, Sequential Right, or Sequential Function OFF
- Features Sequential-Once Brake Attention Function
- Epoxy Coated, Fully Sealed Electronics, 1157 Plug
- Solid State Circuit Boards are Designed for 7.7-14.0 VDC
- Includes Polished Stainless Steel Trim Ring Attached, **Lifetime Warranty**
- Recommended to Upgrade Under Dash Flasher to 90652 LED Flasher

Item #	Description	Package	Pack
110107	1969 Mustang, Fits L/H & R/H	Carded	1 Pc./Card

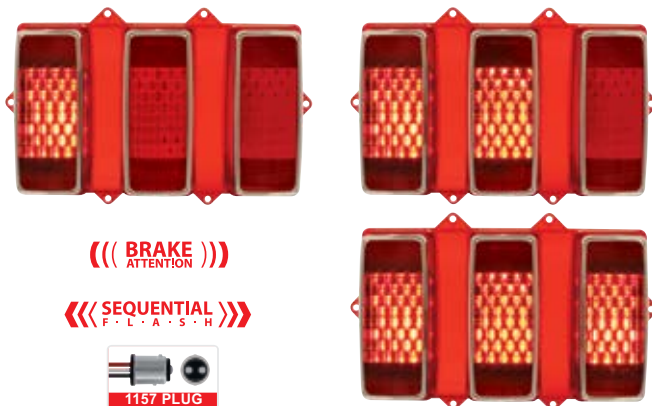

1969 Chevy Camaro LED Sequential Tail Light

DESCRIPTION

- 84 Super Bright LEDs, Complete with Polycarbonate Lens
- Features Sequential Operation with Selector Switch to Select Sequential Left, Sequential Right, or Sequential Function OFF
- Features Sequential-Once Brake Attention Function
- Epoxy Coated, Fully Sealed Electronics, 1157 Plug
- Solid State Circuit Boards are Designed for 7.7-14.0 VDC
- Includes Polished Stainless Steel Trim Ring Attached, **Lifetime Warranty**
- Recommended to Upgrade Under Dash Flasher to 90652 LED Flasher

Item #	Description	Package	Pack
110108	1969 Camaro L/H	Carded	1 Pc./Card
110109	1969 Camaro R/H	Carded	1 Pc./Card





NEW!

Oval Aluminum Air Cleaner

DESCRIPTION

- Complete Assembly with Top, Base & Air Filter Element
- Measures 21" Long, 10" Wide, 2-1/4" Tall (2-3/8" Tall at Carb Flange)
- Includes Die Cast Chrome Plated 3-Wing Nut & Mounting Hardware

Item #	Description	Package	Pack
110290	Single 4-Barrel Carburetor	Boxed	1 Pc./Box
110291	Dual 4-Barrel Carburetor	Boxed	1 Pc./Box

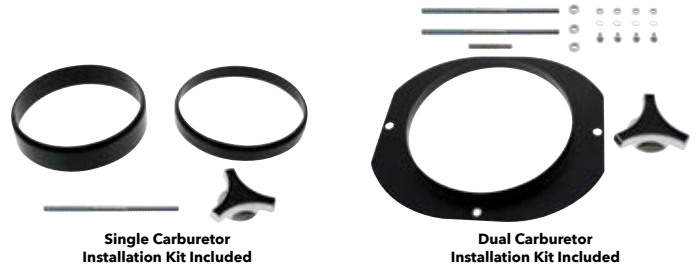

Single Carburetor Installation Kit Included

Dual Carburetor Installation Kit Included

1932-35 Ford Passenger Car & 1932 Truck Hood Retainers

NEW!

DESCRIPTION

- Polished Stainless Steel
- Front Retainer B20355 Also Fits 1933-36 Passenger Car Rear
- Includes Mounting Hardware

Item #	Description	Package	Pack
B20355	Front Hood Retainer	Carded	1 Set/Card
B20356	Rear Hood Retainer	Carded	1 Set/Card



B20356

1932-34 Ford Truck

NEW!

Inside Door Handle Shaft Remote Relay Triangle Set

DESCRIPTION

- Use to Repair Worn Out Inside Door Handle Shaft
- Includes Rivet & Spring Washer for Installation
- Sold in Pairs

Item #	Description	Package	Pack
B21012-TPS	32-34 Truck Door Relay Set	Bulk	1 Set/Bag

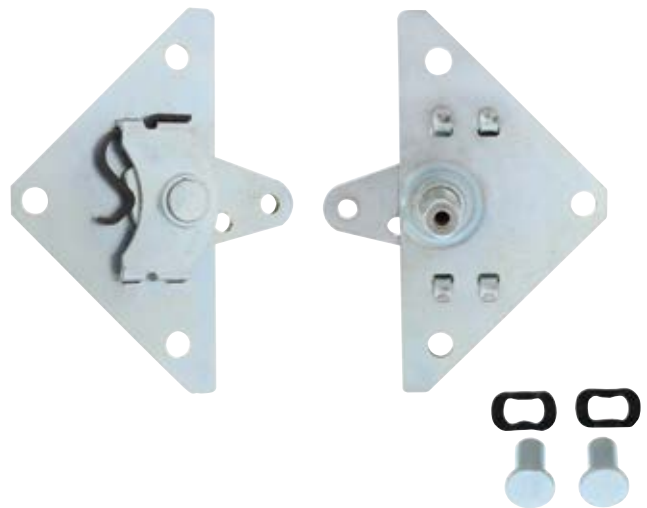

1937-40 Ford Passenger Car Original Style Transmission Cover



DESCRIPTION

- Heavy Stamped Steel As Original
- Also Fits 1937-39 with Modification for Shifter Hole
- Designed for Bolt-On Installation & Coated in Weldable Primer

Item #	Description	Package	Pack
110322	Transmission Cover	Boxed	1 Pc./Box



1939 Ford Coupe, Convertible, Sedan Rear Fender



DESCRIPTION

- Heavy Gauge Stamped Steel As Original
- Also Fits 1938 Deluxe Sedan
- With Original Tail Lamp Mounting Hole
- Lefthand Fender Has Original Gas Filler Neck Hole
- Coated in Weldable Primer
- Sold Individually, Please Specify Driver or Passenger Side

Item #	Description	Package	Pack
110323	39 Ford, L/H	Boxed	1 Pc./Box
110324	39 Ford, R/H	Boxed	1 Pc./Box



1937-40 Ford Passenger Car Universal Transmission Cover Set



DESCRIPTION

- Perfect Choice for Firewalls with Setback
- Includes Toe Board Extensions
- Designed for Bolt-On Installation & Coated in Weldable Primer

Item #	Description	Package	Pack
110321	Universal Trans Cover Set	Boxed	1 Set/Box



1940 Ford Coupe, Convertible, Sedan Rear Fender



DESCRIPTION

- Heavy Gauge Stamped Steel As Original
- With Original Tail Lamp Mounting Hole
- Lefthand Fender Has Original Gas Filler Neck Hole
- Coated in Weldable Primer
- Sold Individually, Please Specify Driver or Passenger Side

Item #	Description	Package	Pack
110325	40 Ford, L/H	Boxed	1 Pc./Box
110326	40 Ford, R/H	Boxed	1 Pc./Box



1939-40 Ford Regular Coupe Middle Floor Pan



DESCRIPTION

- Heavy Stamped Steel As Original
- The Middle Floor is Also Known As the Package Tray Floor
- Also Used to Modify A Business Coupe Into A Regular Coupe (Deletes Jump Seats)
- Coated in Weldable Primer

Item #	Description	Package	Pack
110229	Middle Floor Pan	Boxed	1 Pc./Box



1939-40 Ford Coupe Trunk Floor with Pocket Covers



DESCRIPTION

- Heavy Stamped Steel As Original
- Trim to Fit Convertible and Business Coupe
- Includes L/H & R/H Rear Pocket Covers
- Coated in Weldable Primer

Item #	Description	Package	Pack
110230	Trunk Floor	Boxed	1 Pc./Box



1966-77 Ford Bronco Inner Rear Wheelhouse



DESCRIPTION

- Heavy Gauge Stamped Sheet Metal As Original
- Coated in Weldable Primer
- Sold Individually, Please Specify Driver or Passenger Side

Item #	Description	Package	Pack
110277	66-77 Bronco, L/H	Bulk	1 Pc.
110278	66-77 Bronco, R/H	Bulk	1 Pc.



1966-77 Ford Bronco Tail Light Housing Corner Panel



DESCRIPTION

- Heavy Gauge Stamped Sheet Metal As Original
- Coated in Weldable Primer
- Sold Individually, Please Specify Driver or Passenger Side

Item #	Description	Package	Pack
110271	66-77 Bronco, L/H	Boxed	1 Pc./Box
110272	66-77 Bronco, R/H	Boxed	1 Pc./Box



110371

110372

1966-67 Ford Bronco Floor Pan Brace



DESCRIPTION

- Heavy Gauge Stamped Sheet Metal As Original
- Coated in Weldable Primer
- Sold Individually, Please Specify Front, Center or Rear

Item #	Description	Package	Pack
110235	Center Floor Pan Brace	Bulk	1 Pc.
110236	Front Floor Pan Brace	Bulk	1 Pc.
110237	Rear Floor Pan Brace	Bulk	1 Pc.



1966-67 Ford Bronco Floor Pan Support Braces



DESCRIPTION

- Heavy Gauge Stamped Sheet Metal As Original
- Coated in Weldable Primer
- Sold In Sets, Please Specify Front or Rear Set

Item #	Description	Package	Pack
110242	Front Floor Pan Brace	Boxed	1 Pair/Box
110238	Rear Floor Pan Brace	Boxed	1 Pair/Box



1966-77 Ford Bronco Outer Cowl Side Panel



DESCRIPTION

- Heavy Gauge Stamped Sheet Metal As Original
- Coated in Weldable Primer
- Sold Individually, Please Specify Driver or Passenger Side

Item #	Description	Package	Pack
110240	66-77 Bronco, L/H	Bulk	1 Pc.
110241	66-77 Bronco, R/H	Bulk	1 Pc.

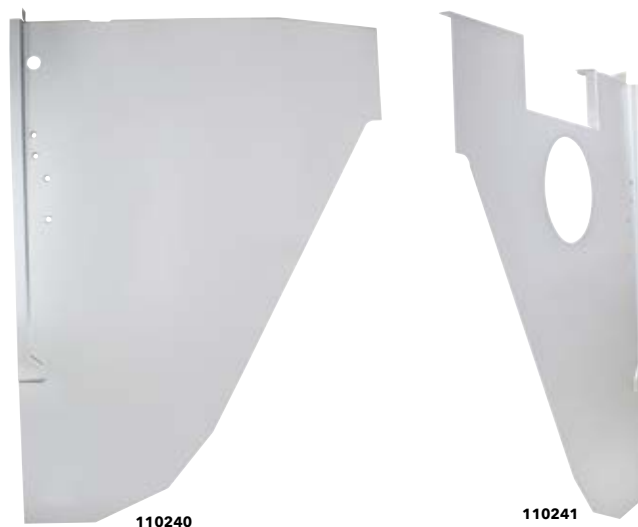

1966-77 Ford Bronco Wheelhouse Filler Plates



DESCRIPTION

- Heavy Gauge Stamped Sheet Metal As Original
- Modification Required for Installation on 1977 Bronco
- Coated in Weldable Primer
- Sold In Sets, Please Specify Driver or Passenger Side

Item #	Description	Package	Pack
110275	66-77 Bronco, L/H	Boxed	1 Set/Box
110276	66-77 Bronco, R/H	Boxed	1 Set/Box



NEW!

1967-72 Chevy & GMC Truck Lower Glass Channel

DESCRIPTION

- High Tensile Strength Steel Just Like Original
- Sold Individually, Please Specify Driver or Passenger Side

Item #	Description	Package	Pack
110244	67-72 Chevy & GMC Truck, R/H	Boxed	1 Pc./Box
110245	67-72 Chevy & GMC Truck, L/H	Boxed	1 Pc./Box



NEW!

1947-54 Chevy & GMC Truck Headlight Bucket

DESCRIPTION

- Stamped Steel As Original
- Includes Inner Headlamp Cradle and Aiming Adjusters and Springs
- Includes Chrome Headlamp Retainer Ring and Screws
- Includes Headlamp Wiring Pigtail with Ring Terminals As Original
- Fits Lefthand and Righthand

Item #	Description	Package	Pack
110282	Headlight Bucket	Boxed	1 Pc./Box

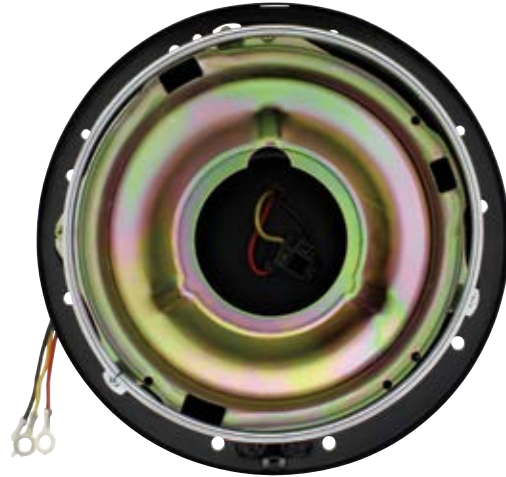

1960-66 Chevy & GMC Truck Wiper Tower & Linkage Set

DESCRIPTION

- Complete Wiper Linkage Set with Die Cast Wiper Shaft Towers, Pivots, and Link Arms
- Sold As a Set

Item #	Description	Package	Pack
110243	Wiper Tower & Linkage Set	Boxed	1 Set/Box

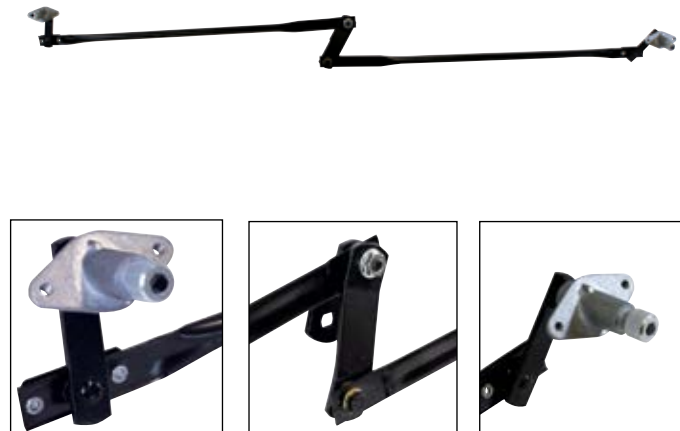

NEW!

1947-54 Chevy & GMC Truck Hood Safety Catch

DESCRIPTION

- Die Stamped Steel & Spring Loaded As Original
- Black EDP Coated
- Also Fits 1955 1sr Series

Item #	Description	Package	Pack
110279	Hood Safety Catch	Boxed	1 Pc./Box



NEW!

1964 1/2-1966 Ford Mustang Front Floor Crossmember



DESCRIPTION

- Heavy Stamped Steel As Original
- Has Welded-In Spacers For Trans Support Bolts
- Black EDP Coated

Item #	Description	Package	Pack
110286	Front Floor Crossmember	Bulk	1 Pc.



1967-72 Chevy & GMC Truck Pickup Bed to Frame Bolt Set



DESCRIPTION

- Special Carriage Bolts That Mount the Pickup Bed to The Frame
- Includes Flat Washers, Lock Washers and Hex Nuts
- Zinc Plated As Original
- Sold in Set

Item #	Description	Package	Pack
110248	Pickup Bed to Frame Bolt Set	Boxed	1 Set/Box

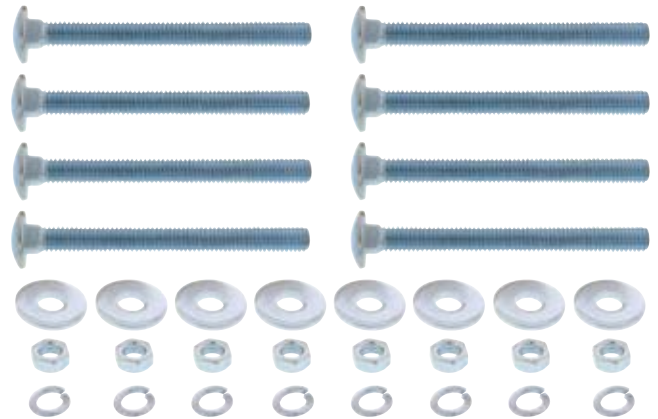

1969-71 Chevy Camaro Front "SS" Emblem



DESCRIPTION

- For Super Sport Camaro without RS Package
- Includes Backing Plate and Nuts
- GM Restoration Parts Licensed

Item #	Description	OEM Number	Pack
110129	"SS" Emblem	3981921	1 Pc./Box



6 High Power LED Driving/Work Light



DESCRIPTION

- 6 High Power 3 Watt LED Work Light, Competition Series
- 10V-30V Application, 1260 Lumens, 3 Years Warranty

Item #	Description	Package	Pack
36522	6 LED Spot Light	Color Box	1 Pc./Box
36523	6 LED Flood Light	Color Box	1 Pc./Box



High Power Dixie Air Horn

DESCRIPTION

- Plays Dixie Tune As Used on the Famous Dodge Charger TV & Movie Cars
- Old School Mechanical Air Powered Just Like Back In the Day (Not Electronic)
- Package Includes 5 Chrome ABS Trumpets, Air Compressor, Air Tubing, Mounting Hardware and Instructions

Item #	Description	Package	Pack
46153	Dixie Air Horn	Carded	1 Set/Card

126dB



NEW!

1 LED Snap-In Indicator Light

DESCRIPTION

- Snap-In Indicator Light with 1 Super Bright LED
- Requires 1/4" Diameter Hole for Installation
- Wire Length Approximately 7", **Lifetime Warranty**

Item #	LEDs	Lens	Package	Pack
36517B	1 Amber	Amber	Bulk	1 Pc.
36518B	1 Blue	Clear	Bulk	1 Pc.
36519B	1 Green	Green	Bulk	1 Pc.
36520B	1 Red	Red	Bulk	1 Pc.
36521B	1 White	Clear	Bulk	1 Pc.



NEW!

High Power 9005/HB3 LED Headlamp Bulb

DESCRIPTION

- 2 CREE High Power White LED
- 10W Low Beam Application, Bright 1200 Lumen Output, 6000K
- Fanless Design, Proprietary Heat Sink Dissipates Excess Heat

Item #	LEDs	Bulb Type	Package	Pack
36888	2	9005/HB3	Carded	1 Pc./Card



NEW!

Chrome Skull Accent

DESCRIPTION

- Chrome Plastic Skull Accent
- Approximately 7 1/4" L x 2 1/2" W x 1 1/4" H, Double Sided Tape Mount

Item #	Description	Package	Pack
50112	Skull Accent	Carded	1 Pc./Card



NEW!



NEW ITEMS

FEBRUARY 2017



1932-34 Ford Truck Door Shell

DESCRIPTION

- The Wait Is Over! Every Detail Exactly As Original, Looks Like NOS.
- Complete Outer Skin and Inner Structure Hemmed Together As Original
- Both Doors Have Door Handle Holes, and Lock Cylinder Hole on Right Hand Door
- Door Latch, Door Hinges and Removable Window Guide Channel and Cover Plates Sold Separately
- Black EDP Coated. Packed in Strong Box for Easy Shipping

Go to UPauto.com to See All 1932-34 Ford Truck Parts

Item #	Description	Package	Pack
B21015	32-34 Truck, L/H	Boxed	1 Pc./Box
B21016	32-34 Truck, R/H	Boxed	1 Pc./Box



C5059 - 16"

C5055 - 15"

C5056 - 14"



Chrome Polara Tri-Bar Hubcap Set

DESCRIPTION

- Styling From the Futuristic Early 60's Polara Hubcap
- Die Cast Chrome Plated Tri-Bar Rocket Center Bullet
- Super Detailed Jet Turbine Inspired Chrome Hubcap with White Painted Insets
- Sold in Sets of 4

Item #	Description	Package	Pack
C5059	16" Polara Tri-Bar Caps	Boxed	4 Pcs./Box
C5055	15" Polara Tri-Bar Caps	Boxed	4 Pcs./Box
C5056	14" Polara Tri-Bar Caps	Boxed	4 Pcs./Box

NEW!

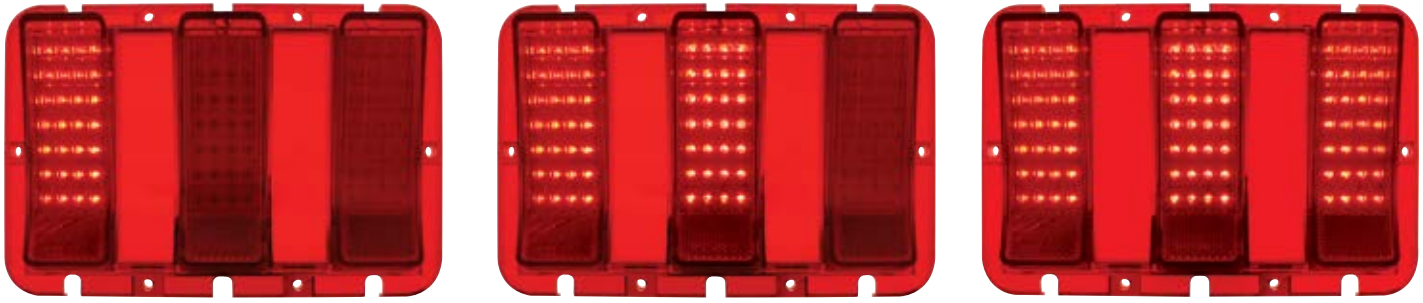

1967-68 Ford Mustang LED Tail Light

DESCRIPTION

- 84 Super Bright Red LEDs, Complete with Polycarbonate Lens
- Features Sequential Operation with Selector Switch to Select Sequential Left, Sequential Right, or Sequential Function OFF
- Features Sequential-Once Brake Attention Function
- Epoxy Coated, Fully Sealed Electronics, 1157 Plug
- Solid State Circuit Boards are Designed for 7.7-14.0 VDC, **Lifetime Warranty**
- Recommended to Upgrade Under Dash Flasher to 90652 LED Flasher

Item #	Description	Package	Pack
110106	Sequential LED, Fits L/H & R/H	Carded	1 Pc./Card

Chrome Bezel Sold Separately



F67804 - 1967

F67805 - 1968



1157 PLUG



1964 1/2-66 Ford Mustang Convertible Full Quarter Panel

NEW!

DESCRIPTION

- Excellent Steel Reproduction of the Full Quarter Panel with All of the Original Contour Detail
- Fits 1964 1/2-66 Ford Mustangs
- Black EDP Coated Finish
- Has Side Trunk Drain Channel Groove

Item #	Application	OEM Number	Pack
110391	Righthand	C5ZZ-7627846-B	1 Pc./Box
110392	Lefthand	C5ZZ-7627847-B	1 Pc./Box



1964 1/2-66 Ford Mustang Front Valance

NEW!

DESCRIPTION

- Excellent Stamped Steel Reproduction of the Front Valance with All of the Original Contour Detail
- Fits 1964 1/2-66 Ford Mustangs
- Has the Identical Parking Light Opening, and License Plate Recess as the Original
- Black EDP Coated Finish

Item #	Finish	OEM Number	Pack
110287	Black	C5ZZ-17A939-A	Bulk=1 Pc.



1967-68 Ford Mustang Front Valance



DESCRIPTION

- Excellent Stamped Steel Reproduction of the Front Valance with All of the Original Contour Detail
- Fits 1967-68 Ford Mustangs
- Has the Identical Parking Light Opening, and License Plate Recess as the Original
- Black EDP Coated Finish

Item #	Finish	OEM Number	Pack
110288	Black	C7ZZ-17A939-A	Bulk=1 Pc.



1968-77 Ford Bronco Inner Rocker Panel



DESCRIPTION

- Excellent Reproduction of the Original Inner Rocker Panel with All Contour Detail
- Fits 1968-77 Ford Broncos
- Made with 18 Gauge Steel Coated in Weldable Primer
- Sold Individually, Please Specify Driver or Passenger Side

Item #	Application	OEM Number	Pack
110269	Lefthand	C6TZ-16505-A	Bulk=1 Pc.
110270	Righthand	C6TZ-16506-A	Bulk=1 Pc.

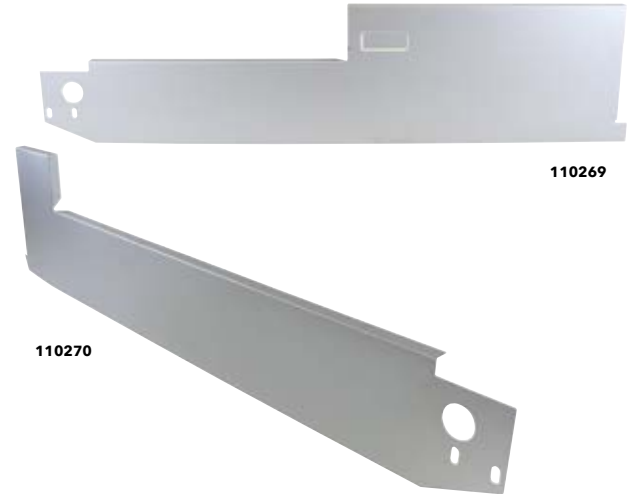

1957 Chevy Truck Chrome Grille



DESCRIPTION

- Excellent Steel Reproduction of the Original Truck Grill
- Fits 1957 Chevy Trucks
- Beautifully Chrome Plated with Triple Plating Process

Item #	Description	Package	Pack
110389	57 Chevy Truck Grill	Boxed	1 Pc./Box



1947-54 Chevy Truck Chrome Hood Latch Panel



DESCRIPTION

- Excellent Stamped Steel Reproduction of the Hood Latch Panel with All of the Original Contour Detail
- Fits 1947-54 Chevy Trucks
- Beautifully Chrome Plated with Triple Plating Process
- Has Radiator, Fender, and Grille Bar Mounting Bolt Holes
- Has Pre-Installed Hood Latch

Item #	Description	Package	Pack
110340	Hood Latch Panel	Boxed	1 Pc./Box



1947-55 Chevy & GMC 1st Series Truck Hood Hinge And Support

NEW!

DESCRIPTION

- Heavy Duty Steel Reproduction of the Original Hood Hinge Style and Design
- Fits 1947-55 Chevy & GMC 1st Series Trucks
- Includes Hood Support Arm with Clock Spring
- Black EDP Coated Finish
- Sold Individually, Please Specify Driver or Passenger Side

Item #	Description	Package	Pack
110249	47-55 Chevy & GMC, L/H	Boxed	1 Pc./Box
110250	47-55 Chevy & GMC, R/H	Boxed	1 Pc./Box



1958-59 Chevy Truck Hood Latch Panel

NEW!

DESCRIPTION

- Excellent Stamped Steel Reproduction of the Hood Latch Panel with All of the Original Contour Detail
- Fits 1958-59 Chevrolet Trucks
- Has Radiator, Fender, and Grille Bar Mounting Bolt Holes
- Black EDP Coated Finish

Item #	Description	Package	Pack
110342	Hood Latch Panel	Bulk	1 Pc.



1967-72 Chevy & GMC Truck Fleetside LED Tail Light Assembly

DESCRIPTION

- 20 Super Bright Red LEDs, Complete with Polycarbonate Lens
- Includes Steel Trail Light Housing with Socket and Gasket
- Available with Standard LED or Sequential Operation with Selector Switch to Select Sequential Left, Sequential Right, or Sequential Function OFF
- Features Sequential-Once Brake Attention Function
- Epoxy Coated, Fully Sealed Electronics, 1157 Plug
- Solid State Circuit Boards are Designed for 7.7-14.0 VDC, **Lifetime Warranty**
- Recommended to Upgrade Under Dash Flasher to 90652 LED Flasher



SEQUENTIAL
F · L · A · S · H

BRAKE
ATTENTION

Item #	Description	Package	Pack
110213	Standard LED, Fits L/H & R/H	Color Box	1 Pc./Box
110214	Sequential LED, Fits L/H & R/H	Color Box	1 Pc./Box

1967-72 Chevy & GMC Truck Door Latch with Relay and Lock Rods



DESCRIPTION

- High Quality Steel Reproduction of the Original Door Latch and Locking Mechanism
- Fits 1967-72 Chevrolet & GMC Trucks
- Includes One Door Latch, One Relay Rod, and One Lock Rod
- Sold Individually, Please Specify Driver or Passenger Side

Item #	Description	Package	Pack
110246	67-72 Chevy & GMC, R/H	Boxed	1 Pc./Box
110247	67-72 Chevy & GMC, L/H	Boxed	1 Pc./Box

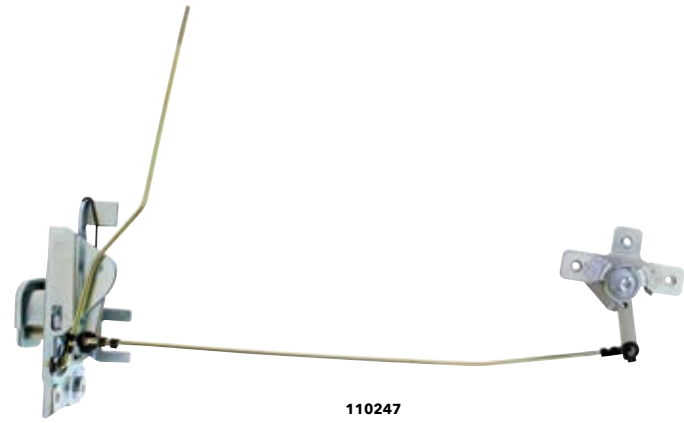

15" Track Style Steering Wheel



DESCRIPTION

- Chrome Plated 4 Spoke Design
- Comfortable Hard Rubber Grip
- Use with 3 Bolt Hub Kits
- Hub Adaptor and Horn Button Kit Sold Separately

Item #	Description	Package	Pack
110124	15" Track Style Steering Wheel	Color Box	1 Pc./Box



Foliage Camo License Frame



DESCRIPTION

- High Quality Camouflage Printing on Metal License Frame
- Universal Design, Perfect for Cars, Trucks, and Pickups

Item #	Description	Package	Pack
50047	Foliage Camo License Frame	Carded	1 Pc./Card



Motorcycle Rubber Grip Set



DESCRIPTION

- High Quality Molded Rubber Provides Comfortable Grip
- Old School Dirt Track Look in 4 Colors, Sold in Pairs
- Available for 7/8" or 1" Handlebar, Twist Grip Side has Larger ID

Item #	Size	Color	Pack
52000B	1"/1-1/8" (25/28mm)	Black	1 Pair/Color Box
52001B	1"/1-1/8" (25/28mm)	Red	1 Pair/Color Box
52002B	1"/1-1/8" (25/28mm)	White	1 Pair/Color Box
52003B	1"/1-1/8" (25/28mm)	Natural	1 Pair/Color Box
52004B	7/8"/1" (22/25mm)	Black	1 Pair/Color Box
52005B	7/8"/1" (22/25mm)	Red	1 Pair/Color Box
52006B	7/8"/1" (22/25mm)	White	1 Pair/Color Box
52007B	7/8"/1" (22/25mm)	Natural	1 Pair/Color Box



Color Retail Packaging

HOT!



High Power Double Row LED Light Bar

DESCRIPTION

- 3W High Power "Cree" LED, Double Row LED light Bar
- 12V - 24V Application
- Manufactured with USA Made "Cree" LEDs
- 3 1/8" Tall x 3 1/2" Wide, Light is 4 3/4" Tall with Mounting Bracket
- Available in 3 Different Lengths, Heavy Duty Aluminum Housing, **3 Year Warranty**

Item #	LEDs	Lumens	Length	Pack
36781	12	2640 lm	7 1/2"	1 Pc./Box
36782	24	5280 lm	13 1/2"	1 Pc./Box
36783	40	8800 lm	21 1/2"	1 Pc./Box



Manufactured with USA Made
CREE LEDs

MULTIPLE
12V - 24V
VOLTAGE

IP 67
Rated



NEW!

6" x 4" Rectangular LED Crystal Headlight with 6 Dual Function Amber LED Position Lights

DESCRIPTION

- 6" x 4" Rectangular Crystal Headlights with 1 High Power LED and 6 Dual Function Amber LED Position Lights
- Available in Low Beam or High Beam Modules Only
- Solid State Design Resists Shock and Vibration
- Impact Resistant Polycarbonate Lens Provides Unparalleled Protection from Road Hazards
- Improves Visibility with Whiter Light Output that is Closer to Daylight
- Die-Cast Aluminum Housing Provides Maximum Protection from the Elements
- Load Resistor May be Required for Proper Installation
- SAE/DOT FMVSS108
- For Off-Road Use Only, **3 Years Warranty**

Technical Specification	
Low Beam Application 12 - 24V DC Input 0.35 Amps / 8.5 Watt FMVSS 108	High Beam Application 12 - 24V DC Input 0.6 Amps / 14.5 Watt FMVSS 108

Item #	Description	Package	Pack
31237	Low Beam	Color Box	1 Pc./Box
31238	High Beam	Color Box	1 Pc./Box

LED Headlight PWM Anti Flicker Module & Adaptor



DESCRIPTION

- Works With Most Vehicles Using Pulse Width Modulated Electrical System, Such as 2007-Present Jeep JK
- Eliminates Flicker on LED Headlamps
- Adapts Common H13 Plug to H4 Plug Used by Most LED Headlights

Item #	Description	Package	Pack
34217B	Anti Flicker Adaptor	Bulk	1 Pc.

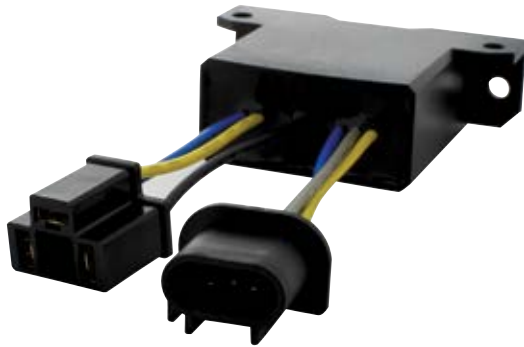

9 LED Square Wide Angle Driving/Work Light



DESCRIPTION

- 9 LED Square Wide Angle Work Light
- 12V-36V Application, 2160 Lumens, 3 Years Warranty

Item #	Description	Package	Pack
36514	9 LED Flood Light	Carded	1 Pc./Card
36514B	9 LED Flood Light	Bulk	1 Pc.



3 LED Dual Color Mini Clearance/Marker Light



DESCRIPTION

- 3 LED Dual Color Mini Clearance/Marker Light with Stainless Steel Bezel
- Requires a 3/4" Opening, 3 Wire Hardwired, Rubber Grommet Included

Item #	Primary LED	Secondary LED	Lens	Pack
36838	Amber	Red	Clear	1 Pc./Card
36839	Amber	White	Clear	1 Pc./Card
36840	Amber	Blue	Clear	1 Pc./Card
36841	Red	White	Clear	1 Pc./Card
36842	Red	Blue	Clear	1 Pc./Card

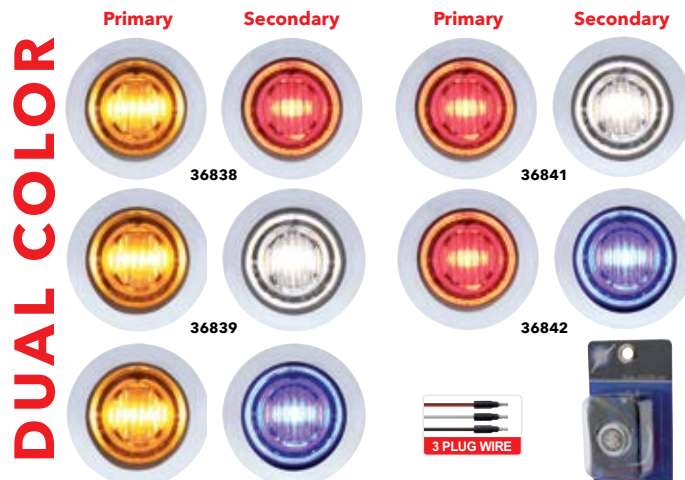

8 LED Oval Wide Angle Driving/Work Light



DESCRIPTION

- 8 LED Oval Wide Angle Work Light
- 12V-36V Application, 1920 Lumens, 3 Years Warranty

Item #	Description	Package	Pack
36515	8 LED Flood Light	Carded	1 Pc./Card
36515B	8 LED Flood Light	Bulk	1 Pc.



NEW!

Ratchet Tie Down - S Hook

DESCRIPTION

- Heavy Duty Ratchet Tie Down
- Zinc Plated S Hook
- Rubberized Cover Handle for Added Comfort and Grip

Item #	Description	Break Strength	Load Limits	Pack
90809	1"x15'TieDown	1,500 lbs	500 lbs.	1 Pc./Retail Pack
90810	1"x15'TieDown	1,500 lbs	500 lbs.	4 Pcs./Retail Pack



S Hook

HOT!

Ratchet Tie Down - J Hook

DESCRIPTION

- Heavy Duty Ratchet Tie Down
- Zinc Plated Double J Hook
- Rubberized Cover Handle for Added Comfort and Grip for Item #: 90800 and 90801

Item #	Description	Break Strength	Load Limits	Pack
90800	15"x15'TieDown	6,600 lbs	2,200 lbs.	1 Pc./Retail Pack
90801	2"x27'TieDown	10,000 lbs	3,333 lbs.	1 Pc./Retail Pack
90802	3"x27'TieDown	15,000 lbs	5,000 lbs.	1 Pc./ Bulk
90803	4"x30'TieDown	16,200 lbs	5,400 lbs.	1 Pc./ Bulk

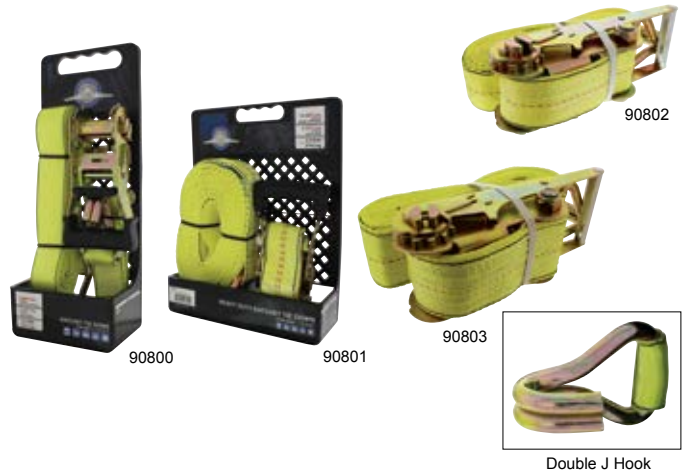

Double J Hook

Ratchet Tie Down - Flat Hook

DESCRIPTION

- Heavy Duty Ratchet Tie Down
- Zinc Plated Flat Hook

Item #	Description	Break Strength	Load Limits	Pack
90808	4"x30'TieDown	16,200 lbs	5,400Lbs	1 Pc./ Bulk

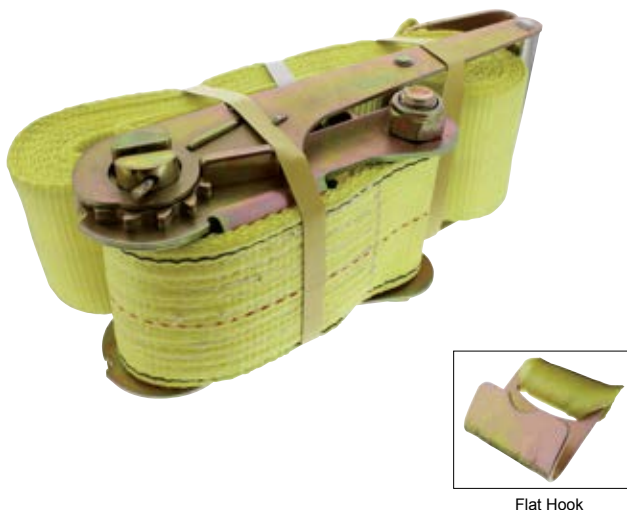

Flat Hook

1932 Ford 5 Window Coupe & 1932-34 Pickup Truck Product Catalog



Available Now!



NEW ITEMS

MARCH 2017

NEW

NEW



Chopper Style
Item # 88303



Scorpion Style
Item # 88304



3 Spoke Style
Item # 88300



Boss Style
Item # 88301



Blade Style
Item # 88302



14" Chrome Aluminum Steering Wheel

DESCRIPTION

- 14" Chrome Aluminum Steering Wheel with Comfortable Black Leatherette Grip
- Requires Standard 9-Screw Steering Wheel Hub Adapter and Horn Button Kit, Sold Separately
- Well Packaged in Attractive Color Box

Item #	Description	Package	Pack
88300	3 Spoke Style	Color Box	1 Pc./Box
88301	Boss Style	Color Box	1 Pc./Box
88302	Blade Style	Color Box	1 Pc./Box
88303	Chopper Style	Color Box	1 Pc./Box
88304	Scorpion Style	Color Box	1 Pc./Box

12 Volt or 6 Volt Chrome Ignition Coil Kit

NEW!

DESCRIPTION

- PERFECT Complement to Your Classic Hot Rod or Any Vehicle Running American Iron Under the Hood Using Universal 12 Volt Ignition Coil!
- Bundle Comes with Everything You'll Need, Including A High Quality 12 Volt or 6 Volt Coil with Chrome Housing, 1.6 Ohm Ceramic Coil Resistor and Chrome Coil Mounting Bracket
- High Quality Chrome Housing Will Match Most of Your Under Hood Chrome Parts, or Stand Out In A Sea of Black Plastic or Oxidized Iron!

Item #	Description	Package	Pack
110436	12V Ignition Coil Kit	Boxed	1 Set/Box
110437	6V Ignition Coil Kit	Boxed	1 Set/Box



Chrome Aluminum Interior Rear View Mirror - Screw-On Mount

NEW!

DESCRIPTION

- Perfect Mirror for Hot Rods, Street Rods
- Easy Installation, Mounts At Any Angle With the Fully Adjustable Mirror Arm Base

Item #	Description	Package	Pack
70803	Rectangular Mirror	Boxed	1 Pc./Box
70804	Oval Mirror	Boxed	1 Pc./Box



NEW!

Interior Mirror Bracket Screw

DESCRIPTION

- Screw Is Used to Mount Mirror Head to Mirror Bracket
- Special Slot Head Shoulder Screw As Original
- Polished Stainless Steel, Sold Each

Item #	Description	Package	Pack
C607112	Mirror Screw	Bulk	1 Pc.



Vehicle Application:

- 1960 - 1971 Chevy & GMC Truck
- 1958 - 1970 Impala
- 1962 - 1972 Nova
- 1964 - 1972 Chevelle
- 1964 - 1972 El Camino
- 1967 - 1969 Camaro
- 1967 - 1969 Firebird
- 1970 - 1972 Monte Carlo
- 1967 - 1970 Buick Riviera
- 1964 - 1972 Buick Skylark
- 1964 - 1972 Olds Cutlass
- 1959 - 1969 Pontiac Catalina
- 1962 - 1972 Pontiac Grand Prix
- 1961 - 1972 Pontiac "A" Body



HOT!

Chrome Aluminum Interior Rear View Mirror - Glue-On Mount

DESCRIPTION

- Perfect Mirror for Hot Rods, Street Rods
- Easy Installation, Simply Glue-On to Windshield Glass
- Recommended Adhesive: Loctite 37438, Permatex 81840, 3M 08752

Item #	Description	Package	Pack
70801	Rectangular Mirror	Boxed	1 Pc./Box
70802	Oval Mirror	Boxed	1 Pc./Box



17 High Power LED 7" Spot/Off Road Light

DESCRIPTION

- 17 High Power 7" Spot/Off-Road Light, Diecast Aluminum Housing
- 10V-30V, 3100 Lumens, **3 Year Warranty**

Item #	LEDs	Lumens	Voltage	Pack
36516	17	3100	10V - 30V	1 Pc./Box



LIGHT 3100 LUMENS
MULTIPLE 10V - 30V VOLTAGE
HIGH POWER 3WATT X 17 LED
IP 67 Rated
2 HARD WIRE



HOT!

High Power Four Row LED Light Bar - Reflector Series

DESCRIPTION

- 1.5W High Power LED, Four Row LED light Bar
- 3 1/8" Tall x 2 1/4" Wide, Light Is 5 1/8" Tall with Mounting Bracket. Includes Mounting Hardware
- 3 Year Warranty Also Available In 41 1/4" (Item # 36650), 51 1/2" (Item # 36651) with Standard Plain Box

Item #	LEDs	Lumens	Length	Pack
36646	24	2160 lm	7 1/4"	1 Pc./Box
36647	48	4320 lm	13 1/4"	1 Pc./Box
36648	80	7200 lm	21 1/4"	1 Pc./Box
36649	120	10800 lm	30 1/2"	1 Pc./Box

Color Retail Packaging



Blue Tiger Elite Premium Bluetooth Headset



DESCRIPTION

- 34 Hours of Talk Time, 600 Hours of Standby Time
- Elite Bluetooth Headset with Hi-Fi Speaker, Bluetooth 4.0
- Multimedia Playback- Listen to Music, Podcasts and More
- Noise-Canceling Technology Allows You to Focus More Easily
- Includes Wall Charger and Car/Truck Cigarette Lighter Charger

Item #	Description	Package	Pack
95000	Matte Black Headset	Boxed	1 Pc./Box
95001	Camo Headset	Boxed	1 Pc./Box



Skull Motorcycle License Frame



DESCRIPTION

- Durable Zinc Diecast Skull Motorcycle License Frame
- Universal Design, Fits All U.S. Motorcycle License Frame

Item #	Description	Finish	Pack
50113	Skull License Frame	Black	1 Pc./Card
50065	Skull License Frame	Chrome	1 Pc./Card



2 - Pack Matte Black Metal License Frame Kit



DESCRIPTION

- Kit Includes 2 License Plate Frames, 4 Screws & 4 Screw Caps
- Durable Matte Black Powder Coated Finish on Metal Die-Cast Wide Bottom License Frames

Item #	Description	Package	Pack
49999	Black License Plate Frames	Carded	1Kit/Card



Matte Black Motorcycle License Frame



DESCRIPTION

- Durable Matte Black Powder Coated Finish on Metal Diecast License Frame

Item #	Description	Package	Pack
50109	Matte Black License Frame	Carded	1 Pc./Card



"8" Ball License Plate Fastener, Item # 70075

NEW!

Chrome Deluxe LED License Plate Frame - Split Turn Function

DESCRIPTION

- 10 LED 9" Split Turn Function Light Bar with Chrome Metal License Plate Frame
- Dual Function with 10 LED Running Light & 5 LED Lefthand & 5 LED Righthand Turn Signal
- Easy Electrical Hookup with 4 Wires: Ground, Tail, L/H High, R/H High
- Includes Stainless Steel Mounting Hardware
- 9" Chrome Plastic Light Bar Bezel Also Available Separately Item # 30932B

Item #	LEDs	Lens	Package	Pack
39397	10 Red	Red	Carded	1 Pc./Card



NEW!

10 LED 9" Split Turn Function Light Bar

DESCRIPTION

- 10 LED 9" Split Turn Function S/T/T Light Bar, 9" L x 5/8" W
- Dual Function with 10 LED Running Light & 5 LED Lefthand & 5 LED Righthand Turn Signal
- Easy Electrical Hookup with 4 Wires: Ground, Tail, L/H High, R/H High
- Mounting Holes Approximately 8-1/2" Apart, **Lifetime Warranty**

Item #	LEDs	Lens	Package	Pack
36827B	10 Red	Red	Carded	1 Pc./Card

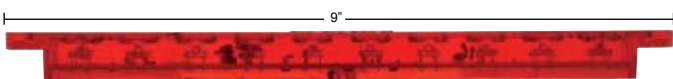
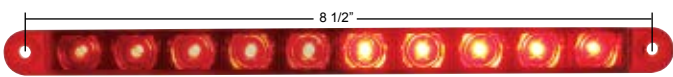

NEW!

Stainless Steel Locking Tie

DESCRIPTION

- 304 Grade Stainless Steel Never Rusts
- Withstands Temperatures Up to 2,500 Degrees
- Quick Easy Ball-Bearing Locking Mechanism Holds Tight
- Perfect for Securing Exhaust Wrap on Headers & Pipes

Item #	Description	Package	Pack
90322	8" Locking Tie	Carded	8 Pcs./Card
90323	14" Locking Tie	Carded	4 Pcs./Card



NEW!

10 LED 9" Split Turn Function Light Bar - Chrome Bezel

DESCRIPTION

- 10 LED 9" Split Turn Function Light Bar with Chrome Plastic Bezel 9-3/8" L x 7/8" W x 1" H
- Dual Function with 10 LED Running Light & 5 LED Lefthand & 5 LED Righthand Turn Signal
- Easy Electrical Hookup with 4 Wires: Ground, Tail, L/H High, R/H High
- Bezel Mounting Screws Are Adjustable 4-1/2" to 7-3/8" Apart
- Includes Stainless Steel Mounting Hardware
- 9" Chrome Plastic Light Bar Bezel Also Available Separately Item # 30932B

Item #	LEDs	Lens	Package	Pack
32778	10 Red	Red	Bulk	1 Pc.





1940 Ford Passenger Car 1940-41 Ford Pickup Front / Rear Bumper

DESCRIPTION

- Excellent Heavy Duty Steel Reproduction of the 1940 Ford Bumper
- Includes All The Original Contour Detail
- Beautifully Chrome Plated with Triple Plating Process
- Fits 1940 Ford Passenger Car's Front or Rear. Also 1940-41 Ford Truck's Front

Item #	Description	OEM Number	Pack
110266	Front /Rear Bumper	01A-17757-A	1 Pc./Box

1955-57 Chevy & GMC Truck Headlight Bucket



DESCRIPTION

- Quality Steel Reproduction of the 1955-57 Chevrolet and GMC Truck Headlight Bucket
- Includes Headlamp Bulb Retaining Ring and Electrical Pigtail
- Fits Both LH and RH Sides

Item #	Description	OEM Number	Pack
110283	Headlight Bucket	897795	1 Pc./Box



1968-77 Ford Bronco Door Skin



DESCRIPTION

- Excellent Stamped Sheet Metal Reproduction of the Door Skin with All of the Original Contour Detail
- Perfect for Replacing That Damaged Door Skin on the Original Door Shell
- Black EDP Coated Finish

Item #	Application	OEM Number	Pack
110356	Lefthand	C9TZ-9720125-A	1 Pc./Box
110357	Righthand	C9TZ-9720124-A	1 Pc./Box



1932 Ford Closed Car Inside Door Handle Shaft Remote Relay Triangle Set

DESCRIPTION

- Heavy Duty Steel Reproduction of the Door Handle Shaft Remote Relay Triangle
- Fits Most 1932 Ford Closed Cars, except 3W
- Includes LH and RH Triangle Plates With Shafts, Lock Detent Springs and Attaching Rivets & Tension Washers

Item #	Description	Package	Pack
B20012-TPS	32 Car Door Relay Set	Bulk	1 Set/Bag

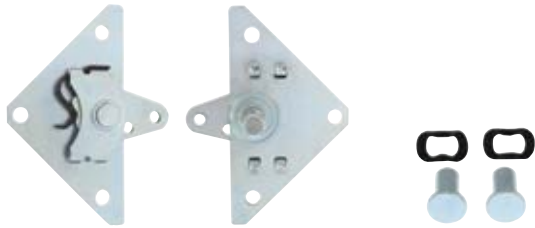

1967-72 Chevy & GMC Tail Light Lens - Fleetside

DESCRIPTION

- Great Looking Replacement Lens (No GM Markings)
- Injection Molded from High Quality Red Polycarbonate Plastic
- Fits Both LH and RH Sides, Sold Each

Item #	Description	Package	Pack
C677209	Red Tail Light Lens	Bulk	1 Pc.
110215	Tail Light Gasket	Bulk	1 Pair

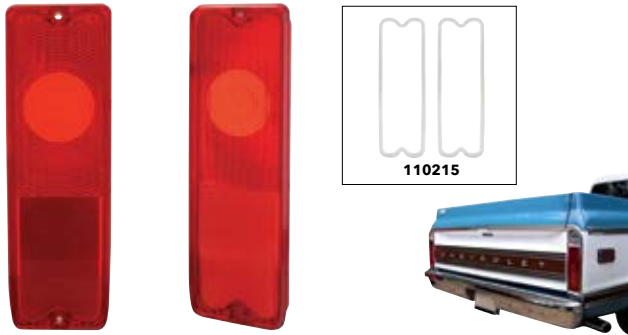

Stainless Steel Guide Headlight Visor

DESCRIPTION

- Great Classic Look & Upgrade for All Guide Style 7" Headlights
- Visor Has Built-In Bulb Retailer Ring for Easy Installation
- Polished 430 Stainless Steel, Sold Each

Item #	Description	Package	Pack
31519	Guide Headlight Visor	Bulk	1 Pc.



2 - Pack Metal License Frame Kit

DESCRIPTION

- Kit Includes 2 License Plate Frames, 4 Screws & 4 Screw Caps
- Available with Chrome Steel or Black Powder Coated Finish

Item #	Description	Package	Pack
49998	Chrome License Plate Frames	Carded	1Kit/Card
49999	Black License Plate Frames	Carded	1Kit/Card



Trucker Girl Key Chain / Bottle Opener

DESCRIPTION

- High Quality Aluminum with Polished & Clear Anodized Finish
- Includes Standard Key Ring and Attractive Retail Card Packaging

Item #	Description	Package	Pack
99098	Trucker Girl Bottle Opener	Carded	1 Pc./Card

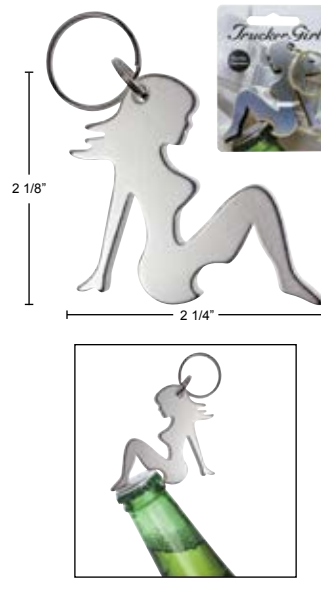

United Pacific LED "Mirage" Light Display

DESCRIPTION

- United Pacific LED "Mirage" Light Display
- Multi Functional Control Allows Drivers to See the Lights in Different Modes of Operations

Item #	Description	Package	Pack
99087	"Mirage" Light Display	Boxed	1 Pc./Box

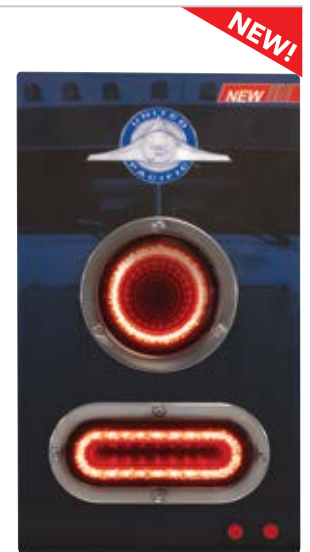



NEW ITEMS

MAY 2017



1966-77 Ford Bronco Rocker Panel

DESCRIPTION

- Excellent Stamped Sheetmetal Reproduction of the Rocker Panel with All of the Original Contour Detail
- Fits 1966-77 Ford Bronco
- Die Stamped with 18 Gauge Steel, Coated in Weldable Primer
- Fits Both the Left and Right Hand Sides

Item #	Description	OEM Number	Pack
110336	Rocker Panel	C6TZ-9610128-B	1 Pc./Box



110397

1966-77 Ford Bronco Windshield Frame

DESCRIPTION

- Accurate reproduction of the front steel windshield frame with all of the original contours and details
- Fits 1966-77 Ford Bronco
- Roll-Formed with 16 Gauge Steel, Coated with Black EDP
- Windshield Frame includes Windshield Hinge Attached
- Windshield Frame Hinge Available Separately, UP #: 110398

Item #	Description	OEM Number	Pack
110397	Windshield Frame	C9TZ-9703114-A	1 Pc./Box
110398	Windshield Frame Hinge	-	Bulk = 1 Pc.



Windshield Frame Hinge Available Separately, UP # 110398

1966-77 Ford Bronco Bed Stake Corner

DESCRIPTION

- Quality Stamped Sheetmetal Reproduction with All of the Original Contour Detail
- Fits 1966-77 Ford Bronco
- Die Stamped with 16 Gauge Steel, Coated in Weldable Primer
- It is the Essential Component for Connecting the Quarter Panel and the Taillight Panel
- Sold Individually, Please Specify LH or RH Side

Item #	Application	Description	Pack
110350	Lefthand	Bed Stake Corner	1 Pc./Box
110351	Righthand	Bed Stake Corner	1 Pc./Box



1968-77 Ford Bronco Windshield to Cowl Mount

DESCRIPTION

- Essential Component for Connecting the Firewall and the Front Windshield Hinge
- Fits 1968-77 Ford Bronco
- Die Stamped with 18 Gauge Steel, Coated in Weldable Primer

Item #	Description	Package	Pack
110349	Windshield to Cowl Mount	Boxed	1 Pc./Box





1968-77 Ford Bronco Door Jamb

DESCRIPTION

- Excellent Stamped Sheetmetal Reproduction of the Door B-Pillar Jamb Post with All of the Original Contour Detail
- Die Stamped with 18 Gauge Steel, Coated in Weldable Primer
- Fits 1968-77 Ford Bronco
- Includes Door Latch Striker Plate, Striker Plate Shims, Striker Plate Screws & Upper Corner Filler Strip
- Sold Individually, Please Specify LH or RH Side

Item #	Application	OEM Number	Pack
110354	Lefthand	C8TZ-9628161-A	1 Set/Box
110355	Righthand	C8TZ-9628160-A	1 Set/Box



1939-40 Ford Coupe 1940 Ford Convertible Under Deck Lid Panel

DESCRIPTION

- Quality Stamped Sheet Metal Reproduction of the Under Deck Lid Panel and Floor Pocket Covers, Follows All of the Original Contour Detail
- Fits 1939-40 Ford Coupe & 1940 Convertible
- Die Stamped with 18 Gauge Steel, Coated in Weldable Primer
- Package Contains One Under Deck Lid Panel and a Pair of Floor Pocket Covers

Item #	Description	OEM Number	Pack
110320	Under Deck Lid Panel	91A-7740324	1 Set/Box

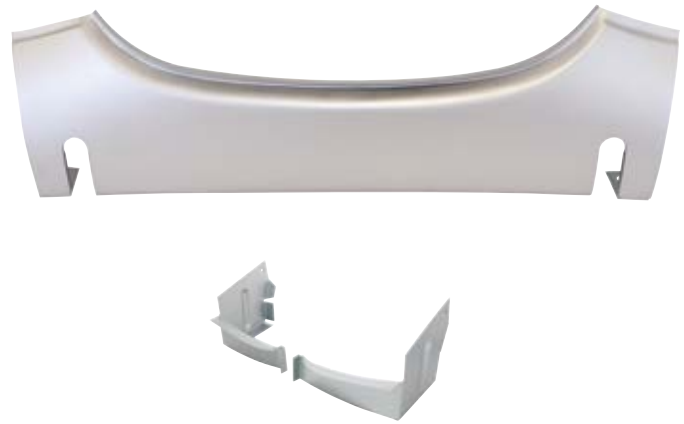

1939-40 Ford Passenger Car Floor Pan - Front

DESCRIPTION

- Excellent Stamped Sheet Metal Reproduction of the Front Floor Pan with All of the Original Contour Detail
- Fits 1939-40 Ford Passenger Car
- Die Stamped with 19 Gauge Steel, Coated in Weldable Primer
- Features Spot Welded Bow-Tie Style Brackets with 4 Caged 3/8-24 Nuts for Seat Rail Mounting

Item #	Description	Package	Pack
110228	39-40 Front Floor Pan	Boxed	1 Pc./Box



1964 1/2-68 Ford Mustang Convertible Torque Box

DESCRIPTION

- Die Stamped with Heavy 14 Gauge Steel, Coated with Black EDP
- Fits 1964 1/2-68 Ford Mustang Convertible
- Sold Individually, Please Specify LH or RH Side

Item #	Application	Description	Pack
110394	Righthand	64 1/2-68 Torque Box	Bulk = 1 Pc.
110395	Lefthand	64 1/2-68 Torque Box	Bulk = 1 Pc.



1964 1/2-70 Ford Mustang Convertible Full Rear Frame Rail

NEW!

DESCRIPTION

- Die Stamped with Heavy Duty 14 Gauge Steel, Coated with Black EDP with All of the Original Contour Detail
- Fits 1964 1/2-70 Ford Mustang Convertible
- Sold Individually, Please Specify LH or RH Side

Item #	Application	Description	Pack
110284	Righthand	65-70 Full Rear Frame Rail	1 Set/Box
110285	Lefthand	65-70 Full Rear Frame Rail	1 Set/Box



1955-62 Volkswagen Bus Type 2 Front Bench Seat Frame / Spring Set

NEW!

DESCRIPTION

- Excellent Reproduction of the Type-2 Bus Front Bench Seat Frame and Spring Set
- Fits 1955-62 Volkswagen Bus
- Set Includes Upper Seat Spring Frame, and Lower Seat Spring Frame

Item #	Description	OEM Number	Pack
110227	Seat Frame/Spring	211-881-370	1 Set/Box

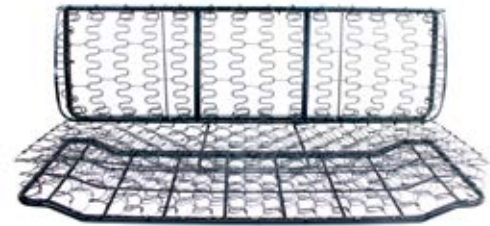

1947-54 Chevy Truck Hood Latch Panel

NEW!

DESCRIPTION

- Die Stamped with 18 Gauge Steel, Coated with Black EDP, or Chrome Plated
- Has Radiator, Fender, and Grille Bar Mounting Bolt Holes
- Includes Hood Latch Installed

Item #	Description	Package	Pack
110339	Black Hood Latch Panel	Boxed	1 Pc./Box
110340	Chrome Hood Latch Panel	Boxed	1 Pc./Box



1957 Chevy Bel Air / 120 / 150 Quarter Panel Fin Corner

NEW!

DESCRIPTION

- Fin Corners Are Die Cast & Beautifully Chrome Plated
- Gas Tank Door Is Stamped Steel & Chrome Plated

Item #	Description	Package	Pack
110179	Lefthand Fin Corner	Boxed	1 Pc./Box
110180	Righthand Fin Corner	Boxed	1 Pc./Box
110181	Gas Tank Door	Boxed	1 Pc./Box



1951 Thru 1972 Chevy & GMC Truck Chrome Vent Window Frames



DESCRIPTION

- Beautifully Chrome Plated
- Sold in Pairs

Item #	Description	OEM Number	Pack
122511	51-55 Vent Window	3699713 - L/H 3699714 - R/H	1 Pair/Box
122551	55-59 Vent Window	-	1 Pair/Box
122601	60-63 Vent Window	-	1 Pair/Box
122641	64-66 Vent Window	-	1 Pair/Box
122671	67-72 Vent Window	-	1 Pair/Box

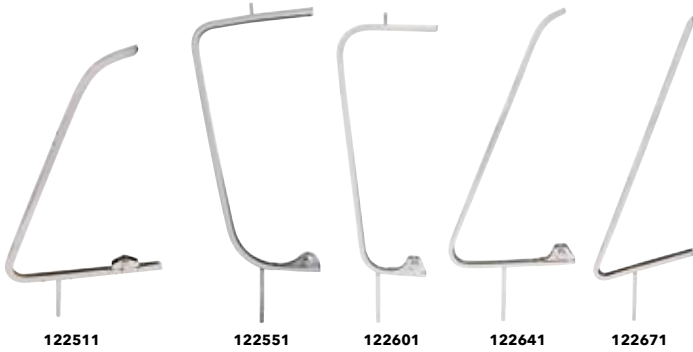

1960-66 Chevy & GMC Truck Glove Box Hinge Bushing



DESCRIPTION

- OD 0.622", ID 0.275", Thickness 0.298"

Item #	Description	Package	Pack
110402	Glove Box Hinge Bushing	Bag	Bulk = 1 Pc.



1928-34 Ford "Shorty" Dogbone Shock Link



DESCRIPTION

- Perfect Solution for Vehicles with Dropped Axles
- Used with Original Shock Arm and Perches
- Heavy Cast Steel with Rubber Bushings, Available in Painted Black and Polished Stainless Steel

Item #	Description	Package	Pack
B24101	Black Shorty Shock Link	Bag	1 Pc./Bag
B24101SS	Stainless Shorty Shock Link	Bag	1 Pc./Bag

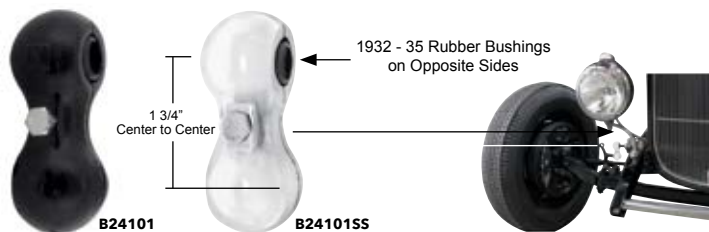

17 LED Tail Light Assembly with Flush Mount Bezel



DESCRIPTION

- 17 Super Bright Red LEDs with Flush Mount Bezel
- Light Is 3 3/4" Dia. and 3/4" Tall
- Mounting Stud Are Approximately 3 7/16" Apart
- Includes Installation Hardwares and Mounting Pad

Item #	Style	LEDs	Lens	Pack
110406	Chrome	17	Red	1 Pc./Card
110407	Chrome Grill	17	Red	1 Pc./Card
110409	Black Grill	17	Red	1 Pc./Card



1928-31 Ford Model A Tail Light with Black Housing



DESCRIPTION

- Gloss Black Powder Coated Housing with Black Steel Rim
- Lefthand Tail Lamp Has License Plate Illuminator Lens on Bottom
- Vintage Style Cloth Braided Wires for an Authentic Look

Item #	Description	Package	Pack
A1039-12VRL	L/H Tail light	Boxed	1 Pc./Box
A1040-12VRL	R/H Tail light	Boxed	1 Pc./Box





NEW ITEMS

JUNE 2017



1973-87 Chevy & GMC Truck Sequential LED Tail Light

DESCRIPTION

- 56 Super Bright Red LEDs with 12 White LEDs with Polycarbonate Lens
- Features Sequential Operation with Selector Switch to Select On or Off
- Features Sequential-Once Brake Attention Function
- Epoxy Coated, Fully Sealed Electronics, 1157 Plug for Tail Lamp and 1156 Plug for Backup Light
- Solid State Circuit Boards are Designed for 7.7-14.0 VDC
- Sold Individually, Please Specify Driver or Passenger Side, **Lifetime Warranty**
- Recommended to Upgrade Under Dash Flasher to 90652 LED Flasher



Item #	Description	Package	Pack
CTL7387LED-L	73-87 LED Tail Light L/H	Carded	1 Pc./Card
CTL7387LED-R	73-87 LED Tail Light R/H	Carded	1 Pc./Card



1973-87 Chevy & GMC Truck Tail Light Lens Gasket



DESCRIPTION

- Black EVA Foam
- Precision Die Cut to OE Specifications for a Perfect Fit
- Sold in Pairs

Item #	Description	Package	Pack
C738703	73-87 Tail Light Lens Gasket	Bag	1 Pair

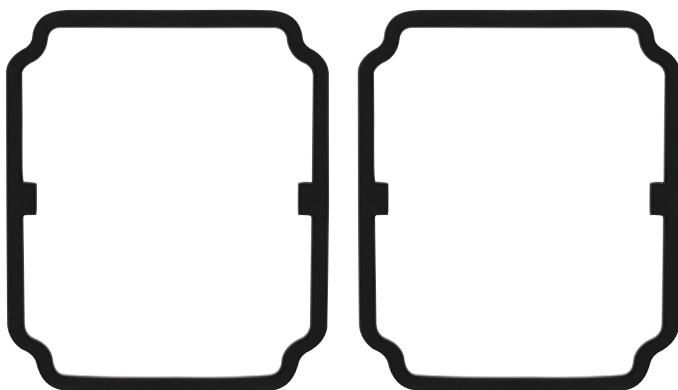

12V LED Flasher with Polarity Reversing Adapter



DESCRIPTION

- Use on Vehicles with LED Tail Lights, Front Turn Signals, and Side Marker
- Simply Replaces the Original 552 or 536 Under Dash Flasher, Plug & Play
- Includes 2-Terminal Flasher and Polarity Reversing Adapter
- Polarity Reversing Adapter Solves Reversed Issues on Some Applications

Item #	Description	Package	Pack
90652	552/536 LED Flasher	Bag	1 Pair



1932 Ford Closed Car Inside Door Handle

DESCRIPTION

- Beautifully Die Cast and Chrome Plated
- Fits All 1932 Ford Closed Cars
- Matching Window Crank Handle Is Available: Item # B20134
- Matching Polished Stainless Steel Escutcheon Is Available: Item # B20137

Item #	Description	Package	Pack
B20133	Inside Door Handle	Bag	1 Pc.

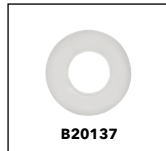

1932 Ford Car & Truck Bumper Bolt

DESCRIPTION

- Polished Stainless Bumper Bolt
- Includes Stainless Nut and Lock Washer
- Also Available: B20092 Chrome Bumper & B20301 Stainless End Cap

Item #	Description	Package	Pack
B20302	32 Bumper Bolt	Bag	1 Set



1932 Ford 5-Window Coupe Upper Seat Upholstery Retainer Strip

DESCRIPTION

- Fits 5-Window Coupe & Sport Coupe
- Mounts on the Rear of the Upper Seat Back Wood
- Used to Hold the Seat Upholstery and Package Tray Filler Upholstery in Place
- Black EDP Coated Finish

Item #	Description	Package	Pack
B20409	Upholstery Retainer Strip	Bag	1 Pc.

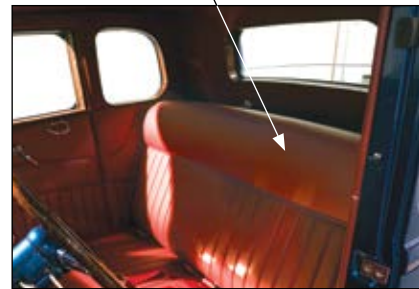

Skulls Pistol Grip Shift Knob

DESCRIPTION

- Skull Pistol Grip Shift Knob
- Zinc Die-Cast, Available in Black/Chrome, Chrome or Matte Black Finish
- Universal Hex Screw Mount Design, Includes Mounting Hardware

Item #	Style	Finish	Package	Pack
70711 (New)	Skulls	Black/Chrome	Carded	1 Pc./Card
70646	Skulls	Chrome	Carded	1 Pc./Card
70657	Skulls	Black	Carded	1 Pc./Card



70711 (New)

70646

70657



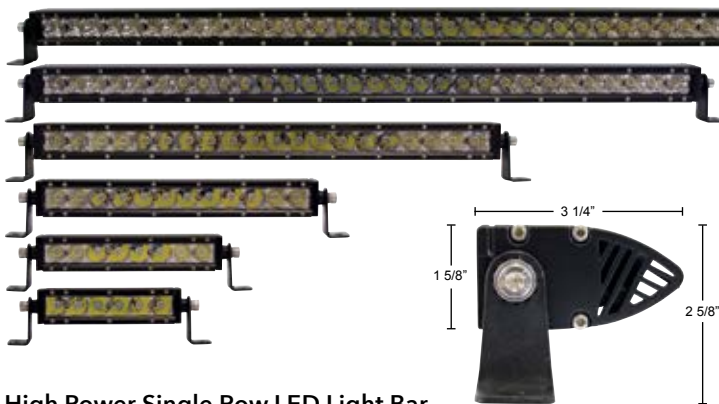

High Power Single Row LED Light Bar

DESCRIPTION

- 5W High Power Single Row "Cree" LED Light Bar
- Spot/Flood: Inner LEDs (Spot) / Outer LEDs (Flood)
- 12 V Application, IP 67 Rated
- Available in 6 Different Lengths, Heavy Duty Aluminum Housing
- **3 Year Warranty**

Item #	LEDs	Function	Lumens	Length	Pack
36611	6	Spot	2100 lm	7"	1 Pc./Box
36612	8	Spot/Flood	2800 lm	8 3/4"	1 Pc./Box
36613	12	Spot/Flood	4200 lm	12 1/2"	1 Pc./Box
36614	20	Spot/Flood	7000 lm	20 1/2"	1 Pc./Box
36615	30	Spot/Flood	10500 lm	30 1/4"	1 Pc./Box
36616	40	Spot/Flood	14000lm	42"	1 Pc./Box



30 LED Round 4" Push-In Grommet Mount Light Kit

DESCRIPTION

- Kit Includes Light, Grommet (Item # 31515) and Plug (Item # 34212)
- Recommended Plug: Item # 34212
- **Lifetime Warranty**

Item #	LEDs	Lens	Package	Pack
36832BRK	30 Red	Red	Bag	1 Kit



Kit (Item # 36832BRK) Includes



14 LED 4" Dual Color Round 4" Push-In Grommet Mount Lights

DESCRIPTION

- 3 Contact Female Plug with An Additional Yellow Wire to Activate the Secondary Function/Color
- DOT/SAE Approved, Secondary Color for Auxiliary Use Only
- 12 volt. Uses Standard Commercial 3-Pin Electrical Connector Plug, Item # 34212/34216
- Mounts With Standard 4" Rubber Push-In Grommet, Item # 31515
- **Lifetime Warranty**

Item #	Primary Color	Secondary Color	Lens	Pack
36528	Red	Amber	Clear	1 Pc./Card
36529	Red	Blue	Clear	1 Pc./Card
36530	Red	White	Clear	1 Pc./Card
36531	Amber	Blue	Clear	1 Pc./Card
36532	Amber	White	Clear	1 Pc./Card

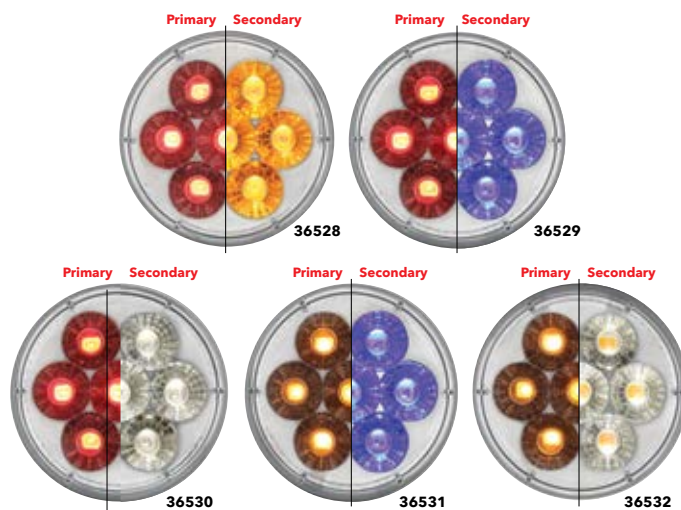

"DOUBLE FURY"
2 COLOR LEDs

NEW!

Scorpion License Plate Frame

DESCRIPTION

- High Quality Zinc Die-Cast Metal Frame with Satin Black Finish
- Available with Chrome Scorpions or Black Scorpions

Item #	Description	Finish	Pack
50115 (New)	Scorpion License Frame	Black	1 Pc./Card
50034	Scorpion License Frame	Chrome	1 Pc./Card



50115 (New)



50034

U.S. Military Adhesive Metal Medallion - 1 3/4"

DESCRIPTION

- 1 3/4" Round U.S. Military Adhesive Metal Medallion
- Minted in A Brass Alloy and Finished in Bronze
- Officially Licensed Product

Item #	Description	Package	Pack
22974	U.S. Air Force Medallion	Carded	1 Pc./Card
22975	U.S. Army Medallion	Carded	1 Pc./Card
22976	U.S. Navy Medallion	Carded	1 Pc./Card
22977	U.S. Marine Corps Medallion	Carded	1 Pc./Card



22974



22975



22976



22977

NEW!

Skulls License Plate Frame

DESCRIPTION

- High Quality Zinc Die-Cast Metal Frame with Satin Black Finish
- Available with Chrome Skulls or Black Skulls

Item #	Description	Finish	Pack
50116 (New)	Skulls License Frame	Black	1 Pc./Card
50037	Skulls License Frame	Chrome	1 Pc./Card



50116 (New)



50037

NEW!

Flame License Plate Frame

DESCRIPTION

- High Quality Zinc Die-Cast Metal Frame with Satin Black Finish
- Available with Chrome Flames or Black Flames

Item #	Description	Finish	Pack
50117 (New)	Flame License Frame	Black	1 Pc./Card
50038	Flame License Frame	Chrome	1 Pc./Card



50117 (New)



50038



2016 New Items Product Flyer
Item # ANF1216

Available Now!



NEW ITEMS

JULY 2017

1948-50 Ford Pickup Steel Rear Fender

- Die Stamped with Quality 20 Gauge Sheetmetal
- Features All Original Fender Curvature and Mounting Pattern
- Finished with United Pacific *Classic-Coat*[®]
- Sold Individually, Please Specify LH or RH Side
- **Upsize Freight Policy**

110431 Lefthand **110432** Righthand



110431



110432



110433



110434

1951-52 Ford Pickup Steel Rear Fender

- Accurate Reproduction Stamped 20 Gauge Sheetmetal
- Features All the Correct Changes that Made Them Different from the 1948-50 Models
- Finished with United Pacific *Classic-Coat*[®]
- Sold Individually, Please Specify LH or RH Side
- **Upsize Freight Policy**

110433 Lefthand **110434** Righthand

1932-34 Ford Truck Lower Rear Door Post Brace

- Die Stamped with Quality 19 Gauge Sheetmetal
- Features All of the Rivet Holes, Just like the Original
- Coated in Black EDP

B21026 Lower Rear Door Post Brace



B21026

B21025

B21022

B21024

1932 Ford Truck Subrails

- Excellent Heavy 16 Gauge Stamped Steel with All Original Detail
- Features Body Mounting Holes, and Rivet Holes and Fuel Tank Mounting Holes As Original
- Also Fits 1933-34 Trucks with Modification of Length at Front
- Coated in Black EDP
- Sold Individually, Please Specify LH or RH Side

B21022 Righthand **B21023** Lefthand

B21023

1932-34 Ford Truck Subrail Cross Channels

- Heavy 16 Gauge Stamped Steel with All Original Detail
- Features Squared Holes for Carriage Bolts, Rivet Holes, Rear Channel Has the 3 Rectangular Cut-outs for Back Rest Support Wood Pieces
- Coated in Black EDP
- Sold Individually, Please Specify Front or Rear Side

B21024 Front **B21025** Rear



1940 Ford Passenger Car Cowl Side Panel Set

- Die Stamped with 18 Gauge Sheetmetal
- Includes Upper Internal Connector Brackets
- Coated in Weldable Primer
- Sold in Pair

110267 Cowl Side Panels



1939-40 Ford Passenger Car Trunk Floor Tool Box Braces

- Center Brace Made with 18 Gauge Sheetmetal
- L/H & R/H Braces Are Made with Quality 20 Gauge Sheetmetal
- Includes the R/H, L/H, and Center Brace for the Openings on the Lower Deck Panel of the Floor Tool Box
- Coated in Weldable Primer
- Total 3 Pieces in a Set

110231 Floor Tool Box Braces



1966-77 Ford Bronco Vent Window Assembly

- Retains All Original Contour and Detail
- Black Coated Inner Frame with Untinted Glass
- Chrome Plated Vent Handle and Outer Frame with Door Window Felt
- Sold Individually, Please Specify Driver or Passenger Side

110273 Lefthand **110274** Righthand



1966-77 Ford Bronco Rear Window Prop

- Accurate reproduction of the Steel Rear Window Props with Toggle Latch Mechanism As Original
- Bright Zinc Plated As Original
- Sold in Pair

110399 Rear Window Prop



1966-77 Ford Bronco Bed Support Cross Rail

- Die Stamped with Heavy 14 Gauge Sheetmetal - Features All Original Contour and Detail - Coated in Weldable Primer

110327 Bed Support Cross Rail



1966-77 Ford Bronco Door Hinge

- All Mounting Holes and Threads Fully Machined & Ready to Install
- Precision Steel for Strength & Durability
- Sold Individually, Please Specify LH or RH Side

110352 Lefthand **110353** Righthand



1966-77 Ford Bronco Heater Vent

- Injection Molded with High Quality Plastic
- Has All of Original Contour and Mounting Holes

110330 Heater Vent



1966-77 Ford Bronco Cargo Bed / Floor Pan

- Die Stamped with Quality 17 Gauge Sheetmetal
- Features All Original's Groves and Mounting Holes
- Coated in Weldable Primer

110328 Cargo Bed / Floor Pan

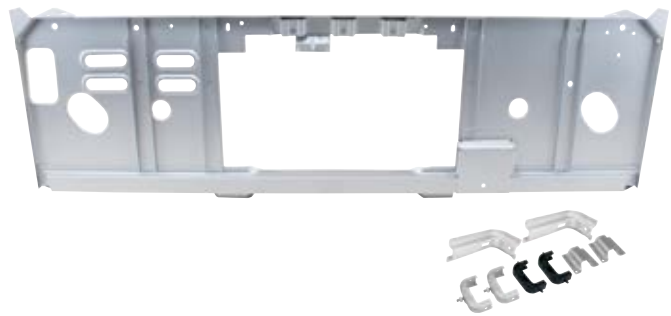

1966-77 Ford Bronco Radiator Support

- Die Stamped 16 Gauge Sheetmetal with Reinforcing Steel Gussets
- Includes Heavy 12 Gauge Lower Radiator Support Brackets & Cradles
- Coated in Weldable Primer

110385 Radiator Support



1955-57 Chevy Truck Hood Latch Panel

- Made with High Quality 20 Gauge Sheetmetal
- Features All Original Contour and Detail
- Coated in Black EDP

110341 Hood Latch Panel



1964 1/2-66 Ford Mustang Coupe & Convertible Trunk Lid

- Die Stamped 19 Gauge Sheetmetal with All Original Contour Detail
- Coated in Black EDP

110393 Trunk Lid



1955-56 Chevy Truck Grille

- Quality 19 Gauge Steel Reproduction
- Has All Original Bar Spacing and Contour
- Includes All of the Correct Mounting Pattern for Quick and Easy Installation
- Black Powder Coated Finish

110388 Truck Grille

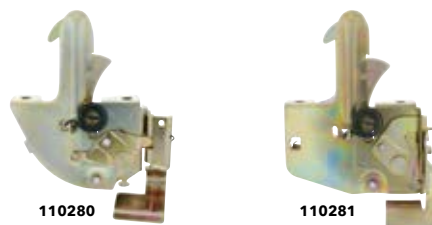

1955-59 Chevy Truck Hood Latch Assembly

- Die Stamped with Heavy Gauge Sheetmetal
- Features All Original Mechanical Design
- Pre-Assembled for Easy Installation

110280 55-57 Chevy Truck

110281 58-59 Chevy Truck



1960-66 Chevy & GMC Truck Bed Side Step Hanger

- Die Stamped with Heavy 14 Gauge Steel
- Features All Original Frame to Step Mounting Patterns
- Coated in Black EDP
- Sold Individually, Please Specify LH or RH Side

110400 Righthand

110401 Lefthand

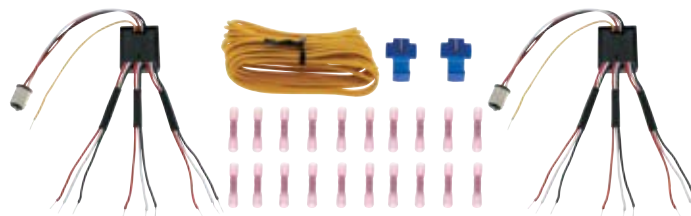

UPGRADED Features Sequence Once Brake Attention Function

Sequential LED Module Kit

- Features Sequence Once Brake Attention Function
- This Kit Will Convert Three 12 Volt LED Tail Lights to Sequential Operation
- Kit Includes Two Sequencer Modules, Hookup Wire, Wire Connectors and Instructions

90656 Sequential LED Module Kit



1928-31 Ford Tail Light Bracket Reinforced Plate

- Backing Plate for Tail Light Brackets on All Model-A Fords
- OEM # A-13463
- Coated in Black EDP
- Sold Each

A8001 Tail Light Bracket Reinforced Plate



United Pacific Flat Bill Cap

- Quality Black & Grey Flat Bill Hat
- Embroidered With The Classic UPI Logo
- Adjustable Size Strap On Back

99099 United Pacific Flat Bill Cap



NEW ITEMS

AUGUST 2017

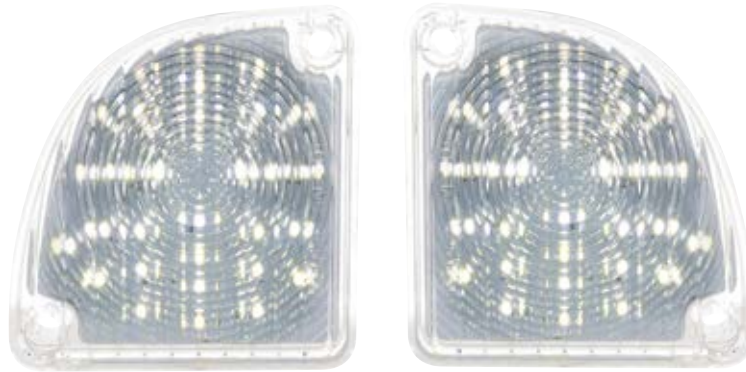

 Easy Installation
Plug & Play

1967-72 Chevy & GMC Truck LED Back-Up Light

- 30 White LED Back-Up Light, Complete with Desirable Bullseye Lens
- Epoxy Coated, Fully Sealed Electronics, 1156 Plug
- Solid State Circuit Boards are Designed for 7.7-14.0 VDC
- **Lifetime Warranty**

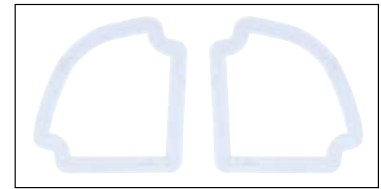

110200 Left Hand - 1 Pc. / Card **110201** Right Hand - 1 Pc. / Card **110202** Light Gasket - 1 Pair/Bulk



1967-72 Chevy & GMC Truck A/C Center Vent

- High Quality Die Cast Zinc and Chrome Plated
- Mounting Hardware Not Included

110582 1 Pc. / Box



304
Stainless

1928-37 Ford Truck Tail Light Bracket

- Fits All 1928-37 Truck Tail Lights, Except Early 1928 Drum Tail Light
- High Quality Investment Cast 304 Stainless Steel
- Beautifully Polished Finish
- Fits Lefthand and Righthand Side
- OEM # B-13470-B
- Sold Each

A1035 1 Pc. / Bulk

Now Available with KPH Speedometer



110343 **NEW**

1953-55 Ford F-100 Truck Gauge Set

- Now Available in KPH or MPH
- "6 in 1" Package has Speedo, 8K Tach, Fuel, Temp, Oil Pres, Volts
- Features Machined Aluminum Bezel, LED Illumination, Integrated Turn Signals, Blue Halo High Beam Indicator, Wiring Harness, Includes Sending Units, (Except Fuel Sending Unit Not Included)



110005



110343 KPH - 1 Pc. / Box

110005 MPH - 1 Pc. / Box



DUAL FUNCTION HALO

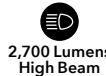

7" High Power LED Projection Headlight with Dual Function LED Halo Ring

- 7" Headlight: 2,700 Lumen High Beam and 1,200 Lumen Low Beam
- Dual Color White/Amber Auxiliary LED Halo Ring with Amber Automatic Override Feature
- Die Cast Housing and Polycarbonate Lens Provide Maximum Protection and Durability
- Solid State Design Resists Shock and Vibration, IP67 Weatherproof Rating
- Easy Installation. Fits OEM Housing and Plugs Into Existing Headlight Wiring Harness
- LED Halo Ring Requires Additional Wiring Installation
- DOT and SAE Headlight Compliant
- Sold Each

31496 1 Pc. / Color Packaging

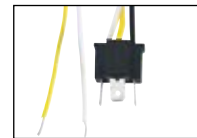

NEW COLOR PACKAGING
CONTACT US FOR DETAILS



6 High Power LED Rectangular Driving/Work Light

- Heavy Duty Die Cast Aluminum Housing, 1,150 Lumens
- Stainless Steel Mounting Bracket and Hardware
- Operates on 9V-30V, Draws 1.4 Amps at 12V
- **3 Year Warranty**

36510 1 Pc. / Card



1,150
LUMENS

3w X 6
HIGH POWER

9v-30v
MULTIPLE VOLTAGE



5" x 7" LED Rectangular Light with LED Light Bar

- 9 High Power LED 5" x 7" Rectangular Light
- High and Low Function
- Reinforced Aluminum Reflector
- Rugged Anti-Vibration Construction

34122 1 Pc. / Box



50114 NEW



50033

Tribal Flame License Plate Frame

- High Quality Zinc Die-Cast Metal Frame
- Available Chrome/Black Finish or All Satin Black Finish
- Fits Standard U.S. & Canadian 6" x 12" License Plates
- Sold Each

50114 **Black** - 1 Pc. / Card

50033 **Black/Chrome** - 1 Pc. / Card



NEW ITEMS

SEPTEMBER 2017



1932 Ford 5-Window Coupe Seat Frame Set

- Heavy Steel Die Stampings with All the Detail of the Original 5-Window Seat Frame
- Seat Tracks, Adjusters and Wood Sold Separately
- All 3 Pieces are Coated in Black EDP

B20401 1 Set / Box

1973-87 Chevy & GMC Truck Exterior Mirror

- LED Turn Signal Arrow Hidden Inside Mirror Glass (Hidden When Off)
- Beautifully Die Cast & Chrome Plated Mirror Head and Arm
- Righthand Side Available with Convex Mirror for Wide Angle Visibility
- Easy Hookup, Just Route Wire through Door Jamb and Connect to Front Turn Signal Wires Under Dash Near Steering Column
- Includes Mounting Pad, Mounting Bracket and Screws



C738710-LED **NEW**



NEW COLOR PACKAGING



- C738710** Fits L/H & R/H - 1 Pc. / Color Box
- C738710-LED** w/LED Turn Signal Arrow - L/H - 1 Pc. / Color Box
- C738710-CVX** w/Convex Wide Angle Mirror - R/H - 1 Pc. / Color Box
- C738710-CVXLED** w/LED Signal Arrow & Convex Mirror - R/H - 1 Pc. / Color Box



1966-77 Ford Bronco Heater Box

- Accurate Reproduction Heater Box for 1966-77 Ford Bronco
- Main Body is Made of High Strength Fiber Composite with Steel Top Plate
- Features Original Style Defroster Duct Selector
- Original Style Speed Nuts Included for Fan Motor Mounting

110329 1 Pc. / Box



1948-52 Ford Truck Transmission Cover

- Steel Reproduction Transmission Cover for 1948-52 Ford Trucks, Coated with Weldable Primer
- Excellent Quality 19 Gauge Steel
- Features Original Contour Detail
- Includes 5/16-18 Caged Nut for Accelerator Pedal Stop

110441 1 Pc. / Box



110438



110439

1951-52 Ford Truck Bed Side Panel

- Quality Sheet Metal Reproduction for 1951-52 Ford Truck Bed Side Panel, Coated in Weldable Primer
- High Quality 16 Gauge Steel
- Features All Original Contour Detail
- Pre-Installed 5/16-18 Studs for Quick and Easy Rear Fender Mounting
- Sold Individually, Please Specify LH or RH Side

110438	Lefthand - 1 Pc. / Box
110439	Righthand - 1 Pc. / Box



110387 **NEW**



110388

1955-56 Chevy Truck Grille

- Has All Original Bar Spacing and Contour
- Includes 5/16-18 Square Nuts for Quick and Easy Installation
- Available in Chrome Plated with Triple Plating Process or Black EDP Finish

110387	Chrome - 1 Pc. / Box
110388	Black - 1 Pc. / Box



1967-72 GMC Truck Headlamp Mounting Bucket Set

- Excellent Quality Steel Reproduction Headlight Bucket Set for 1967-72 GMC Trucks
- Quality 19 Gauge Sheet Metal Stamped Buckets
- Each Bucket is Properly Timed with Grooves for Specific LH/RH and Hi/Lo Headlight Bulbs
- Chrome Plated Headlight Retainer Rings
- 6-32 Screws Included for Mounting Retainer Ring to Bucket
- 8 Pcs Total Per Set

110358 1 Set / Box



1969 Camaro RS LED Back-Up Light

- 27 White LED Back-Up Light, Complete with Polycarbonate Lens
- Epoxy Coated, Fully Sealed Electronics, 1156 Plug
- Solid State Circuit Boards are Designed for 7.7-14.0 VDC
- Fits L/H and R/H Side. Sold Each
- **Lifetime Warranty**

110443 1 Pc. / Card



110217 **Light Gasket** - 1 Pc. / Bulk

Fits 1969 RS Camaro Backup Light and 1969-72 Chevy & GMC Truck Cargo Light



110318



110319



NEW COLOR PACKAGING

1938-71 Passenger Car & Truck "GM" Locking Gas Cap

- High Quality Chrome Plated Gas Cap for GM Trucks & Passenger Cars
- Available with and without GM Logo
- Fits Most Early GM Gas Necks with 1.53" Opening
- Integrated Lock with Two Keys Included
- For Use Only on Vehicles Originally Equipped with Vented Gas Cap

110318	With GM Logo - 1 Pc. / Color Box
110319	Without GM Logo - 1 Pc. / Box



110424 **NEW**



190601



190602

13" Polished Stainless Wiper Blade - Bayonet Type

- Fits Many Classic GM & Ford Wiper Arms
- Use With 1960-66 Chevy & GMC Truck Wiper Arm, Item #: 190601, 190602

110424	13" Wiper Blade - 1 Pc. / Bag
190601	Wiper Arm, L/H - 1 Pc. / Bag
190602	Wiper Arm, R/H - 1 Pc. / Bag

Chrome Motorcycle Dual Tone Horns

- Super Loud 115 Decibel Sound
- Dual Tones: Low 410 HZ and High 510HZ
- Compact Design Ideal for Motorcycles & PowerSport Vehicles
- 12 Volt, Mounting Hardware Included

46101 1 Set / Card



50118



50124

Eagle Motorcycle License Plate Frame

- High Quality Zinc Die-Cast Metal Frame
- Available in Chrome and Chrome/Black Finish
- Fits All U.S. Motorcycle License Plates

50118 Chrome - 1 Pc. / Card

50124 Chrome/Black - 1 Pc. / Card



50128



50129

Flame Motorcycle License Plate Frame

- High Quality Zinc Die-Cast Metal Frame
- Available in Chrome and Chrome/Black Finish
- Fits All U.S. Motorcycle License Plates

50128 Chrome - 1 Pc. / Card

50129 Chrome/Black - 1 Pc. / Card

License Plate Frame with Third Brake Light or Backup Light

- Add a Third Brake Light or Backup Light to Any Classic Car, Truck or Hotrod
- 12 Volt, Easy Hookup to Your Existing Brake Light Switch, or Backup Light Switch
- Metal License Plate Frame Available in Satin Black Finish or Chrome
- Fits Standard U.S. & Canadian 6" x 12" License Plates
- Sold Each



36473



36475



36496



36481



36483

Black License Plate Frame / Black Light Bar Housing

- | | |
|--------------|---|
| 36473 | 14 Red LED/Red Lens - 1 Pc. / Card |
| 36475 | 14 Red LED/Clear Lens - 1 Pc. / Card |
| 36496 | 14 White LED/Clear Lens - 1 Pc. / Card |

- | | |
|--------------|---|
| 36481 | 24 Red LED/Red Lens GLO Light - 1 Pc. / Card |
| 36483 | 24 Red LED/Clear Lens GLO Light - 1 Pc. / Card |



39744



39746



39781



36497



36498

Chrome License Plate Frame / Chrome Light Bar Housing

- | | |
|--------------|---|
| 39744 | 14 Red LED/Red Lens - 1 Pc. / Card |
| 39746 | 14 Red LED/Clear Lens - 1 Pc. / Card |
| 39781 | 14 White LED/Clear Lens - 1 Pc. / Card |

- | | |
|--------------|---|
| 36497 | 24 Red LED/Red Lens GLO Light - 1 Pc. / Card |
| 36498 | 24 Red LED/Clear Lens GLO Light - 1 Pc. / Card |



Chrome Vintage Flashlight with Holder

- Cool Vintage Looking Metal Flashlight with Satin Chrome Finish
- Glass Lens with Adjustable Beam and Morse Code Button
- Holder Has Classic Hammertone Finish with Roller-Action Grip
- Holder Fits 1-7/8" Diameter Steering Columns
- Uses 2 "D" Cell Batteries (Not Included)

110587 1 Pc. / Box



Chrome Eagle Accent

- Highly Detailed Bald Eagle Design
- Show Quality Chrome Plating on Durable Weather Resistant Plastic
- Approximately 7 3/16" L x 1 3/4" W x 1/2" H"
- Double Sided Tape Mount

50119 1 Pc. / Card



31169 **NEW**



31238

**DUAL FUNCTION
AMBER POSITION LIGHT**



**NEW COLOR
PACKAGING**

6" x 4" Rectangular High Power LED High Beam Headlight with 6 LED Position LED

- 1 High Power LED for Headlight and 6 LED for Position Light
- Improves Visibility with Whiter High Beam Output that is Closer to Daylight
- Die-Cast Aluminum Housing Provides Maximum Protection from the Elements
- Solid State Design Resists Shock and Vibration
- Available in Single Function White Position LED or Dual Function High/Low Amber Position LED
- SAE/DOT FMVSS108

31169 **White LED Position Light** - 1 Pc. / Color Packaging

31238 **Amber LED Position Light** - 1 Pc. / Color Packaging

Technical Specification

LED High Beam		
12 - 24V DC Input	0.6 Amps / 14.5 Watt	FMVSS 108



NEW ITEMS

OCTOBER 2017

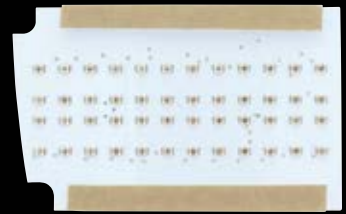
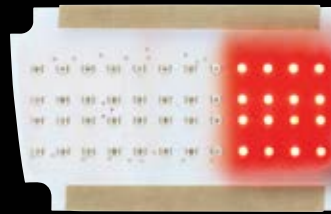
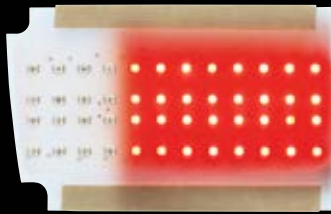
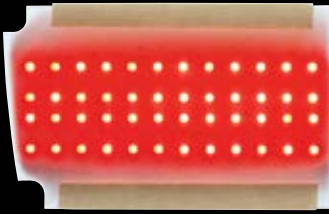

SEQUENTIAL
F · L · A · S · H

BRAKE
ATTENTION

1970 Chevy Chevelle 48 LED Tail Light Insert

- 48 Super Bright Red LED Tail Light Insert Board
- Solid State Circuit Boards are Designed at 7.7 - 14.0 VDC
- Available with or without Sequential Function
- Sold Individually, Please Specify LH or RH Side
- Recommended LED Turn Signal Flasher: Item # 90652

110155 **Lefthand** - 1 Pc. / Card

110156 **Righthand** - 1 Pc. / Card

110157 **Sequential Light Lefthand** - 1 Pc. / Card

110158 **Sequential Light Righthand** - 1 Pc. / Card



1957 Chevy Bel Air/210/150 Tail Light Assembly

- Beautifully Polished Stainless Steel Reproduction of the 1957 Chevy Bel-Air/210/150 Tail light Assembly
- Mirror-Like Polished Stainless Steel Casted Housing
- Features All of the Original Contour Detail
- Includes 1/4-20 Studs for Easy Installation
- Pre-Installed 1157 Bulb, and High Quality Red Tail Light Lens
- Sold Individually, Please Specify LH or RH Side

110182 **Lefthand** - 1 Pc. / Box

110183 **Righthand** - 1 Pc. / Box



1948-52 Ford Truck Floor Assembly

- Excellent Steel Reproduction of the 1948-52 Ford Truck Floor Assembly with United Pacific Classic-Coat® Weldable Primer
- High Quality 19 Gauge Stamped Steel with Heavy 14 Gauge Reinforcing Braces
- Features All of the Original Contour Detail
- Features 4x 1/2-24 UNF Caged Nuts and 1x 5/16-24 UNF Caged Nut
- **Oversize Freight Policy**

110435 1 Pc. / Box



1948-52 Ford Truck Firewall Assembly

- High Quality Stamp Steel Reproduction Firewall Assembly with United Pacific Classic-Coat® Weldable Primer, Support Brackets Also Included
- Main Firewall Panel is Die Stamped with Excellent Quality 19 Gauge Steel
- Features All of the Original Contour Detail
- Includes Heavy 14 and 16 Gauge Supporting Brackets
- **Oversize Freight Policy**

110440 1 Pc. / Box



9 High Power LED Driving/Work Light with Side LED - Spot/Flood Light

- 6 LEDs at Front - Spot Light and 3 LEDs at Side - Flood Light
- Stainless Steel Mounting Bracket and Hardware
- Operates on 12V-24V, Draws 2.8 Amps at 12V
- 1 Set / Box Includes 1 Left and 1 Right
- **3 Years Warranty**

36509 1 Set / Box



2,400
LUMENS

5w X 6
HIGH POWER

12v-24v
MULTIPLE VOLTAGE



LED Warning Module

- LED for Warning Module for Use with One LED
- Converts Regular LED lights Into Flashing Warning Lights
- 15 Selectable Flash Patterns
- 12 Volt, 5 AMP Maximum LED Load

90661 1 Pc. / Card



Ford 1932 5-Window & 1932-34 Pickup Catalog
Item # AC3209

Available Now!



36607

Stop/Turn/Tail

Back-Up/Reverse



36608



3 Contact Female Plug for Stop/Turn/Tail

3 Contact Female Plug for Back-Up



4" Round Combo Light with 12 LED S/T/T Light & 16 LED Back-Up Light

- 4" Round Stop/Turn/Tail Light with Back-Up Function
- 3 Contact Female Plug, Available in Color or Clear Lens
- DOT/SAE Approved
- Recommended Plug: Item # 34211/34212/34216
- **Lifetime Warranty**

36607 Red Lens - 1 Pc. / Card

36608 Clear Lens - 1 Pc. / Card

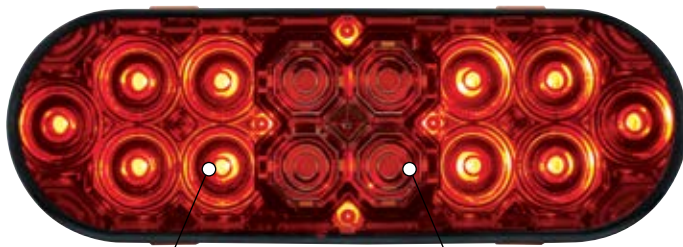

36609

Stop/Turn/Tail

Back-Up/Reverse



36610



3 Contact Female Plug for Stop/Turn/Tail

3 Contact Female Plug for Back-Up

6" Oval Combo Light with 14 LED S/T/T Light & 16 LED Back-Up Light

- 6" Oval Stop/Turn/Tail Light with Back-Up Function
- 3 Contact Female Plug, Available in Color or Clear Lens
- DOT/SAE Approved
- Recommended Plug: Item # 34211/34212/34216
- **Lifetime Warranty**

36609 Red Lens - 1 Pc. / Card

36610 Clear Lens - 1 Pc. / Card



NEW ITEMS

NOVEMBER 2017

DUAL FUNCTION

Red LED 3rd Brake

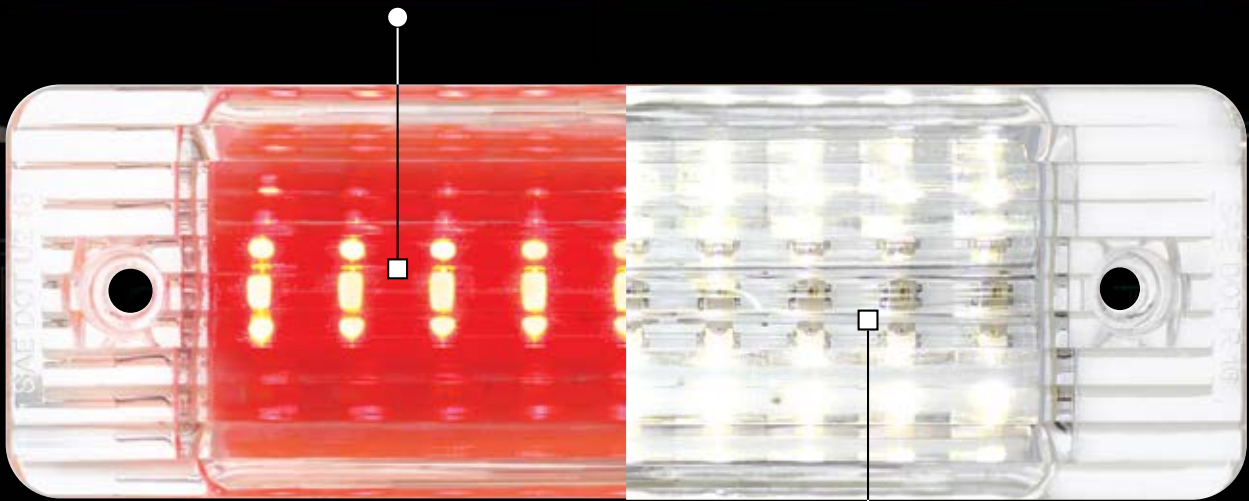

White LED Cargo Light



1967-72 Chevy & GMC Truck LED 3rd Brake & Cargo Light

- 18 White LED Cargo Light with 9 Red LED 3rd Brake Light Feature
- Solid State Circuit Boards are Designed at 7.7 - 14.0 VDC
- 1004 Double Contact Plug, Straight Pins

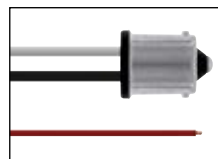

110127	LED 3rd Brake Light & Cargo Light	1 Pc. / Card
110217	Light Gasket	1 Pc. / Bulk

110217



Single Function White DRL

31513

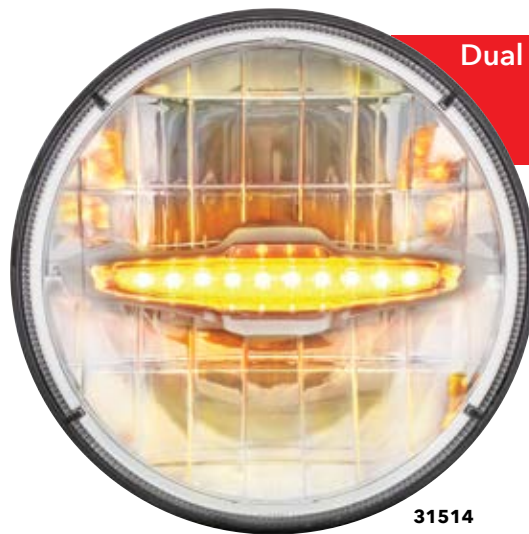
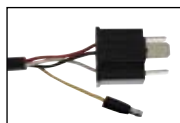

Dual Function Amber Signal Light

31514

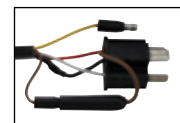

NEW COLOR PACKAGING

7" High Power LED Headlight with 10 LED Dual-Function Position Light Bar

- 3 High Power 7W LEDs for Exceptional Performance
- 900 Lumens Output on Low and 1,600 Lumens Output on High
- White Position Light Bar Can Be Wired as Day Time Running Light, Amber Position Light Bar Can Be Wired as Turn Signal
- Easy Installation, Fits OEM Housing, Plugs into Existing Wiring Harness
- DOT/SAE and FMVSS108 Headlight Compliant

Technical Specification	
Low Beam Application	High Beam Application
900 Lumens	1,600 Lumens
9V-33V DC Input	9V-33V DC Input FMVSS108
FMVSS108	

31513	w/Daytime Running Light	1 Pc. / Color Box
31514	w/Amber Auxiliary Light	1 Pc. / Color Box



NEW COLOR PACKAGING

5" x 7" LED Rectangular Light with LED Light Bar

- 7 High Power LED Headlight with 3 LED Position Light Bar
- High and Low Function
- Reinforced Aluminum Reflector
- Easy Installation, Fits OEM Housing, Plugs into Existing Wiring Harness
- IP 66 Rated, DOT/SAE Headlight Approved

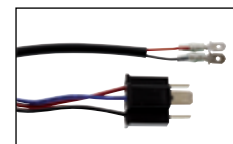

31120	1 Pc. / Color Box
--------------	-------------------

Technical Specification	
Low Beam Application	High Beam Application
1,680 Lumens	2,850 Lumens
12V-24V DC Input	12V-24V DC Input
1.15 AMPS	2.7 AMPS



Pistol Grip Shift Knob

- Pistol Grip Shift Knob
- Zinc Die-Cast, Available in Space Gray and Rose Gold
- Universal Hex Screw Mount Design (Mounting Hardware Included)

70745	Space Gray - 1 Pc. / Card
70746	Rose Gold - 1 Pc. / Card



1966-77 Ford Bronco Fresh Air Vent Box

- Driver Side Air Vent Box with Door for 1966-67 Ford Bronco
- Includes Foam Seals throughout the Box Like the Factory Original
- Fits Driver Side

110239	1 Pc. / Box
---------------	-------------



24 Red LED 4" "MIRAGE" Stop, Turn & Tail Light

- 24 LED 4" Round S/T/T "Mirage" Light
- 3 Contact Female Plug, Available in Color or Clear Lens
- DOT/SAE Approved
- Recommended Plug: Item# 34212/34216

36652B	Red LED/Red Lens - 1 Pc. / Bulk NEW
36652	Red LED/Red Lens - 1 Pc. / Card
36654B	Red LED/Clear Lens - 1 Pc. / Bulk NEW
36654	Red LED/Clear Lens - 1 Pc. / Card



9 Red LED 2" "MIRAGE" Clearance / Marker Light

- 2 Contact Female Plug, Available in Color or Clear Lens
- DOT/SAE Approved
- Recommended Plug: Item# 34210

36525B	Red LED/Red Lens - 1 Pc. / Bulk NEW
36525	Red LED/Red Lens - 1 Pc. / Card
36527B	Red LED/Clear Lens - 1 Pc. / Bulk NEW
36527	Red LED/Clear Lens - 1 Pc. / Card



COMPETITION
SERIES

8 High Power LED Rectangular Work Light with Chrome Reflector

- Heavy Duty Die Cast Aluminum Housing, 1,200 Lumens
- Stainless Steel Mounting Bracket and Hardware
- Operates on 10V-32V, Draws 1.66 Amps at 12V
- 3 Years Warranty

1,200
LUMENS

3w X 8
HIGH POWER

IP-67
WATERPROOF

10v-32v
MULTIPLE VOLTAGE



36507 1 Pc. / Color Box

NEW COLOR PACKAGING



COMPETITION
SERIES

8 High Power LED Rectangular Work Light with Projector Lens

- Heavy Duty Die Cast Aluminum Housing, 1,200 Lumens
- Stainless Steel Mounting Bracket and Hardware
- Operates on 10V-32V, Draws 1.66 Amps at 12V
- 3 Years Warranty

1,200
LUMENS

3w X 8
HIGH POWER

IP-67
WATERPROOF

10v-32v
MULTIPLE VOLTAGE



36508 1 Pc. / Color Box

NEW COLOR PACKAGING



NEW ITEMS

DECEMBER 2017



WIDE ANGLE OPTICS



Available with LED Turn Signal

Mustang LED Mirror

1967-68 Ford Mustang Exterior Mirror

- Fits Original 1967-68 Ford Mustang
- Chrome Die Cast Mirror Arm and Head
- Convex Mirror for Wider Viewing on Right Hand Mirror
- Available with Auxiliary LED Turn Signal Arrow on Passenger Side
- Mounting Bracket Mounting Pad, and Mounting Screws Included



Hardware Included



NEW COLOR PACKAGING

F676801	Fits L/H & R/H	1 Pc. / Box
F676802	L/H w/LED Turn Signal	1 Pc. / Color Box
F676803	R/H w/Convex Mirror	1 Pc. / Color Box
F676804	R/H w/Convex Mirror & LED Turn Signal	1 Pc. / Color Box



**1967-72 Chevy & GMC Suburban & Fleetside
61 Red LED Tail Light Circuit Board**

- Super Bright LED Circuit Board Installs Behind Existing Lens
- Dual Function with Tail Light & Bright Stop/Turn Signal
- Easy Electrical Connection with 1157 Plug, No Modification to Vehicle
- Recommend Upgrade Under Dash Flasher to 90652 LED Flasher

110126	LED Tail Light Insert Board - 1 Pc. / Card
C677209	Tail Light Lens - 1 Pc. / Bag
C677207	Tail Light Housing - 1 Pc. / Box
110215	Tail Light Gasket - 1Pair / Bag



1932-36 Ford Roadster & Phaeton Windshield Cone, Polished Stainless Steel

- Highly Polished Investment Cast 304 Stainless Steel
- Fits All 1932-36 Ford Open Cars
- Sold Each

A6017SS 1 Pc. / Bag



1966-77 Ford Bronco Wiper Arm & Blade Kit, Polished Stainless Steel

- Perfect Upgrade for Classic 1966-77 Ford Broncos
- Polished Stainless Steel Wiper Arms with Chrome Plated Shaft Mounts
- Kit Includes Two Wiper Arms and Two 12" Wiper Blades

110299 1 Pair / Card



31201



31202

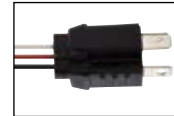

8 High Power LED 5 3/4" Headlight

- 1,020 Lumens Output on Low and 1,600 Lumens Output on High
- Replaces H5001 and H5006 Bulb
- Easy Installation, Fits OEM Housing, Plugs into Existing Wiring Harness
- DOT/SAE and FMVSS108 Headlight Compliant

31201 Silver - 1 Pc. / Card

31202 Black - 1 Pc. / Card

Technical Specification	
Low Beam Application	High Beam Application
12.8V DC Input	12.8V DC Input
0.9 Amps / 12 Watt	1.5 Amps / 20 Watt
FMVSS 108	FMVSS 108



1939 Chevy Glass Tail Light Lens with Blue Dot

- Red Glass Lens with Glass Blue Dot and Chrome Ring

C3901-1 1 Pc. / Box



Grille Tail Light Bezel for 1933 - 36 Ford Tail Lights

- Great Look For Hot Rods, Rat Rods and Chopper Motorcycles
- Easy Installation, Simply Replaces the Original Tail Light Rim
- Available in Chrome or Gloss Black

110427 Chrome - 1 Pc. / Box

110428 Gloss Black - 1 Pc. / Box

1933-36 Ford Tail Light Assembly with Grille Bezel

- Great Look For Hot Rods, Rat Rods, Motorcycles
- Die Cast Metal Grille Bezel Protects Tail Light Lens
- Complete 12 Volt Tail Light with Authentic Style Cloth Braided Wires
- Lefthand Tail Light Has License Plate Illuminator Lens
- Sold Each



110656



110658

Incandescent Tail Light with Glass Lens

Item #	Style	Rim	Application	Pack
110656	Tail Light w/License Light	Chrome	L/H	1 Pc./Box
110657	Tail Light	Chrome	R/H	1 Pc./Box
110658	Tail Light w/License Light	Black	L/H	1 Pc./Box
110659	Tail Light	Black	R/H	1 Pc./Box



110660



110662

LED Tail Light with Polycarbonate Lens

Item #	LEDS	LENS	Rim	Application	Pack
110660	17 Red 4 White	Red	Chrome	L/H	1 Pc./Box
110661	17 Red	Red	Chrome	R/H	1 Pc./Box
110662	17 Red 4 White	Red	Black	L/H	1 Pc./Box
110663	17 Red	Red	Black	R/H	1 Pc./Box

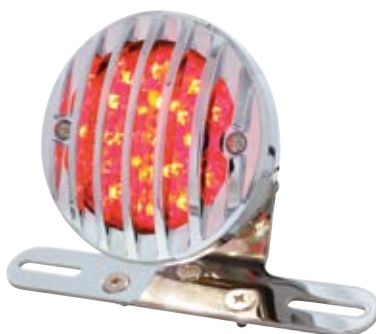

86858



86859



86860



86861

Motorcycle LED Rear Fender Tail Light with Grille Bezel

- Great Look for Any Chopper, Bobber, and Cafe Racer
- Die Cast Metal Grille Bezel Protects Tail Light Lens
- Complete LED 12 Volt Tail Light with LED License Plate Illuminator Lens
- Design Is Based on the Iconic 1933-36 Ford Tail Light
- Sold Each

Custom Motorcycle Products



LED Tail Light with Polycarbonate Lens

Item #	Style	Rim	Bracket	Pack
86858	Red LED Lens	Chrome	Chrome	1 Pc./Box
86859	Red LED Lens	Black	Black	1 Pc./Box
86860	Smoke Lens	Chrome	Chrome	1 Pc./Box
86861	Smoke Lens	Black	Black	1 Pc./Box

Custom Motorcycle Products



86850



86851



86852



86853

Motorcycle LED "Bobber" Style Horizontal Tail Light with Grille Bezel

- Great Look for Any Chopper, Bobber, and Cafe Racer
- Die Cast Metal Grille Bezel Protects Tail Light Lens
- Complete LED 12 Volt Tail Light with LED License Plate Illuminator Lens
- Design Is Based on the Iconic 1933-36 Ford Tail Light
- Sold Each

LED Tail Light with Polycarbonate Lens

Item #	Style	Rim	Bracket	Pack
86850	Red LED Lens	Chrome	Chrome	1 Pc./Box
86851	Red LED Lens	Black	Black	1 Pc./Box
86852	Smoke Lens	Chrome	Chrome	1 Pc./Box
86853	Smoke Lens	Black	Black	1 Pc./Box

Custom Motorcycle Products



86854



86855



86856



86857

Motorcycle LED "Bobber" Style Vertical Tail Light with Grille Bezel

- Great Look for Any Chopper, Bobber, and Cafe Racer
- Die Cast Metal Grille Bezel Protects Tail Light Lens
- Complete LED 12 Volt Tail Light with LED License Plate Illuminator Lens
- Design Is Based on the Iconic 1933-36 Ford Tail Light
- Sold Each

LED Tail Light with Polycarbonate Lens

Item #	Style	Rim	Bracket	Pack
86854	Red LED Lens	Chrome	Chrome	1 Pc./Box
86855	Red LED Lens	Black	Black	1 Pc./Box
86856	Smoke Lens	Chrome	Chrome	1 Pc./Box
86857	Smoke Lens	Black	Black	1 Pc./Box

TERMS & CONDITIONS / ORDERING GUIDELINES / FREIGHT

IMPORTANT: PLEASE REVIEW CAREFULLY

New Accounts

Initial minimum buy-in is \$2,000 (or to be determined by United Pacific Industries, UPI hereafter). All initial orders must be prepaid in advance by Cashier's Check or VISA/MC. All new/potential accounts must complete a UPI "New Customer Info/Credit Form" and follow the Dealer Qualification Instructions. Upon completion of the credit application, approved accounts will be assigned payment terms of NET 30 Days (from invoice date). Accounts denied a credit line will be required to prepay in advance by Cashier's Check or VISA/MC.

Payment Terms:

Term Accounts#

Accounts with NET 30 Days terms are required to submit payment within the 30 days from the date of invoice. Acceptable forms of payment include checks, ACH (Automated Clearing House), or wire transfer.

A service charge of 1.5% per month will be imposed on invoices not paid within the 30 day term. Delinquent accounts will be required to pay Cash-In- Advance (CIA). Checks will be accepted but orders will not be released until the check is cleared by the bank. Past due invoices will delay current orders. Please check with UPI on your account status when placing an order.

Credit Cards

Accounts denied credit terms may pay by Visa or MasterCard. Credit card will be charged upon shipment. Credit card payments will not be accepted once an order has been shipped. UPI does not accept American Express or Discover card.

COD

A \$9.00 fee will be assessed per COD box for all FedEx/UPS COD shipments. Truck COD shipment fees are to be determined later by trucking company.

Returned Checks:

A \$30 NSF (Non Sufficient Fund) fee will be assessed on each incidence a check is returned to UPI.

ORDERING GUIDELINES

Placing Orders: New orders may be placed by any of the following methods

1. Fax: [888.986.6088](tel:888.986.6088)
2. E-mail: antique@upauto.com
3. Telephone: In order to minimize errors, customers are encouraged to submit their orders by fax or email. Telephone orders should be limited to smaller orders such as add-ons to orders already submitted and/or fill-ins occurring between larger restocking orders.

Changes to Orders:

Whenever possible, revisions to orders - additions or deletions of items - should also be submitted via fax or email to reduce the possibility of errors.

Additions/Deletion of items will only be accepted within 48 hours after the initial order date and/or before 12:00PM on the date of the shipment. Additions of items placed after the 48 hours time period will be considered a new order and adhere to a new order freight prepaid policy. Deletions of item cannot happen after the 48 hours time period and/or after 12:00PM on the date of the shipment. Please note additions and/or deletions of items will delay the shipment date.

Canceling Orders:

Cancellation of orders must be submitted via fax or email within 24 hours of the order date. If the order has already shipped it will be the customers responsibility to return the order at the customers own expense. A restocking fee may apply, please see "Return" policy for further detail.

Backorders:

Customers have the option of having their backorders shipped or canceled. UPI will notify customer as to availability of backorders and will be able to ship any backorder items customer still needs as part of their next stock order. UPI reserves the right to cancel backorders that are 6 months or older from the initial invoice date.

Minimum Order:

A minimum order of \$50.00 is required. Orders below \$50.00 will be assessed a minimum order fee of \$10.00.

Packaging:

A 10% service charge will be added to orders with special packaging or UPC barcoding requirements.

Lead Times:

Standard lead time for all United Pacific orders is 1-3 business days from the receipt of the purchase order. Larger orders may require a lead time of up to 5 business days. Transit time of 3-5 business days must be considered when placing orders. UPI cannot be responsible for delays in shipment after an order leaves our warehouse. UPI will work to resolve delays with freight forwarding firms, however, delays do arise from time to time due to weather and unforeseen circumstances beyond UPI's control. Express order are exempted; please view Freight/Shipping Policy for further detail.

Order Confirmation:

United Pacific will acknowledge receipt of orders by email/fax/ telephone within 1 business day of receipt. If confirmation is not received, please contact UPI to ensure your order was received.

FREIGHT

Prepaid Freight:

Stock orders between \$50 and \$999.99 (US Lower 48 States), **\$50 and \$2499.99 (Alaska and Hawaii)**, **\$50 and \$1499.99 (Canada)**, [all price net US\$], will be shipped FOB Long Beach, California. Stock orders of \$1,000 (US Lower 48 States), **\$2500 (Alaska and Hawaii)**, **\$1500 (Canada)**, [based on UPI current pricing], or more will be shipped Freight Prepaid Ground to a single location only. (See exception for Oversize Items*). Express Air orders, Special Net Pricing orders, and Special Quote Pricing orders are excluded. United Pacific reserves the right to select the carrier of our choice. Customers may select the carrier of their choice at their own expense, negotiated rates and insurance. If customers elect to choose their own freight carrier, orders will be shipped via FREIGHT COLLECT.

Oversize Item Freight Policy – Applies to 1932 Ford car & truck body shell assemblies, 1932 Ford car & truck body parts such as floor assembly, roof, door, fender, quarter panel, grille, bulk rail gutter, bulk roof tack strip, chassis & frame, wheels & tire, and any exceptionally large or heavy item.

1. Freight will be prepaid by United Pacific if the total order of all items exceeds \$4,000 (US Lower 48 States) or **\$5000 (Hawaii, Alaska and Canada)**, [all price net US\$]. There will not be additional charges for these items included on the order.
2. Freight will be prepaid by United Pacific if a customer orders a total of \$2,500 (US Lower 48 States) or **\$3500 (Hawaii, Alaska and Canada)**, [all price net US\$], of PB 379 fenders, 60" or longer exhaust, and/or 18"+ Longer Saddle Boxes only. If the order is below \$2,500 (US Lower 48 States) or **\$3500 (Hawaii, Alaska and Canada)**, United Pacific will add freight charges to the order for the oversize items.

Will Call Orders:

Will Call orders can be picked up 2 - 4 hours after placing the order. Customers should always call ahead to confirm when order will be ready to pick up.

SHIPPING POLICY / CLAIMS

IMPORTANT: PLEASE REVIEW CAREFULLY

SHIPPING POLICY

International Shipments:

Shipments to locations outside the continental United States will be shipped to the customer's shipping agent or broker within the continental United States in accordance with the US freight policy. International customers will be responsible for the duties and taxes of their respective country.

Express Orders:

All express orders, such as Next Day, Second Day, 3 Day Service & Will Call, must be faxed/emailed. Order confirmation will be faxed to the customer for final approval. If confirmation is not received, please contact UPI to ensure your order was received. Customers are required to sign off on express orders and fax confirmation back to UPI. Cut off for express order is 12:00PM. Express orders received after 12:00PM may or may not ship the same day. Please call UPI to confirm projected shipping date or will call time.

Due to the high cost of express shipments, customer may request UPI to call to confirm freight charges. If customer does not request confirmation, UPI will ship the express order.

Drop Shipments:

All drop shipment orders will be assessed a 5% processing fee. Drop shipment processing fee will be automatically added to the invoice without notice. All drop shipment orders must be faxed in. No freight allowance or prepaid freight will be permitted for any drop shipments, thus, all drop ship orders, regardless of order size, are FOB Long Beach, CA.

CLAIMS

General Policy:

All claims (Shortage, Mis-Shipped, Damage, Overage, Customer Error & Billing Error) must be submitted to UPI within 3 business days of the receipt of shipment. Claims submitted beyond 3 business days of the receipt of shipment will be voided by UPI.

On all shipments, the person who signs and receives the shipment is responsible for noting on the Bill of Lading, in writing, whether any boxes arrived damaged or shorted. Failure to do so will void all claim rights between all parties. UPI will have no recourse against the trucking company if customer does not note any damages or shortages on the Bill of Lading.

The customers receiving department must count and sign for the exact number of boxes received. Failure to follow the above instructions will void all claim rights between all parties.

Shortages / Mis-Ships / Damages

While UPI strives to fill every order with 100% accuracy, on occasion an item may get shipped in error or get damaged during shipping. In the event this occurs, please follow the process below. Note: This type of claim must be reported to UPI within three (3) business days of receiving the order.

1. Contact the United Pacific office to initiate the claim. To make it easy for you we have two acceptable methods for requesting the claim:

- By e-mail : returns@upauto.com
- By fax : [888.986.6088](tel:888.986.6088)

* **Note: To ensure you receive a timely credit, we cannot accept claim requests by phone.**

2. You will be required to provide the following information:

- Your business name
- Contact name and telephone number (in case we have questions)
- Date the order was received
- A copy of the Packing List / Invoice noting the item number and quantity that was shipped in error or damaged during shipping.
- Special instructions you have for us.

3. UPI will send a return label so you can ship the items back.

4. Once we receive the miss-shipped/damaged item(s) a credit will be issued to your account on the next billing cycle.

5. Shortages will be credit to the Customers' account, unless customer would like the shortages replaced.

Overages:

UPI strives to provide our customers with the best customer service and products, in turn we would greatly appreciate any help from customer in notifying UPI of any shipping overages. Customers will be offered the option of retaining the merchandise or returning the merchandise to UPI at UPI's expense. If the items are to be returned, an RMA number and return shipping label will be provided.

Customer Errors:

Any item or quantity ordered in error by the customer may be returned by contacting UPI for a RMA No.

1. To make it easy for you we have two acceptable methods for requesting the RMA:

- By e-mail: returns@upauto.com
- By fax: [888.986.5988](tel:888.986.5988)

* **Note: To ensure you receive a timely RMA credit, we cannot accept RMA requests by phone.**

2. You will be required to provide the following information.

- * Your business name
- * Contact name and telephone number (in case we have questions)
- * A list of the items number and quantity ordered in error
- * Special instructions you have for us

3. UPI will review the request to ensure the products are within the return period.

4. Once we have validated the request, United Pacific will issue an RMA number to the customer. In issuing the RMA approval, the following conditions will apply :

- Returned items are subject to a 20% re-stocking fee.
- Return shipping costs are the responsibility of the customer.
- Items must not have any retail/price sticker on exterior packaging or they will be returned to the customer at customer's expense and no credit given.
- Items must be in good condition with original packaging intact or they will be returned to the customer at customer's expense and no credit given.
- Allow up to 30 days for the credit to be issued from the time the returned items are received.

Billing Errors:

Billing errors should be reported to UPI within 3 business days of invoice receipt. Customers are asked to provide the invoice number, part number, and quantities in question. Once verified, UPI will issue a credit or an invoice for the difference in billing error.

WARRANTY POLICY / RETURNS

IMPORTANT: PLEASE REVIEW CAREFULLY

WARRANTY POLICY

General Policy:

UPI offers a NO HASSLE WARRANTY RETURN policy to all our customers. Warranty claims can only be submitted through an authorized UPI Distributor. UPI warranty is not transferable and applies to the original installation and purchase only. In no event shall UPI be liable for incidental or consequential damages, nor shall UPI be liable for any claims or damages arising out of or connected with the UPI warranty exceed the purchase price of the products. There are no warranties, expressed or implied (including any warranty of merchantability or fitness) that extend beyond this warranty. The warranty does not apply to costs associated with the loss of use of the product, loss of time, inconvenience, commercial loss, incidental or consequential damages. UPI reserves the right to alter the designs of products without assuming any obligation to modify previously manufactured products and will only replace warranted products with redesigned products.

Warranty does not apply to merchandise that has been drilled, cut, welded, modified in any way or installed contrary to normal installation and usage. In addition, UPI cannot be held liable for damages caused by road hazards, accidents, misuse, neglect, abuse or corrosive environments including acid washes and highway snow/ice chemicals which can cause discoloration and corrosion in aluminum, chrome, stainless steel and light products. UPI reserves the right to credit returned merchandise at the initial purchase price or at the current selling price, which price ever is lower.

Aluminum / Chrome / Stainless Steel Products:

All aluminum, chrome, and stainless steel products carry a limited 6 month warranty (from invoice date) against defects in material or workmanship.

Lighting Products:

Incandescent

All incandescent lighting products carry a limited 12 month warranty (from invoice date) against defects in material or workmanship. The limited 12 month warranty does not apply to several applications, such as, buses, construction equipment, and off road vehicles.

LED

All LED lighting products carry a specific Limited Warranty (from invoice date) against defects in material or workmanship.

- LED with vehicle specific application is limited lifetime warranty to an original purchaser with receipt. Examples of lifetime warranty product: CTL5720LED CTL5720LED for 1957 Chevy, FTL3201LED-L for 1932 Ford.
- LED Marker, 2", 2-1/2", 4", 7", Oval & Square Lights - Varies from 2 years to 10 years to Limited Lifetime, depending on specific item. The housing, bezel or mounting base on any light made from Chrome/Stainless carries a 6 month limited warranty.
- LED Cab Lights and Kits, Double/Single Stud Turn Signal and PB/KW/FL/VL or non-make Turn Signals and any/all Strip Lights - Varies from 2 years to 10 years to Limited Lifetime, depending on specific item. The housing, bezel or mounting base on any light made from Chrome/Stainless carries a 6 month limited warranty.
- LED Beacon, Driving, Headlights, Work & Warning Lights - Varies from 6 months to 3 years. The housing, bezel or mounting base on any light made from Chrome/Stainless carries a 6 month limited warranty.
- All LED Accessory Lights (Honda, Stainless Steel Double/Single face Lights, Interior Lights, License Plate Lights, and any Accent Lights. The housing, bezel or mounting base on any light made from Chrome/Stainless carries a 6 month limited warranty.

RETURNS

General Policy:

All returns must be authorized by UPI. All return requests must be faxed or e-mailed (returns@upauto.com) A RMA number (Return Merchandise Authorization Number) will be provided. Returns not possessing a valid RMA number are subject to rejection and will be returned to sender at the customer's expense.

All customers are encouraged to use the Warranty RMA Claim Form.

Defective Goods / Warranty Return:

UPI offers our customers a No Hassle Warranty Return. Please follow the instructions below for requesting a RMA for defective goods:

1. If any warranty issues occur, simply contact the UPI for RMA number
To make it easy for you we have two acceptable methods for requesting the RMA:
 - By e-mail: returns@upauto.com
 - By fax: **888.986.5988**
 - **Note: To ensure you receive a timely RMA credit, we cannot accept RMA requests by phone.**
2. You will be required to provide the following information:
 - Your business name
 - Contact name and telephone number (in case we have questions)
 - A list of the defective item number and quantity with the nature/ reason of the defect
 - Special instructions you have for us
 - The enclosed fax form may be used for your convenience to request an RMA
3. UPI will review the request to ensure the products are within the stated warranty period.
4. Once we have validated the warranty items, a RMA confirmation, listing the items and cost will be faxed to the customer within 3 business days. UPI will process the credit to your account within 30 days.

Note: There will be no need to return the warranty product to us. However, from time to time, UPI may require some warranty products to be shipped back so we may analyze the cause of the failure. All warranty products that are required to be shipped back will be freight prepaid by UPI.

Stock Return

United Pacific Industries encourages all customers to regularly monitor the sales volume and stock level of their inventory items. As sales trends may slow the movement of specific items, our hope is that those items are featured as "close-out specials" as to minimize stock returns. We also understand that the customer, from time to time, may accumulate over-stock items and desire to return those. Therefore, we have adopted the following policy below.

NOTE:

- Items must have been purchased by the dealer requesting the stock return.
 - Items must have been purchased within the preceding 12 months.
 - Items that have been discontinued will not be considered for return.
1. Contact the United Pacific office for RMA number We have 2 acceptable methods for requesting the RMA:
By e-mail : returns@upauto.com
By fax : **888.986.6088**
***Note: To ensure you receive a timely RMA credit, we cannot accept RMA requests by phone.**

RETURNS / CATALOGS / DISCLAIMER

IMPORTANT: PLEASE REVIEW CAREFULLY

2. You will be required to provide the following information:

- Your business name
- Contact name and telephone number (in case we have questions)
- A list of defective items: Item numbers and quantity of each
- Special instructions you have for us

3. Your claim will be reviewed within 5 business days and you will be contacted by your sales representative who will discuss solutions to liquidate these slow moving items.

4. In the event United Pacific and the customer agree to a credit in lieu of returning the items, this credit will be issued within 10 business days.

5. In the event items are returned by the customer, United Pacific will issue an RMA number to the customer. In issuing the RMA approval, the following conditions will apply:

- Returned items are subject to a 20% re-stocking fee.
- Return shipping costs are the responsibility of the customer.
- Items must not have any retail/price sticker on exterior packaging or they will be returned to the customer at customer's expense and no credit given.
- Items must be in good condition with original packaging intact or they will be returned to the customer at customer's expense and no credit given.
- Allow up to 30 days for the credit to be issued from the time the returned items are received.

6. Stock returns may be requested throughout the year and are subject to a maximum of 5% of prior year annual purchases.

Closeout/Discontinue Items:

UPI will not warranty or accept returns on Closeout/Discontinue items.

Procedure:

An inventory of the merchandise being returned must accompany each return. The RMA number should be prominently displayed on each carton/box.

All Returns must be returned freight prepaid.

Ship Returns to:

United Pacific Industries
Attn: Returns Department
3788 E. Conant St.
Long Beach, CA 90808

RMA's:

Outstanding RMA's will be automatically canceled if not used within 30 days of issuance.

CATALOGS

General Policy:

UPI will send a set of catalogs and price lists upon the arrival any new catalogs and price list. Included in the mailing will be a Catalog Order Form in which customers can request additional copies.

Catalog/CD Request:

UPI provides additional catalogs/CD's to our customers free of charge. Customer must submit their request on a UPI Catalog Order Form or add the request to their regular restocking order. Requests for additional catalogs/CD's should be submitted along with the regular restocking orders to avoid additional freight charges. Due to the availability of catalogs/CD's, customer's request may be limited to certain quantity. Catalogs/CD's will be shipped along with the customers' order. Customer may request the catalogs be shipped separately, but customer will be responsible for the freight charge.

Picture Request

All UPI item pictures are taken professionally by our marketing department. Item pictures can be downloaded online at www.upauto.com. Item pictures not posted online can be requested by sending an email to [e-mail graphic@upauto.com](mailto:graphic@upauto.com). All picture requests must state the item no and the format of the picture file, i.e jpeg or high resolution. UPI has over 20,000 SKU's and therefore does not have a CD with all the items.

DISCLAIMER

United Pacific Industries reserves the right to amend or update our Policies & Procedures without notice.

United Pacific Industries is not responsible for typographical, product information or print errors. Specifications on this catalog may be changed without advance notice. Products may look different from those in the photos on this catalog due to printing quality.

RMA FORM SAMPLE



UNITED PACIFIC INDUSTRIES, INC.
3788 E. CONANT ST.
LONG BEACH, CA 90808
DIRECT: (562) 421-3888
TOLL FREE: (800) 790-6988
TOLL FREE FAX: (888) 966-5988

DEFECTIVE GOODS / WARRANTY CLAIM FORM

Date: _____
Company Name: _____
Address: _____
City, State, Zip: _____
Contact Name: _____
Phone Number: _____
Fax Number: _____
E-mail: _____

List defective items below:

Item #	Quantity	Description	Reason for Defect	Date sold to Customer
1				
2				
3				
4				
5				
6				
7				
8				
9				
10				

Any special notes / instructions for United Pacific (list here):

File your claim at:
by email - returns@upauto.com
by fax - (888) 966-5988

Note: we cannot accept any phone request

Internal Use Only

Date Received: _____ Final RMA
RMA Approval Date: _____ Credit Amount: _____
RMA Number: _____ Approved By: _____

PRODUCT INDEX

ITEM#	PAGE#	ITEM#	PAGE#	ITEM#	PAGE#	ITEM#	PAGE#
22974	30	36615	29	70711	28	110180	25
22975	30	36616	29	70745	50	110181	25
22976	30	36646	18	70746	50	110182	44
22977	30	36647	18	70801	18	110183	44
31120	49	36648	18	70802	18	110200	34
31169	43	36649	18	70803	17	110201	34
31201	54	36652	50	70804	17	110202	34
31202	54	36652B	50	86850	56	110213	12
31237	14	36654	50	86851	56	110214	12
31238	14, 43	36654B	50	86852	56	110215	22, 53
31496	35	36781	14	86853	56	110217	39, 48
31513	49	36782	14	86854	56	110227	25
31514	49	36783	14	86855	56	110228	24
31519	22	36827B	20	86856	56	110229	4
32778	20	36832BRK	29	86857	56	110230	4
34122	35	36838	15	86858	55	110231	31
34217B	15	36839	15	86859	55	110235	5
36473	42	36840	15	86860	55	110236	5
36475	42	36841	15	86861	55	110237	5
36481	42	36842	15	88300	17	110238	5
36483	42	36888	8	88301	17	110239	50
36496	42	39397	20	88302	17	110240	5
36497	42	39744	42	88303	17	110241	5
36498	42	39746	42	88304	17	110242	5
36507	51	39781	42	90322	20	110243	6
36508	51	46101	41	90323	20	110244	6
36509	46	46153	8	90652	27	110245	6
36510	35	49998	22	90656	33	110246	13
36514	15	49999	19, 22	90661	46	110247	13
36514B	15	50033	35	90800	16	110248	7
36515	15	50034	30	90801	16	110249	12
36515B	15	50037	30	90802	16	110250	12
36516	18	50038	30	90803	16	110266	21
36517B	8	50047	13	90808	16	110267	31
36518B	8	50065	19	90809	16	110269	11
36519B	8	50109	19	90810	16	110270	11
36520B	8	50112	8	95000	19	110271	4
36521B	8	50113	19	95001	19	110272	4
36522	7	50114	35	99087	22	110273	32
36523	7	50115	30	99098	22	110274	32
36525	50	50116	30	99099	33	110275	5
36525B	50	50117	30	110005	34	110276	5
36527	50	50118	41	110105	1	110277	4
36527B	50	50119	43	110106	10	110278	4
36528	29	50124	41	110107	1	110279	6
36529	29	50128	41	110108	1	110280	33
36530	29	50129	41	110109	1	110281	33
36531	29	52000B	13	110124	13	110282	6
36532	29	52001B	13	110126	53	110283	21
36607	47	52002B	13	110127	48	110284	25
36608	47	52003B	13	110129	7	110285	25
36609	47	52004B	13	110155	44	110286	7
36610	47	52005B	13	110156	44	110287	10
36611	29	52006B	13	110157	44	110288	11
36612	29	52007B	13	110158	44	110290	2
36613	29	70646	28	110179	25	110291	2
36614	29	70657	28				

ITEM#	PAGE#	ITEM#	PAGE#	ITEM#	PAGE#
110299	53	110437	17	CTL7387LED-L	27
110318	40	110438	38	CTL7387LED-R	27
110319	40	110439	38	F676801	52
110320	24	110440	45	F676802	52
110321	3	110441	37	F676803	52
110322	3	110443	39	F676804	52
110323	3	110582	34		
110324	3	110587	43		
110325	3	110656	55		
110326	3	110657	55		
110327	32	110658	55		
110328	32	110659	55		
110329	37	110660	55		
110330	32	110661	55		
110336	23	110662	55		
110339	25	110663	55		
110340	11, 25	122511	26		
110341	33	122551	26		
110342	12	122601	26		
110343	34	122641	26		
110349	23	122671	26		
110350	23	190601	40		
110351	23	190602	40		
110352	32	A1035	34		
110353	32	A1039-12VRL	26		
110354	24	A1040-12VRL	26		
110355	24	A6017SS	53		
110356	21	A8001	33		
110357	21	B20012-TPS	22		
110358	39	B20133	28		
110385	32	B20302	28		
110387	38	B20355	2		
110388	33, 38	B20356	2		
110389	11	B20401	36		
110391	10	B20409	28		
110392	10	B21012-TPS	2		
110393	33	B21015	9		
110394	24	B21016	9		
110395	24	B21022	31		
110397	23	B21023	31		
110398	23	B21024	31		
110399	32	B21025	31		
110400	33	B21026	31		
110401	33	B24101	26		
110402	26	B24101SS	26		
110406	26	C3901-1	54		
110407	26	C5055	9		
110409	26	C5056	9		
110424	40	C5059	9		
110427	54	C607112	18		
110428	54	C677207	53		
110431	31	C677209	22, 53		
110432	31	C738703	27		
110433	31	C738710	36		
110434	31	C738710-CVX	36		
110435	45	C738710-CVXLED	36		
110436	17	C738710-LED	36		



Get your parts. Build your passion.





2017 Antique New Item Product Collection

UPauto.com

3788 E. Conant St., Long Beach, CA 90808 | t: 866.327.5288 | f: 888.986.6088

ANF1217

2017 NEW ITEMS PRODUCT
FLYER SUPPLEMENT



710270056248