



United Pacific

1947-1987 CHEVY & GMC





United Pacific

As leaders in the industry, it is our mission to ensure the best fitment and function when it comes to your custom build. We understand the rigors and stresses that our products are subjected to on the road, so we partner with top manufacturing facilities that conform to our strict requirements and must perform quality assurance tests. It is our duty to provide our customers with products of superior quality and reliability.

HOW TO ORDER

To order from United Pacific Industries, you must be an authorized dealer, distributor or OEM. If you are not authorized to stock and sell United Pacific products, you must order through an authorized dealer. Please call 866.327.5288 for more information.

CONTACT US

 8 am - 4:30 pm PST

 866.327.5288 / 562.425.5588

 888.986.6088 / 562.425.3632

 Antique@upauto.com

 UPauto.com

 3788 E. Conant St., Long Beach, CA 90808

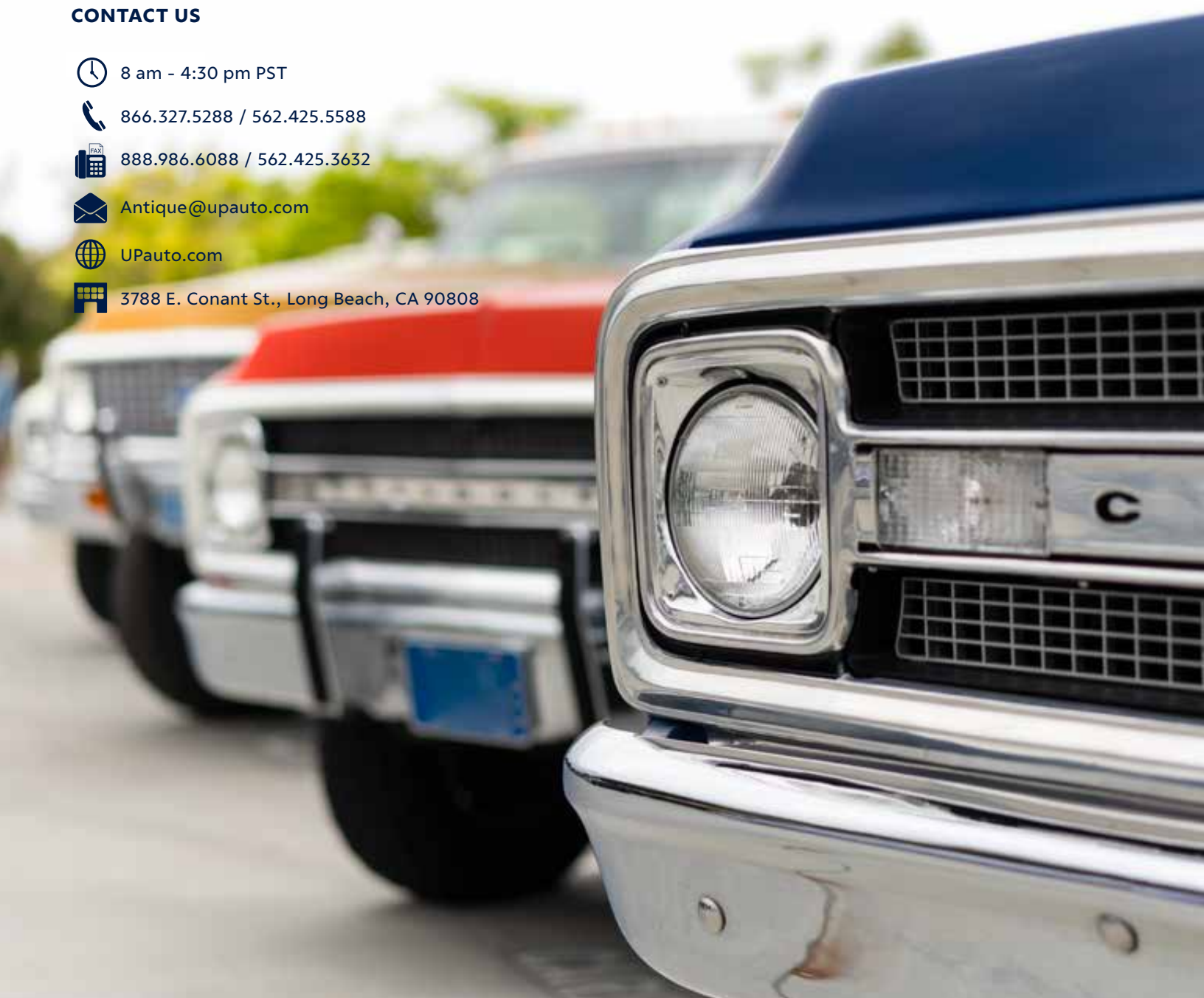

QUALITY

With over 30 years of experience in the automotive aftermarket industry, United Pacific Industries understands the rigors and stresses that our products are subjected to on the road. It is our mission to provide our customers with products of superior quality and reliability. In achieving this goal, United Pacific only partners with manufacturing facilities that conforms to our quality control requirements and standards. Our manufacturing partners meet or exceed ISO-9001 requirements. In addition, United Pacific's manufacturing partners must be equipped on site to perform the following quality assurance tests and maintain a track record of consistent quality and low product failure rate.

- Aging Test
- Air Tight Test
- Dust Test
- Flux Test
- Photometric Test
- Pull Force Test
- Rain Test
- Salt Spray Test
- Shock Test
- Temperature Test
- Humidity Test
- Vibration Test

Furthermore, our internal quality control structure allows us to function as the final quality control station prior to shipping. With the assistance of 3D computer technology, United Pacific can adhere to strict quality control standards during prototype creation and the production process. Our engineers and technicians perform a battery of tests to ensure that our products meet the demands of today's drivers and our goal to be first in quality.

INNOVATION

Known as the leader in innovation, United Pacific is dedicated to be the first to bring new and exciting products to the market. United Pacific's global expertise allows us to search the globe for new ideas and concepts. Not only do we search the globe for new products, United Pacific invest a significant amount of resources into our own research and development efforts. With the assistance of advance 3D scanning technology, our engineers and designers can acquire accurate and precise data in seconds. The 3D data allows United Pacific to verify designs, perform quality assurance tests, and reverse engineer with unprecedented speed and accuracy. Digital inspection contributes to the early detection of shape problems, provides rapid feedback on design, and eliminates unnecessary work in downstream processes. Our rapid prototyping facility permits us to have a concept-to-shelf time of less than 5 months. In addition, United Pacific's 3D printing capabilities permit our designers to have physical models of their design concepts in hours. The physical models allow our designers and marketing staff to evaluate and test the viability of different design ideas. Our rapid prototyping facility allow United Pacific to compress design cycles, improve manufacturing planning, shorten concept-to-shelf time, most importantly, generate new and innovative products.

DESIGN

Located near some of the nation's most progressive automotive design centers, United Pacific established the UP Design Studio in 2002 to consolidate our position as the design leader in the automotive industry. UP Design Studio utilizes the latest generation of computer aided design (CAD) and studio/graphic software. The design studio is equipped with the newest computers and rapid prototyping systems. In addition, UP Design Studio is staffed by graduates from the nation's most prestigious design colleges. Unlike our competitors, United Pacific's design and manufacturing capabilities mean that we carry more new and original items than our competitors. The establishment of the design studio will enable us to generate even more new products with significant shorter concept-to-shelf time. The reduction in development cost mean that we can develop products utilizing design based development processes. Design based product development allows United Pacific to create new product concepts based on designs incorporating driver demands and needs instead of economic considerations. United Pacific's emphasis on design distinguishes and positions us ahead of our competitors.



WARRANTY

With LED (Light Emitting Diodes) rated at 100,000 hours of operation and solid-state construction, United Pacific's LED lights are extremely reliable and durable. Purchase with confidence, United Pacific offers a complete line of LED lighting products with extended or limited lifetime warranties. Please see the warranty policy page for more details.

INVENTORY AND SHIPPING

United Pacific carries over 20,000 items in our California distribution center. No other company in the heavy duty trucking industry can match United Pacific in the variety and range of in-stock inventories. With an order fill rate of over 98.5%, United Pacific is the largest and most reliable supplier in the industry. Our shipping department ships 96.8% of all orders within 24 hours and 98.9% within 48 hours. United Pacific's vast inventory and prompt shipping has made United Pacific the only source for our customer's chrome and lighting needs.



HARD AT WORK FOR THE ENVIRONMENT



United Pacific
132,000 sq ft

Distribution Center
Long Beach, CA

100%

reduction in potable water used for landscaping

40%

reduction in total energy use due to high-efficiency mechanical and lighting systems

82%

of construction waste was diverted from landfills

LEED ACCOMPLISHMENTS

Sustainable Sites

- On-site bicycle storage, showers and changing areas for company employees.
- Preferred parking for low-emitting, fuel-efficient and carpool vehicles.
- Stormwater is infiltrated on-site and treated to remove contaminants to reduce environmental impact on local waterways.

Water Efficiency

- In addition to using reclaimed water, drought-tolerant plants and a high-efficiency irrigation system were installed to reduce the use of potable water for irrigation by 100%.

Energy and Atmosphere

- Efficient HVAC equipment and a lighting system with daylight controls reduces energy consumption by over 30%.
- Enhanced commission verifies that the building's energy and water-related systems are performing as intended by the initial design.

Indoor Environmental Quality

- Building ventilation systems was designed to provide enhanced levels of fresh outside air to building occupants.
- Interior finishes (plants, sealants, adhesives, coatings, carpet systems and composite wood) were selected with low levels of volatile organic compounds (VOCs) to reduce indoor air contamination.



TABLE OF CONTENTS

<u>Week To Wicked</u>	<u>7-8</u>	<u>Glove Box / Hand Brake Covers / Pedals</u>	<u>95</u>
<u>Shortbed Body Panels</u>	<u>9-10</u>	<u>AC Vents / Defrost Ducts</u>	<u>96</u>
<u>Headlights</u>	<u>11-24</u>	<u>Vent Windows / Glass Channels</u>	<u>97-98</u>
<u>Headlight Bulbs / Adapters / Relay</u>	<u>25</u>	<u>Door Handles</u>	<u>99-100</u>
<u>LED Control Module</u>	<u>26</u>	<u>Window Regulators</u>	<u>101</u>
<u>Misc. Headlight Parts</u>	<u>27-28</u>	<u>Door Sill / Door Latch Relay</u>	<u>102</u>
<u>Headlight Visors</u>	<u>29-30</u>	<u>Door Latches / Striker Plates</u>	<u>103-104</u>
<u>Tail Lights</u>	<u>31-43</u>	<u>Running Boards / Bedside Steps</u>	<u>105-106</u>
<u>Tail Light Bezels</u>	<u>44</u>	<u>Gas Caps</u>	<u>107</u>
<u>Tail Light Housings / Brackets</u>	<u>45</u>	<u>Fuel Tanks</u>	<u>108</u>
<u>Tail Light Gasket / Backup Lights</u>	<u>46</u>	<u>Fuel Sending Units</u>	<u>109-110</u>
<u>Parking Lights</u>	<u>48-52</u>	<u>Hood Emblem</u>	<u>111</u>
<u>Parking Light Bezels / Gaskets</u>	<u>53-54</u>	<u>Hub Caps / Exhaust Deflector</u>	<u>112</u>
<u>Side Marker Lights</u>	<u>55-56</u>	<u>License Plate Frames</u>	<u>113-114</u>
<u>Misc. Lights</u>	<u>57-58</u>	<u>Horns / Compressor</u>	<u>115-116</u>
<u>License Light / Bracket w/ Light</u>	<u>59-60</u>	<u>Terms and Conditions</u>	<u>117-118</u>
<u>Bumpers</u>	<u>61-64</u>	<u>Warranty Policy / Returns</u>	<u>119-120</u>
<u>Grilles</u>	<u>65-66</u>	<u>Index</u>	<u>121-124</u>
<u>Hood Parts</u>	<u>67-68</u>		
<u>Battery Hold Downs / Trays Etc.</u>	<u>69-70</u>		
<u>Exterior Mirrors</u>	<u>71-78</u>		
<u>Wiper Blades / Arms</u>	<u>79-80</u>		
<u>Rear View Mirrors</u>	<u>81-84</u>		
<u>Gauge Packages</u>	<u>85-86</u>		
<u>Dash Knobs / Cables</u>	<u>87-88</u>		
<u>Switches / Shift knobs</u>	<u>89-90</u>		
<u>Steering Columns / Hub / Horn</u>	<u>91-92</u>		
<u>Steering Wheels</u>	<u>93-94</u>		





1947

CHEVY & GMC TRUCKS

1987

UNITED PACIFIC

WEEK TO WICKED 1971 CHEVY C10 BUILD



In the most recent installment of Week to Wicked presented by Classic Trucks Magazine, United Pacific and the team over at the MotorTrend Tech Center in Santa Ana, California, banded together to transform a stock 1971 Chevy C10 Pick-up truck to a WICKED street performance ride...in just ONE WEEK! The build started off with the usual wrenches and sparks flying as the guys stripped the truck down in preparation for the complete restoration. Things motored along as we raced towards the final days updating the build with a new suspension, drivetrain, brakes, and steering components, a fresh set of wheels and tires, and some interior redecorating. As we finally reached the finish line, it was time to fire up the C10's ZZ6 small-block. The engine came to life on the first crank leaving the crew excited for the test drive and of course, the obligatory burnout.

THANKS TO ALL THAT HELPED WITH THE BUILD



United Pacific Industries:

Sheetmetal, Lighting, Restoration Products

Classic Performance Products:

Presenting (Steering, Dual Adjustable Coilover Suspension, 6 Piston Modular Brakes, EFI Fuel Tank)

Covercraft:

Official Car Cover

Dakota Digital:

Official Gauges (HDX Series)

Holley Performance:

Dual Quad Terminator EFI, Exhaust (Hooker Blackheart) & Radiator (Frostbite)

Strange Engineering:

Strange Bolt-In Housing for 67-72 c10, 3.70 Ratio, 31 Spline Axles

Gandrud Chevrolet:

Crate Engine- ZZ6 Chevy Small Block 405 horsepower and 406 lb.-ft. of torque

Old Air Products:

Air Conditioning- Hurricane Bolt in kit

American Legend:

Wheels- Racer series wheels 18x8 Front, 18X9 Rear

Gearstar Transmission:

200-4R Transmission

Custom Auto Sound Mfg:

Official Product (Bluetooth Audio System)

American Autowire:

Official Product (Classic Update Series Wiring Harness)

Odyssey Battery/Ha B&M Sports:

Official Product (Performance Series AGM Battery)

Procar by Scat:

Official Product (Seats)

Yank Performance:

Torque Converter

SHORTBED BODY PANELS



1



Bedside exterior



Bedside interior

1968-72 Chevy & GMC Fleetside Truck

SHORTBED BEDSIDE PANELS

- Reproduced exactly like the original with high quality 20-gauge steel, stamped with all the original contour and detail
- Complete bedside, includes installed and spot welded 17 gauge inner liner
- Features 3/8-16 and 5/16-18 threads welded in between exterior steel panel and inner reinforcement
- Black EDP Coated
- Includes rubber tailgate bumpers
- Has side marker cutout for 1968-72, but can be used on 1967 if side marker is desired
- Packed in heavy-duty cardboard box

110829 | LH/Driver | 1Pc. / Box

110830 | RH/Passenger | 1Pc. / Box

UNITED PACIFIC BODY PANELS

United Pacific is the source for quality body panels for long bed to short bed conversions. By reverse engineering each panel with exact specifications and modern technology, we are able to create a complete replica of short bed C10 bedside, bed floor pan and tailgate panels. Our high-quality heavy steel panels are manufactured with mounting holes and feature our exclusive welded nut inserts for the wheel well, tailgate pivot trunnion, tailgate support and striker.

United Pacific's goal is to ensure that our parts have the best possible fit and make sure installation is a breeze. We are here to help the C10 community restore and rebuild the truck of their dreams.

Pre-welded wheel well nuts

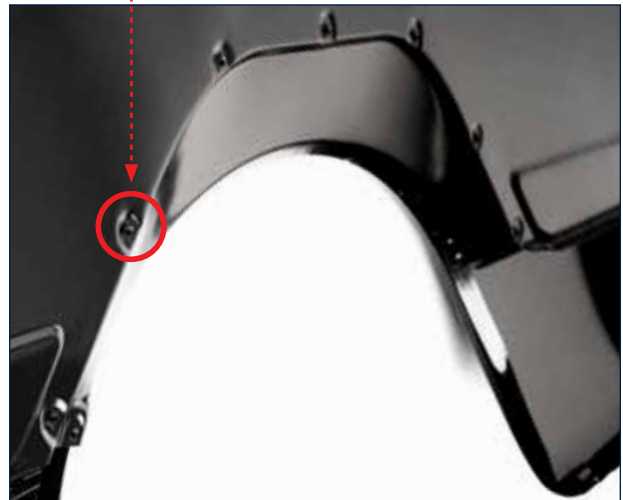

SHORTBED BODY PANELS

2

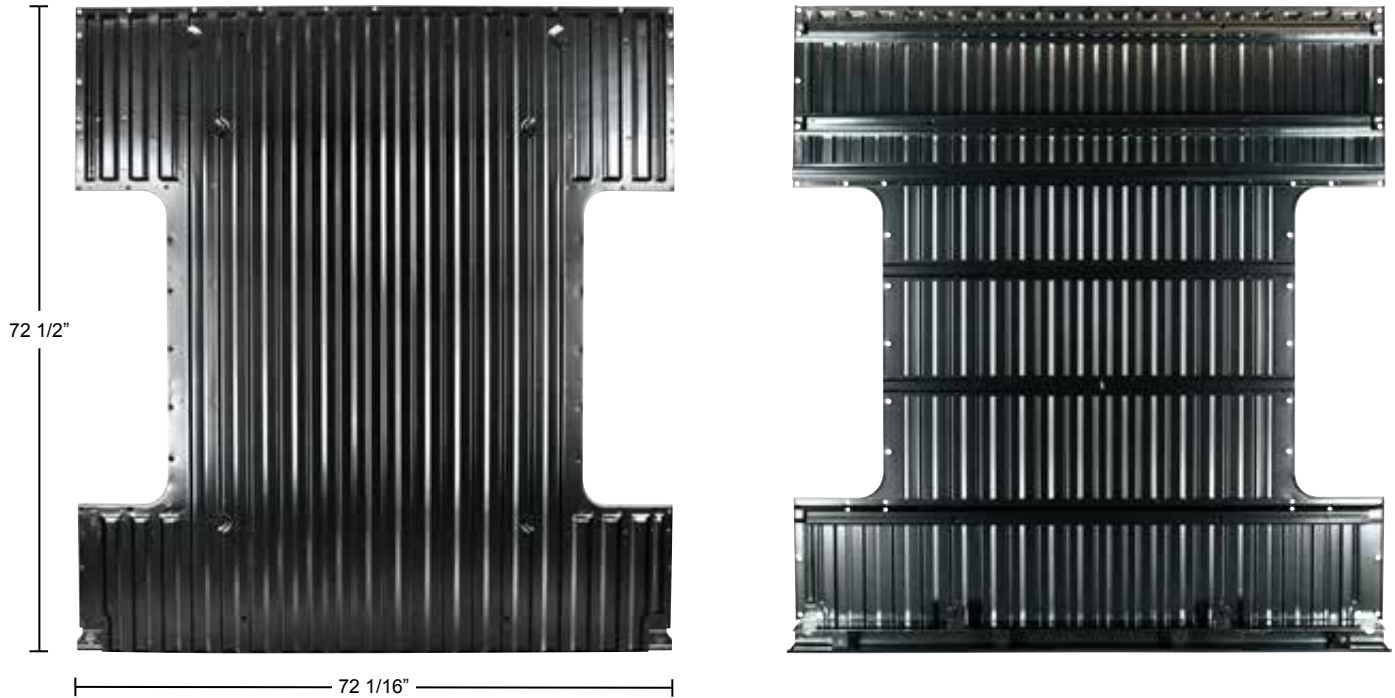

1967-72 Chevy & GMC Fleetside Shortbed Truck

6-1/2' BED FLOOR PAN

- 6-1/2' Bed Floor Pan For 1967-72 Chevy & GMC Truck Fleetside Shortbed
- Excellent stamped sheet metal reproduction with all of the original contour detail
- Quality 18 gauge floor panel with spot welded heavy 14 gauge crossmembers
- Features precision punched mounting holes for easy bed front, bed side, and wheel well installation
- Finished with black EDP protective coating

110839

3



1967-72 Chevy & GMC Fleetside Truck

TAILGATES

- Die stamped quality 17 gauge steel
- Precision cut latch handle pocket with mounting holes
- Two welded 5/16-18 nuts on each side for latch mounting
- Includes tailgate linkage posts and tailgate trunnion pockets
- Finish with black EDP protective coating to keep your new steel fresh and rust-free
- Official GM licensed for GMC lettering

110845 | Plain

110846 | Recessed Chevrolet Lettering

110847 | Recessed GMC Lettering

LED HEADLIGHTS



Universal

7" LED HEADLIGHT W/ POSITION LIGHT

- High power LED headlight with LED turn signal and position light bar
- Reinforced aluminum reflector with rugged anti-vibration construction
- Easy connection, fits OEM housing or fender, plugs into existing wiring harness, position light requires additional wiring
- DOT/SAE approved, sold individually

31458 | Amber LED Position Light Bar

31459 | White LED Position Light Bar



Universal

7" LED HEADLIGHT-BLACK

- 5 high power LED 7" headlight, Philips Lumileds
- Reinforced aluminum reflector with rugged anti-vibration construction
- Sold individually

31289



Universal

7" LED HEADLIGHT-CHROME

- 5 high power LED 7" headlight, Philips Lumileds
- Reinforced aluminum reflector with rugged anti-vibration construction
- DOT/SAE compliant, sold individually

31391

LED HEADLIGHTS



Universal

7" LED HEADLIGHT W/ POSITION LIGHT BAR

- High power LED headlight with 2 LED position light bar
- Dual function headlight with high and low beam
- Reinforced aluminum reflector with rugged anti-vibration construction
- Easy connection, fits OEM housing or fender, plugs into existing wiring harness, position light requires additional wiring
- DOT/SAE approved, sold individually

31200



Universal

7" LED HEADLIGHT W/ POSITION LIGHT BAR

- 3 high power LED headlight with 10 LED dual function position light bar
- 900 lumen output on low, 1,600 lumen output on high
- White position light bar can be wired as daytime running light and amber position light bar can be wired as turn signal
- Easy installation, fits OEM housing, plugs into existing wiring harness
- DOT/SAE approved, sold individually

31513 | White LED Position Light Bar

31514 | Amber LED Position Light Bar

LED HEADLIGHTS



LED HEADLIGHTS



Universal

7" LED CRYSTAL HEADLIGHT-CHROME

- 11 high power LED 7" headlight, impact resistant polycarbonate lens provides unparalleled protection from road hazards
- Die-cast aluminum housing provides maximum protection from the elements
- DOT/SAE compliant, sold individually

31355



Universal

7" LED PROJECTION HEADLIGHT W/ LED HALO

- 7" high power projection headlight with dual function LED halo ring
- Dual color white/amber auxiliary LED halo ring with amber automatic override feature
- Die-cast housing and polycarbonate lens provide maximum protection and durability
- Solid state design resists shock and vibration, IP67 weatherproof rating
- DOT/SAE compliant, sold individually

31496



Universal

7" LED HEADLIGHT

- 7" high power LED headlight
- Durable corrosion resistant polycarbonate lens & housing
- Solid state design resists shock and vibration, DOT/SAE headlight compliant
- Easy connection, fits OEM housing, plugs into existing wiring harness, position light requires additional wiring
- Low beam 500 lumens, high beam 950 lumens

31084

HEADLIGHTS W/ LED POSITION



Universal

7" CRYSTAL HEADLIGHT W/ LED HALO RING

- 7" crystal headlight with LED halo ring and 9007 bulb
- Reinforced aluminum reflector with rugged anti-vibration construction
- Sold individually

31284 | Amber LED Halo Ring

31285 | White LED Halo Ring



Universal

7" CRYSTAL HEADLIGHT W/ AUXILIARY LED

- High power LED 7" headlight with clear lens, 34 auxiliary LED
- Reinforced aluminum reflector with rugged anti-vibration construction
- H4/HB2/9003 halogen bulb: 12V 65/55W, replaces H6017/H6024
- HB2/9003 DOT/SAE code: DOT SAE-HR1-01
- DOT/SAE compliant, sold individually

31378 | Amber Auxiliary LED

31379 | White Auxiliary LED

Universal

7" CRYSTAL HEADLIGHT W/ LED POSITION LT

- 7" crystal headlight with 6 hi/low function amber LED position lights
- Reinforced aluminum reflector with rugged anti-vibration construction
- DOT/SAE Hr 15, LED for auxiliary/utility purposes, sold individually
- Includes 9007 halogen bulb and seal beam/H4 plug adapter
- 12V, dual function auxiliary LEDs have three wire hookup

31247



HEADLIGHTS



Universal

7" SEALED BEAM HEADLIGHT

- 7" regular 6014 sealed beam headlight
- Replaces H6014/H6024, high and low beam

30356



Universal

7" CRYSTAL HEADLIGHT

- Reinforced multi-surfaced, aluminum reflector
- Rugged anti-vibration construction
- Sylvania halogen bulb: H4/HB2 12V 65/55W
- Replaces H6014/H6024, SAE & ECE approved

31387



Universal

7" GLASS LENS HEADLIGHT

- 7" round headlight with glass lens & replaceable H4 bulb
- Replaces H6014/H6024, high and low beam, H4 bulb included

A5023-3



Universal

7" SEALED BEAM HEADLIGHT

- 7" regular 6014 sealed beam headlight
- Replaces H6014/H6024, high and low beam

30354



Universal

7" GLASS HEADLIGHT W/ 1893 Accent Socket

- 7" round glass headlight with 1893 accent socket
- High beam only

31393

LED HEADLIGHTS



Universal

5 3/4" LED HEADLIGHT W/ POSITION LIGHT

- 9 high power 5 3/4" LED headlight with LED position light bar
- High power bright LED high and low beam
- Reinforced aluminum reflector with rugged anti-vibration construction

31259 | Amber LED Position Light Bar

31267 | White LED Position Light Bar



Universal

5 3/4" LED HEADLIGHT

- 8 high power 5 3/4" LED headlight
- Replaces H5001 and H5006 bulb, DOT/SAE and FMVSS 108 compliant
- Easy connection, fits OEM housing or fender, plugs into existing wiring harness
- Low beam 1,020 lumens, high beam 1,600 lumens

31201 | Silver

31202 | Black



Universal

5 3/4" CRYSTAL HEADLIGHT

- Beautiful crystal clear front lens
- Reinforced multi-surfaced, aluminum reflector, rugged anti-vibration construction
- Sylvania halogen bulb: SAE 9007 12V 65/55W
- Replaces H5001/H5006, SAE & ECE approved
- 9007 bulb adapter plug included, item # 34207V

31386



Universal

5 3/4" SEALED BEAM HEADLIGHT

- 5 3/4" round sealed beam Philips headlight
- High beam and low beam

H5006

LED HEADLIGHTS



Universal

5"x7" LED HEADLIGHT

- 9 high power LED rectangular headlight with 6 white LED light bar
- Reinforced aluminum reflector, rugged anti-vibration construction
- IP67 weatherproof rating
- High beam 3,700 lumens, low beam 1,800 lumens

34122



Universal

5"x7" LED HEADLIGHT

- 12 High power LED rectangular headlight with durable corrosion resistant polycarbonate lens & housing
- Solid state design resists shock and vibration
- Easy connection, fits OEM housing, plugs into existing wiring harness, position light requires additional wiring
- High beam 1,100 lumens, low beam 600 lumens

31087



Universal

5"x7" LED CRYSTAL HEADLIGHT

- 5 high power LED crystal headlight with high and low beam function
- Reinforced aluminum reflector and rugged anti-vibration construction

31297

LED HEADLIGHTS



Universal

4"x6" LED HEADLIGHT W/ AMBER AUXILIARY

- High power LED headlight with quality crystal clear polycarbonate lens
- Center light bar with 9 super bright amber LEDs
- Waterproof die-cast housing provides maximum protection and durability
- OEM fit, plugs into existing wiring harness
- Sold individually, please specify low beam or high beam

31150 | Low Beam

31151 | High Beam



Universal

4"x6" LED HEADLIGHT W/ WHITE AUXILIARY

- High power LED headlight with quality crystal clear polycarbonate lens
- Center light bar with 9 super bright white LEDs
- Waterproof die-cast housing provides maximum protection and durability
- OEM fit, plugs into existing wiring harness
- Sold individually, please specify low beam or high beam

31152 | Low Beam

31153 | High Beam



Universal

4"x6" LED CRYSTAL HEADLIGHT

- High power 5 LED rectangular crystal headlight with high and low beam function
- Reinforced aluminum reflector, rugged anti-vibration construction
- Replaces H4651/H4656
- SAE approved

31365

LED HEADLIGHTS



Universal

4"x6" LED HEADLIGHT-HIGH BEAM

- Durable corrosion resistant polycarbonate lens & housing
- Solid state design resists shock and vibration
- Easy connection, fits OEM housing, plugs into existing wiring harness, position light requires additional wiring
- High beam 1000 lumens, 6500kelvin, 12-24v DC input

31089



Universal

4"x6" LED HEADLIGHT-LOW BEAM

- Durable corrosion resistant polycarbonate lens & housing
- Solid state design resists shock and vibration
- Easy connection, fits OEM housing, plugs into existing wiring harness, position light requires additional wiring
- Low beam 750 lumens, 6500kelvin, 12-24v DC input

31088



Universal

4"x6" BLACKOUT LED HEADLIGHT-HIGH BEAM

- 4"x6" rectangular crystal headlight with 1 high power LED and 6 high power LED position lights
- Solid state design resists shock and vibration
- Durable corrosion resistant polycarbonate lens & housing
- Load resistor may be required for proper installation
- DOT/SAE FMVSS 108

31299

LED HEADLIGHTS



Universal

4"x6" LED HEADLIGHT W/ POSITION LIGHT

- Rectangular 1 high power LED headlight with 6 amber LED dual function position lights
- Solid state design resists shock and vibration
- Die-cast aluminum housing, impact resistant polycarbonate lens for protection from road hazards
- 12-24v DC input, ~.35 Amps / 8.5 Watt, FMVSS 108
- Sold individually, please specify low beam or high beam

31237 | Low Beam

31238 | High Beam



Universal

4"x6" LED HEADLIGHT W/ POSITION LIGHT

- Rectangular 1 high power LED headlight with 6 white LED dual function position lights
- Solid state design resists shock and vibration, DOT/SAE headlight compliant
- Die-cast aluminum housing, impact resistant polycarbonate lens for protection from road hazards
- Low beam 600 lumens, high beam 1,000 lumens
- Sold individually, please specify low beam or high beam

31168 | Low Beam

31169 | High Beam



Universal

4"x6" CRYSTAL PROJECTION HEADLIGHT

- Crystal projection headlight with 6 white LED position lights
- Reinforced aluminum reflector, rugged anti-vibration construction
- Low beam includes two 9005 adapter plugs (one 3 wire to 2 wire plug and one 2 wire plug)
- High beam has 2 wires and 9005 adapter plug
- Sold individually, please specify low beam or high beam

31375 | Low Beam

31376 | High Beam

LED HEADLIGHTS



Universal

4"x6" LED PROJECTION HEADLIGHT

- 11 high power LED projection headlight with white LED position light bar
- Die-cast aluminum housing, impact resistant polycarbonate lens for protection from road hazards
- Solid state design resists shock and vibration, DOT/SAE FMVSS 108

31274 | Low Beam

31275 | High Beam



Universal

4"x6" LED HEADLIGHT W/ LED LIGHT BAR

- 9 high power LED dual function light with 6 white LED light bar
- Reinforced aluminum reflector, rugged anti-vibration construction
- Headlight fits OEM housing, plugs into existing wiring harness
- For off-road use only

34125



Universal

4"x6" CREE LED HEADLIGHT

- 1 high power Cree LED headlight
- Solid state design resists shock and vibration, DOT/SAE FMVSS 108
- Improves visibility with whiter light output that is closer to daylight
- Durable corrosion resistant polycarbonate lens & housing
- Load resistor may be required for proper installation, SAE/DOT FMVSS108
- Sold individually, please specify low beam or high beam

31396 | Low Beam

31397 | High Beam

HEADLIGHTS W/ LED POSITION



Universal

4"x6" LED CRYSTAL HEADLIGHT

- Crystal headlight with 9 amber LED position lights
- Reinforced aluminum reflector
- Rugged anti-vibration construction
- Sold individually, please specify low beam or high beam

31373 | Low Beam

31374 | High Beam



Universal

4"x6" CRYSTAL HL W/ LED POSITION LIGHT

- Crystal headlight with 9 white LED position lights
- Reinforced aluminum reflector
- Rugged anti-vibration construction
- Sold individually, please specify low beam or high beam

31368 | Low Beam

31369 | High Beam

HEADLIGHTS



Universal

4"x6" RECTANGULAR CRYSTAL HEADLIGHT

- Reinforced aluminum reflector, rugged anti-vibration construction
- Replaceable bulb, Sylvania halogen bulb: SEA-9007 12V 65/55W
- Replaces H4651/H4556, SAE & ECE approved
- High and low beam, 9007 bulb adapter plug included

31388



Universal

4"x6" RECTANGULAR CRYSTAL HEADLIGHT

- Reinforced aluminum reflector, rugged anti-vibration construction
- Replaceable bulb, Sylvania halogen bulb: SEA-9007 12V 65/55W
- Replaces H4651/H4556, SAE & ECE approved
- High beam only, 2 wire 9007 bulb adapter plug included

31390



Universal

5"x7" RECTANGULAR CRYSTAL HEADLIGHT

- Reinforced aluminum reflector, rugged anti-vibration construction
- Replaceable bulb, Sylvania halogen bulb: H4/HB2, 12V 65/55W
- Replaces H6054

31389

BULBS / ADAPTERS / ETC.



Universal

9005/HB3 LED HEADLAMP BULB

- 2 Cree high power white LED headlamp bulb
- 10W low beam application, bright 1,200 lumen output, 6,000k
- Fan-less design, proprietary heat sink dissipates excess heat
- Sold individually

36888



Universal

XENON WHITE 9007 HALOGEN BULB

- 12V, Hi/Low function
- High beam 100 watt/low beam 80 watt
- Sold in pairs

39132

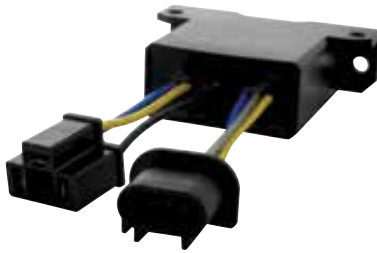

Universal

LED HL ANTI FLICKER MODULE & ADAPTER

- LED headlight PWM anti flicker module & adapter for most vehicles using pulse width modulated electrical systems
- Eliminates flicker on LED headlamps
- Adapts common H13 plug to H4 plug used by most LED headlights

34217B

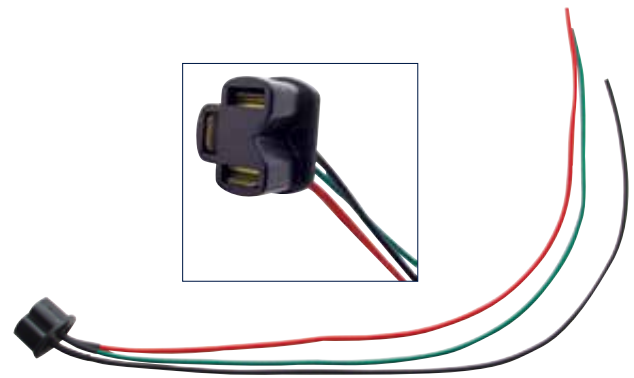

Universal

HEADLIGHT PIGTAIL

- 3 contact female pigtail for H4 halogen bulbs
- Head resistant wire, OEM #: 01A-13076
- Sealed beam or halogen bulb socket with 3 high heat resistant nylon wires, black, green and red

34222

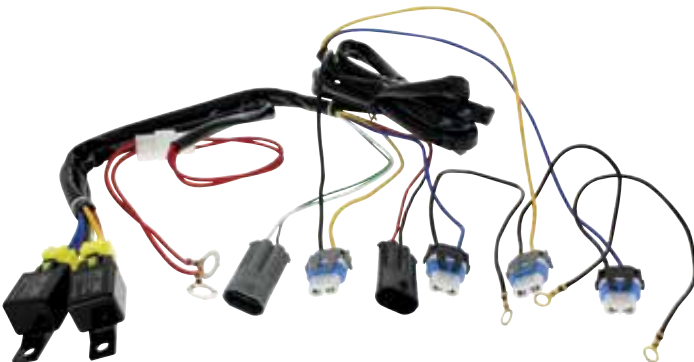

Universal

9005/9006 HEADLIGHT RELAY HARNESS KIT

- Sends high amperage to headlamps and corrects dim lights
- 12 volt

34264

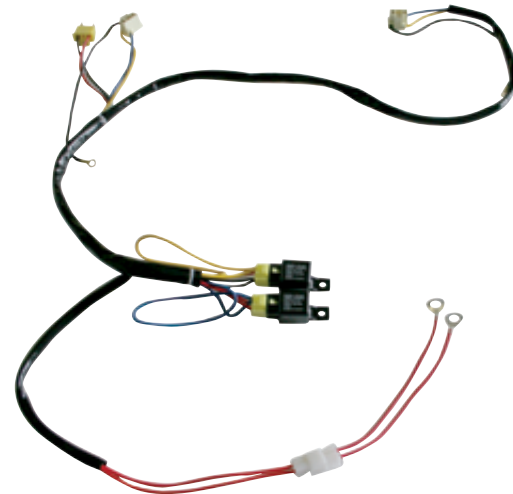

Universal

H4 HEADLIGHT RELAY HARNESS KIT

- Sends high amperage to headlamps and corrects dim lights
- Works on original style 6014 sealed beams

34263

LED CONTROL MODULE

Universal

DUAL FUNCTION LED CONTROL MODULE

- Add dual function high/low brightness to 31378 and 31379 headlamps with 34 LED accent lights
- Built in split operation for motorcycle application
- Easy plug & play hookup, wiring instructions included
- Sold individually, for 12 Volt LED use only

31372

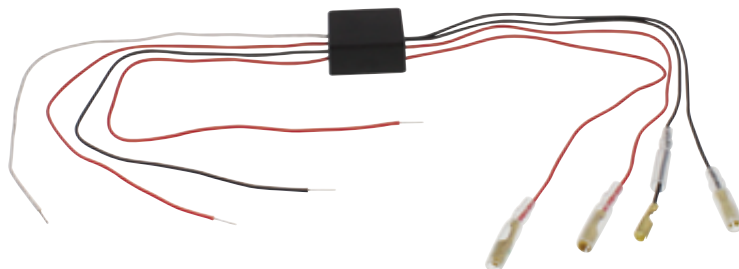

For Cars & Trucks

- Red wires 12+ for turn signal (high brightness). Connect BOTH red wires together.
- Black wire 12+ for parking/running light (lower brightness).
- White wire negative (ground-).

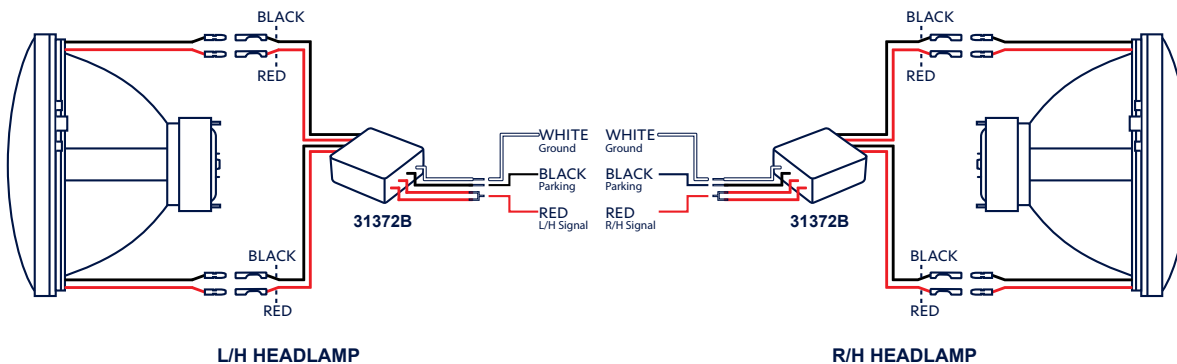

For Motorcycles

- Red wires 12+ for R/H and L/H turn signal (high brightness).
- Black wire 12+ for parking/running light (lower brightness).
- White wire negative (ground-).

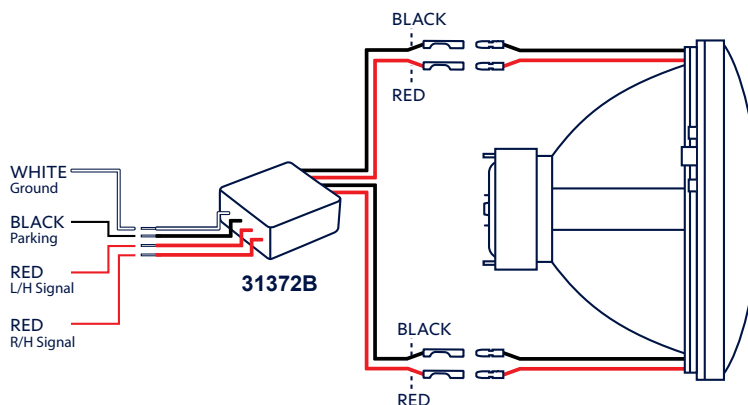

HEADLIGHT PARTS



1947-54 Chevy Truck

HEADLIGHT RIM KIT

- Includes 2 polished stainless steel headlight bezels, 2 rubber "o" ring gaskets, 2 set clips
- Headlight bezels, "o" rings, and clip set also available separately

C7011-KIT

C7011 | Headlight Bezel Only

C7012 | Bezel "O" Ring Only

C7013 | Headlight Clip Set Only



1963 Chevrolet Truck

CHROME HEADLIGHT BEZEL

- Beautiful triple chrome plating
- 8 oval head sheet metal screws included
- Sold in pairs

110429



1955-57 Chevy Truck

CHROME HEADLAMP BEZEL SET

- Beautiful chrome plating
- High quality rubber seals included
- Sold as a set

110705



1958-59 Chevy Truck

CHROME HEADLIGHT BEZEL

- Sold in pairs

C585981

HEADLIGHT PARTS

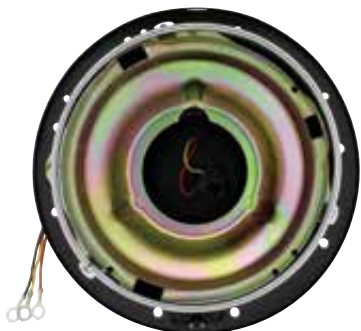

1947-54 Chevy & GMC Truck

HEADLIGHT BUCKET

- Steel reproduction like original
- Includes inner headlamp cradle, aiming adjusters, springs, chrome headlamp retainer ring and screws
- Headlamp wiring pigtail with ring terminals like original
- Fits LH/Driver and RH/Passenger

110282



1955-57 Chevy & GMC Truck

HEADLIGHT BUCKET

- Steel reproduction like original
- Includes headlamp bulb retaining ring and electrical pigtail
- Fits LH/Driver and RH/Passenger

110283



1967-72 GMC Truck

HEADLIGHT MOUNTING BUCKET SET

- High quality 19 gauge sheet metal stamped buckets, 8 piece set
- Each bucket is properly trimmed with grooves for specific bulbs
- Chrome plated headlight retainer rings
- 6-32 screws included for mounting retainer ring to bucket

110358

HEADLIGHT VISORS



Universal

7" ROUND HEADLIGHT DROP VISOR

• Sold individually

10532 | Stainless Steel



Universal

7" ROUND HEADLIGHT VISOR

• Sold individually

10468 | Stainless Steel

10467 | Chrome



HEADLIGHT VISORS



Universal

CHROME HALF MOON HEADLIGHT SHIELDS

- Stick out style headlight visor
- Fits 5 3/4" headlights or dual round headlight systems
- Sold in pairs

- 10476 | 7 1/2" | Chrome | Fits 6014, 6015, 6016
 10477 | 5 3/4" | Chrome | Fits 4000, 4001, 4040, 5001
 21476 | 7 1/2" | Stainless Steel | Fits 6014, 6015, 6016
 21477 | 5 3/4" | Stainless Steel | Fits 4000, 4001, 4040, 5001



Universal

HEADLIGHT VISORS WITH GLASS DOTS

- 7 1/2" round headlight visor
- Sold individually

- 10444 | Blue Dot | Chrome
 10445 | Blue Dot | Stainless Steel
 10448 | Red Dot | Chrome
 10449 | Red Dot | Stainless Steel



Universal

OUTSIDE MOUNTING HEADLIGHT VISORS

- Stainless steel
- Fits 7 1/2" headlights
- Sold in pairs

C5010



Universal

OUTSIDE MOUNTING HEADLIGHT VISORS

- Stainless steel
- Fits 7 1/2" headlights
- Sold in pairs

C5006



Universal

TRANSPARENT PLASTIC VISORS

- 7 1/2" headlight visor
- Sold in pairs

- C2001A | Amber
 C2001B | Blue
 C2001G | Green
 C2001R | Red



Universal

CHROME CATS EYE HEADLIGHT COVERS

- Also fits Volkswagen 67-68 Beetle, 67-73 Type LII, 68/69 Bus, 74-77 Dasher, and 75-79 Rabbit
- Sold in pairs

- 10466 | 7" Headlights
 10461 | 5 3/4" Headlights

LED TAIL LIGHTS



LED TAIL LIGHTS



1940-53 Chevy Truck

23 LED TAIL LIGHT ASSEMBLY W/ BLUE DOT

- 23 super bright red LEDs, with LED blue dot, 6 super white LEDs for license light, polycarbonate lens
- Blue dot can be controlled independently with additional wiring
- Sold individually please specify LH/Driver or RH/Passenger

C7031RLBD | Black Housing | LH/Driver

C7031RRBD | Black Housing | RH/Passenger

C7033RLBD | Stainless Housing | LH/Driver

C7033RRBD | Stainless Housing | RH/Passenger

1940-53 Chevy & GMC Truck

27 LED SEQUENTIAL TAIL LIGHT ASSEMBLY

- 27 super bright red LEDs, 6 super white LEDs for license light
- Features sequential operation with selector switch to select sequential left, sequential right, or sequential function off
- Features sequential once brake attention function
- LH/Driver side includes 6 super bright white LED license light
- Recommended to upgrade with LED flasher 90652
- Sold individually please specify LH/Driver or RH/Passenger

110415 | Black Housing | LH/Driver

110416 | Black Housing | RH/Passenger

110419 | Stainless Housing | LH/Driver

110420 | Stainless Housing | RH/Passenger



LED TAIL LIGHTS



C7031RL



C7033RL



C7001L



C7028L-1

1940-53 Chevy & GMC Truck

45 LED TAIL LIGHT ASSEMBLY

- 45 super bright LED tail light, 6 super bright white LED license light
- Recommended to upgrade with LED flasher 90652 (2-Terminal) Or 90651 (3-Terminal)
- Sold individually please specify LH/Driver or RH/Passenger

C7031RL | Black Housing | LH/Driver
 C7031RR | Black Housing | RH/Passenger
 C7033RL | Stainless Housing | LH/Driver
 C7033RR | Stainless Housing | RH/Passenger

1940-53 Chevy & GMC Truck

TAIL LIGHT ASSEMBLY W/ RED GLASS LENS

- High quality chrome plated bezel with black or chrome housing
- Sold individually please specify LH/Driver or RH/Passenger

C7001L | Black Housing | LH/Driver
 C7001R | Black Housing | RH/Passenger
 C7001L-1 | Black / Blue Dot | LH/Driver
 C7001R-1 | Black / Blue Dot | RH/Passenger
 C7002R | Stainless Housing | RH/Passenger
 C7028L | Stainless Housing | LH/Driver
 C7028R | Stainless Housing | RH/Passenger
 C7028L-1 | Stainless / Blue Dot | LH/Driver
 C7028R-1 | Stainless / Blue Dot | RH/Passenger



1940-53 Chevy & GMC Truck

27 LED SEQUENTIAL TAIL LIGHT LENS

- 27 super bright red LEDs, 6 super white LEDs for license light
- Features sequential operation with selector switch to select sequential left, sequential right, or sequential function off
- Features sequential once brake attention function
- LH/Driver includes LED license illuminator lens with 6 super bright white LEDs
- Recommended to upgrade with LED flasher 90652
- Sold individually please specify LH/Driver or RH/Passenger

110110 | LH/Driver
 110111 | RH/Passenger

(((SEQUENTIAL)))
 F • L • A • S • H

(((BRAKE)))
 ATTENTION



Recommended Item:
 LED Flasher - Item # 90652

LED TAIL LIGHTS



1940-53 Chevy & GMC Truck/ 1937-38 Chevy Car

23 LED TAIL LIGHT W/ BLUE DOT

- 23 LED tail light w/ LED blue dot, with polycarbonate lens
- Dual function with tail light and bright stop/turn signal
- Left hand includes 6 super white LED license plate lights
- Epoxy coated, fully sealed electronics
- Energy efficient solid-state circuit board engineered for 7.7-14.0 VDC systems
- Recommended to upgrade with LED flasher 90652

CTL4053LED-LBD | LH/Driver

CTL4053LED-RBD | RH/Passenger



1940-53 Chevy & GMC Truck/ 1937-38 Chevy Car

23 LED TAIL LIGHT W/ BLUE DOT SET

- 23 LED tail light w/ LED blue dot, with polycarbonate lens
- Dual function with tail light and bright stop/turn signal
- Left hand includes 6 super white LED license plate light
- Epoxy coated, fully sealed electronics
- Energy efficient solid-state circuit board engineered for 7.7-14.0 VDC systems
- Recommended to upgrade with LED flasher 90652

• Set includes: CTL4053LED-LBD & CTL4053LED-RBD

110750



1940-53 Truck / 1937-38 Chevy Passenger Car

27 LED TAIL LIGHT LENS

- 27 super bright red LEDs for tail light and 6 white LEDs for license plate light
- Epoxy coated, fully sealed electronics
- Solid state circuit boards are designed for 7.7-14.0 VDC

CTL4053LED-L | LH/Driver

CTL4053LED-R | RH/Passenger



1940-53 Chevy & GMC Truck

RED GLASS TAIL LIGHT LENS

- Beautiful red glass lens
- Identical shape and size as the original
- Sold individually

C4009 | Red Lens

C4009-1 | Red Lens w/ Blue Dot

LED TAIL LIGHTS



1954-59 Chevy & GMC Truck

LED SEQUENTIAL TAIL LIGHT ASSEMBLY

- Super bright red LED light with housing
- Features sequential operation with selector switch to select sequential left, sequential right, or sequential function off
- Features sequential once brake attention function
- Requires use of United Pacific LED turn signal flasher, item number: 90652 or 90649
- DOT & SAE approved

110767 | Black Housing

110768 | Chrome Housing



1954-59 Chevy & GMC Truck

29 LED TAIL LIGHT ASSEMBLY

- 29 super bright red LED light with housing
- Epoxy coated, fully sealed electronics
- 1157 double connector with off set pins, plugs into existing tail lamp socket
- Requires use of United Pacific LED turn signal flasher, item number: 90652 or 90649
- DOT & SAE approved

110765 | Black Housing

110766 | Chrome Housing



1954-59 Chevy Truck

41 LED TAIL LIGHT ASSEMBLY

- 41 super bright red LED light with polycarbonate lens
- Epoxy coated, fully sealed electronics, 1157 plug
- Recommended upgrade with LED flasher No. 90652 (2-terminal) or 90651 (3-terminal)

CTL5459BR | Black Housing

| Red Lens

CTL5459BC | Black Housing

| Clear Lens

CTL5459SR | Stainless Steel Housing

| Red Lens

CTL5459SC | Stainless Steel Housing

| Clear Lens

TAIL LIGHTS



1960-66 Chevy Stepside Truck

41 LED TAIL LIGHT ASSEMBLY

- 41 super bright red LED light with polycarbonate lens
- Epoxy coated, fully sealed electronics

CTL6066BR | Black Housing | Red Lens
 CTL6066BC | Black Housing | Clear Lens
 CTL6066SR | Stainless Steel Housing | Red Lens
 CTL6066SC | Stainless Steel Housing | Clear Lens

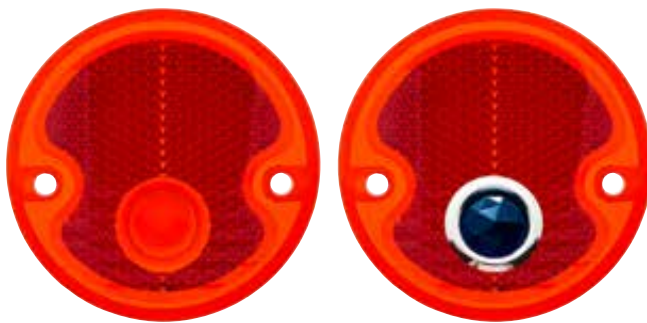

1954-55 Chevy 1st Series Truck

TAIL LIGHT ASSEMBLY

- Injection molded high quality polycarbonate plastic with chrome plated bezel
- Sold individually

C545505 | W/O Blue Dot
 C545507 | W/ Blue Dot



1954-55 Chevy Truck

TAIL LIGHT ASSEMBLY

- Injection molded high quality polycarbonate plastic with chrome plated bezel
- Sold individually

C545504BK | Black Housing
 C545504SS | Stainless Housing



1955-59 Chevy Truck

TAIL LIGHT ASSEMBLY

- Injection molded high quality polycarbonate plastic
- Sold individually

C555910 | Black Housing
 C555911 | Stainless Housing



1960-66 Chevy Stepside Truck

TAIL LIGHT ASSEMBLY

- Injection molded high quality polycarbonate plastic
- Sold individually

C606607 | Black Housing
 C606608 | Stainless Steel Housing

LED TAIL LIGHTS



1955-59 Chevy Stepside Truck

TAIL LIGHT LENS

- Injection molded from high quality polycarbonate plastic
- Sold individually

C555908 | Red Lens

C555912 | Red lens w/ Blue Dot



1958-59 Chevy Fleetside Truck

TAIL LIGHT LENS

- Injection molded from high quality polycarbonate plastic
- Sold individually

C585901 | Red Lens

C585902 | Red Lens w/ Blue Dot



1960-66 Chevy Stepside Truck

TAIL LIGHT LENS

- Injection molded from high quality polycarbonate plastic
- Sold individually

C606605 | Red Lens

C606610 | Red Lens w/ Blue Dot



1954-59 Chevy Truck

41 LED TAIL LIGHT

- 41 super bright red LEDs
- Epoxy coated, fully sealed electronics
- Solid state circuit boards are designed for 7.7-14.0 VDC

CTL5459LED | Red Lens

CTL5459C | Clear Lens



1958-59 Chevy Truck

41 LED TAIL LIGHT

- 41 super bright red LEDs
- Epoxy coated, fully sealed electronics
- Solid state circuit boards are designed for 7.7-14.0 VDC

CTL5859LED | Red Lens

CTL5859C | Clear Lens



1960-66 Chevy Truck

41 LED TAIL LIGHT

- 41 super bright red LEDs
- Epoxy coated, fully sealed electronics
- Solid state circuit boards are designed for 7.7-14.0 VDC

CTL6066LED | Red Lens

CTL6066C | Clear Lens

LED TAIL LIGHTS

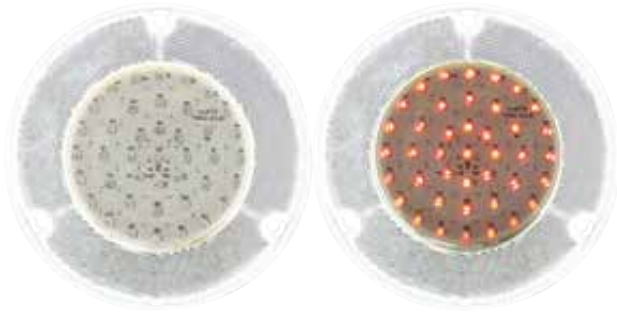

1967-72 Chevy Stepside Truck

41 LED TAIL LIGHT

- 41 Super bright red LEDs with clear lens
- Polycarbonate lens, epoxy coated, fully sealed electronics
- 1157 plug
- Energy efficient solid state circuit board engineered for 7.7-14.0 VDC systems
- Recommended under dash flasher is item no. 90652 (2-Terminal) or 90651 (3-terminal)
- Sold individually

CTL6722CL

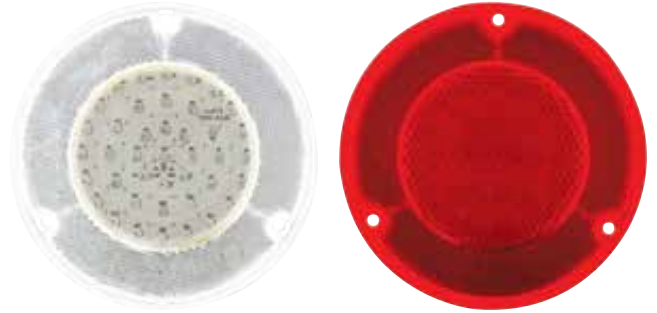

1967-72 Chevy Truck

41 LED TAIL LIGHT

- 41 super bright red LEDs
- Epoxy coated, fully sealed electronics
- Solid state circuit boards are designed for 7.7-14.0 VDC

CTL6772LED | Red Lens

CTL6772C | Clear Lens

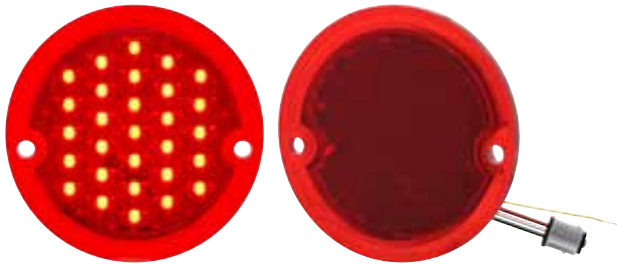

1954-59 Chevy & GMC 2nd Series Stepside Truck

29 LED TAIL LIGHT

- 29 LED red tail light
- Sold individually

110404



1954-59 Chevy & GMC 2nd Series Stepside Truck

29 LED SEQUENTIAL TAIL LIGHT

- 29 LED sequential tail light
- Sold individually

110405



1955-58 Chevy Cameo Truck

TAIL LIGHT LENS

- Injection molded from high quality polycarbonate plastic
- Sold individually

C7006 | Red Lens

C7006-1 | Red Lens w/ Blue Dot



1956-59 Chevy & GMC Panel Truck

TAIL LIGHT LENS

- Injection molded from high quality polycarbonate plastic
- Sold individually

C7008 | Red Lens

C7008-1 | Red Lens w/ Blue Dot

LED TAIL LIGHTS

1960-66 Chevy & GMC Fleetside Truck

TAIL LIGHT ASSEMBLY

- Includes housing, lens, gasket, socket, 1157 bulb & wiring
- Sold individually

C606616 | Original Lens

C606616BD | Red Lens w/ Blue Dot

C606616C | Clear Lens w/ Red Bulb



1960-66 Chevy Fleetside Truck

LED TAIL LIGHT ASSEMBLY

- Complete with housing, lens gasket, socket & wiring
- Sold individually please specify LH/Driver or RH/Passenger

CTL6066FSR | Red Lens

CTL6066FSC | Clear Lens/Red LED



1960-66 Chevy & GMC Fleetside Truck

40 LED SEQUENTIAL TAIL LIGHT

- 40 super bright red LED with fully sealed epoxy coated electronics
- Features sequential operation with selector switch to select sequential left, sequential right, or sequential function off
- Features sequential once brake attention function
- Complete with zinc plated housing, lens, gasket, socket & wiring
- OE style wiring with bullet terminal connectors
- Requires use of United Pacific LED turn signal flasher, item number: 90652 or 90649
- SAE/DOT FMVSS108

110795

LED TAIL LIGHTS



1960-66 Chevy & GMC Fleetside Truck

40 LED SEQUENTIAL TAIL LIGHT

- 40 super bright red LED with fully sealed epoxy coated electronics
- Available with standard LED or sequential operation with selector switch to select sequential left, sequential right, or sequential function off
- Complete with polycarbonate lens and LEDs sealed inside
- Easy electrical connection with 1157 plug, 12 volt only
- Recommended Under Dash Flasher Is Item No. 90652 (2-Terminal) Or 90651 (3-Terminal)

110199



1960-66 Chevy Truck

40 LED TAIL LIGHT

- 40 super bright red LEDs, epoxy coated, fully sealed electronics
- Solid state circuit boards are designed for 7.7-14.0 VDC

CTL6066FSLED | Red Lens

CTL6066FC | Clear Lens



1960-66 Chevy & GMC Fleetside Truck

TAIL LIGHT LENS

- Injection molded from high quality polycarbonate plastic
- Sold individually

C606617 | Red Lens

C606618 | Red Lens w/ Blue Dot

1960-66 Chevy & GMC Fleetside Truck

TAIL LIGHT LENSES AND BULBS

- Injection molded from high quality polycarbonate plastic
- Fits LH/Driver and RH/Passenger
- Use 39014 clear with red lenses, 39006 red bulb with clear lenses

C606609 | Red Lens

C606611 | Red Lens w/ Blue Dot

C60609C | Clear Lens

39014 | Clear 1157 Bulb 2 Pack

39006 | Red 1157 Bulb 10 Pack

C606603 | Aluminum Bezel

LED TAIL LIGHT ASSEMBLIES

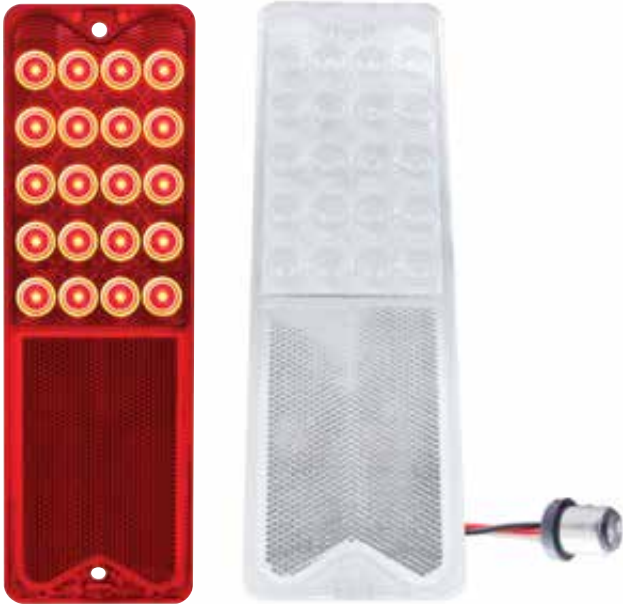

1967-72 Chevy Fleetside Truck

20 LED TAIL LIGHT

- 20 Super bright red LEDs
- Polycarbonate lens, epoxy coated, fully sealed electronics, 1157 plug
- Energy efficient solid state circuit board engineered for 7.7-14.0 VDC systems
- Recommended under dash flasher is item no. 90652 (2-Terminal) or 90651 (3-terminal)
- Sold individually

CTL6721LED | Red Lens
CTL6721C | Clear Lens

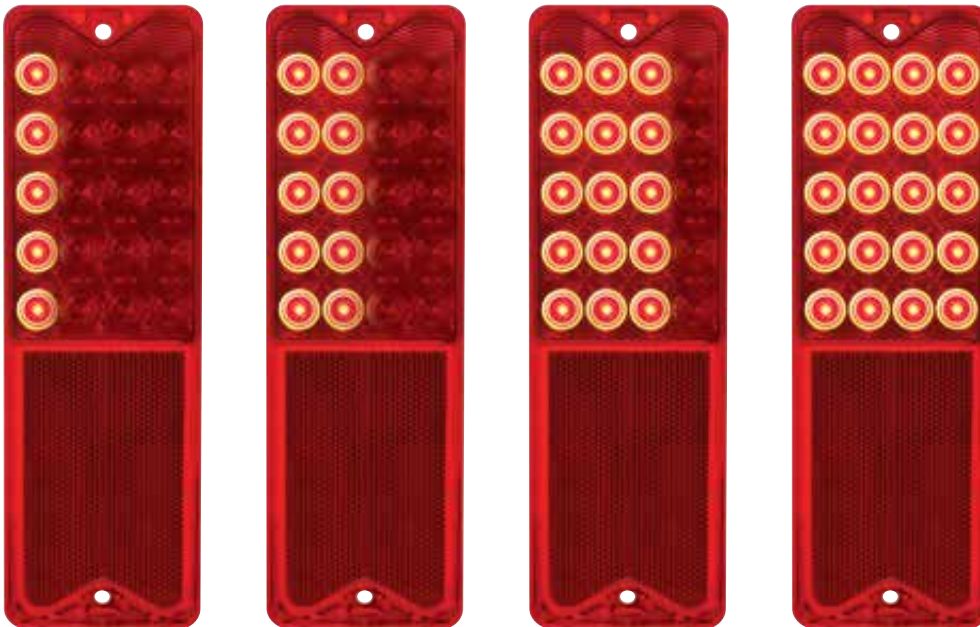

SEQUENTIAL
F · L · A · S · H

(((BRAKE ATTENTION)))



1967-72 Chevy & GMC Fleetside Truck

20 LED SEQUENTIAL TAIL LIGHT ASSEMBLY

- 20 Super bright red LEDs, complete with polycarbonate lens
- Available with standard LED or sequential operation with selector switch to select sequential left, sequential right, or sequential function off
- Features sequential-once brake attention function
- Complete with polycarbonate lens and LEDs sealed inside
- Easy electrical connection with 1157 plug, 12 volt only
- Recommended Under Dash Flasher Is Item No. 90652 (2-Terminal) Or 90651 (3-Terminal)
- Lifetime warranty

CTL6721SEQ

LED SEQUENTIAL TAIL LIGHTS



1967-72 Chevy & GMC Fleetside Truck

20 LED SEQUENTIAL TAIL LIGHT ASSEMBLY

- 20 Super bright red LEDs, complete with polycarbonate lens
- Includes steel tail light housing with socket and gasket
- Available with standard LED or sequential operation with selector switch to select sequential left, sequential right, or sequential function off
- Features sequential-once brake attention function
- Epoxy coated, fully sealed electronics, 1157 plug
- Solid state circuit boards are designed for 7.7-14.0 VDC
- Recommended under dash flasher is item no. 90652 (2-Terminal) or 90651 (3-terminal)

110213

110214



《《 SEQUENTIAL 》》
F · L · A · S · H

(((BRAKE)))
ATTENTION



1967-72 Chevy & GMC Fleetside Truck

TAIL LIGHT LENS

- Sold individually

C677209

TAIL LIGHTS



1973-87 Chevy & GMC Truck

20 LED SEQUENTIAL TAIL LIGHT

- 20 Super bright red LEDs, with polycarbonate lens
- Mounting base plate included
- Features sequential operation with selector switch to select sequential left, sequential right, or sequential function off
- Features sequential-once brake attention function
- Epoxy coated, fully sealed electronics, 1157 plug
- Solid state circuit boards are designed for 7.7-14.0 VDC
- Recommended under dash flasher is item no. 90652 (2-Terminal) or 90651 (3-terminal)

CTL7387LED-L | LH/Driver

CTL7387LED-R | RH/Passenger



1973-87 Chevy & GMC Truck

TAIL LIGHT ASSEMBLY WITH TRIM

- Injection molded from high quality polycarbonate plastic
- Beautiful anodized aluminum trim
- Sold individually

C738705 | LH/Driver

C738704 | RH/Passenger

1988-02 Chevy & GMC Truck

TAIL LIGHT

- Injection molded from high quality polycarbonate plastic
- Fits 1988-98 Chevy C/K truck & 99-02 Chevy Silverado Classic
- 1992-99 Chevy Suburban / GMC Suburban
- 1995-99 Chevy Tahoe / GMC Yukon / GMC Denali (full-size)
- 1992-94 Chevy Blazer (full-size) & GMC Jimmy (full-size)
- Sold individually

110114 | LH/Driver

110115 | RH/Passenger



TAIL LIGHT BEZELS



1940-53 Chevy Truck

TAIL LIGHT BEZEL

• Sold individually

C4008-1 | Chrome

C4008-2 | Stainless Steel



1954-55 Chevy 1st Series Truck

STAINLESS STEEL TAIL LIGHT BEZEL

• Sold individually

C545506



1955-59 Chevy Truck

STAINLESS STEEL TAIL LIGHT BEZEL / GASKET

• Sold individually

C555909 | Bezel

C555911-3 | Gasket



1958-59 Chevy & GMC Fleetside Truck

TAIL LIGHT BEZEL

• Sold individually

C585902ALU | Aluminum

C585902SS | Stainless Steel



1960-66 Chevy & GMC Fleetside Truck

ANODIZED ALUMINUM TAIL LIGHT BEZEL

• Sold individually

C606603



1954-59 Chevy Truck

TAIL LIGHT RUBBER CONDUIT

• Universal tail light wiring boot for all restoration projects

• Total length: 21 1/2"

• Sold individually

C545504-2

T/L HOUSINGS / BRACKETS



1960-66 Chevy & GMC Fleetside Truck

TAIL LIGHT HOUSING, GASKET & PIGTAIL

- Zinc plated housing with socket
- Socket wiring pigtail sold separately: C606615
- Sold individually

C606614 | Tail Light Housing

C606651 | Lens Gasket

C606615 | Pigtail



1967-72 Chevy & GMC Fleetside Truck

TAIL LIGHT HOUSING

- Zinc plated housing with socket
- Socket wiring pigtail sold separately: C606615
- Sold individually

C677207 | Tail Light Housing

110215 | Lens Gasket Pair

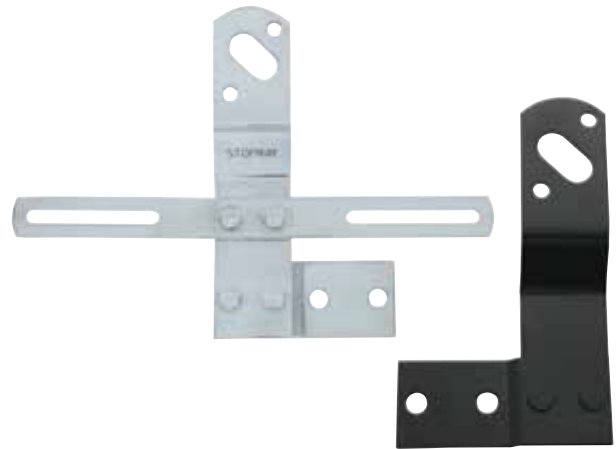

1947-53 Chevy & GMC 1st Truck

TAIL LIGHT BRACKET

- Sold individually

C7026RSS | Stainless Steel | RH/Passenger

C7026LSS | Stainless Steel | LH/Driver

C7003R | Black | RH/Passenger

C7003L | Black | LH/Driver

C7004R | Chrome | RH/Passenger

C7004L | Chrome | LH/Driver



1954-55 Chevy & GMC 1st Truck

TAIL LIGHT BRACKET

- Sold individually

C545502BK | Black | RH/Passenger

C545503BK | Black | LH/Driver

C545502CR | Chrome | RH/Passenger

C545503CR | Chrome | LH/Driver

C545502SS | Stainless Steel | RH/Passenger

C545503SS | Stainless Steel | LH/Driver



1955-66 Chevy & GMC 1st Truck

TAIL LIGHT BRACKET

- Sold individually

C556601BK | Black | RH/Passenger

C556602BK | Black | LH/Driver

C556601CR | Chrome | RH/Passenger

C556602CR | Chrome | LH/Driver

C556601SS | Stainless Steel | RH/Passenger

C556602SS | Stainless Steel | LH/Driver

TL GASKET / BACKUP LIGHTS

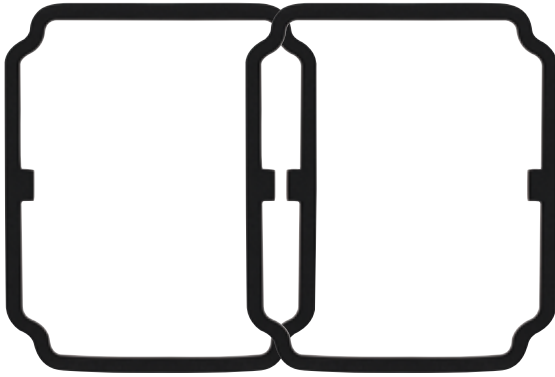

1973-87 Chevy & GMC Truck

TAIL LIGHT LENS GASKET

- Black EVA foam
- Precision die cut to OE specifications for a perfect fit
- Sold in pairs

C738703



1967-72 Chevy & GMC Truck

30 LED BACKUP LIGHT

- 30 white super bright LEDs, with desirable bullseye lens
- Epoxy coated, fully sealed electronics, 1156 plug
- Solid state circuit boards are designed for 7.7-14.0 VDC

110200 | LH/Driver

110201 | RH/Passenger



1967-72 Chevy & GMC Truck

BULLSEYE STYLE BACKUP LIGHT LENS

- Rare 1967-68 bullseye style circular pattern
- Sold individually

110362



1955-58 Chevy Cameo Truck

BACKUP LIGHT LENS

- Injection molded high quality polycarbonate plastic
- Sold in pairs

C7007



1967-72 Chevy & GMC Truck

BACKUP LIGHT LENS

- Injection molded high quality polycarbonate plastic
- Sold in pairs

110216

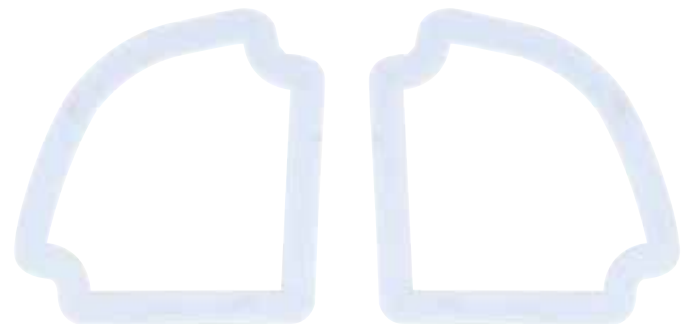

1967-72 Chevy & GMC Truck

BACKUP LIGHT GASKET

- White foam rubber like the original
- Fits between tail light housing and lens
- Sold in pairs

110202

LED PARKING LIGHTS



LED PARKING LIGHTS

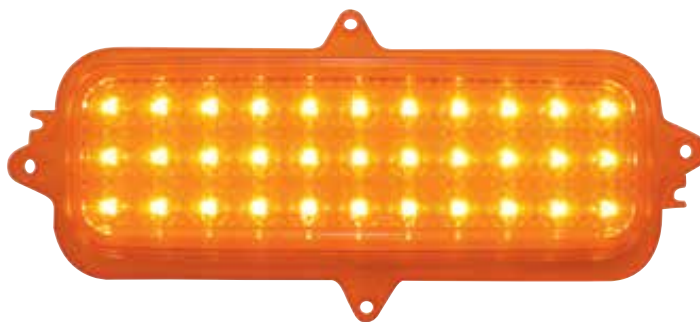

1960-66 Chevy & GMC Truck

LED PARKING LIGHT

- 33 amber super bright LEDs, polycarbonate lens
- Dual function with parking light and turn signal
- Epoxy coated, fully sealed electronics, 1157 plug

CPL6066A

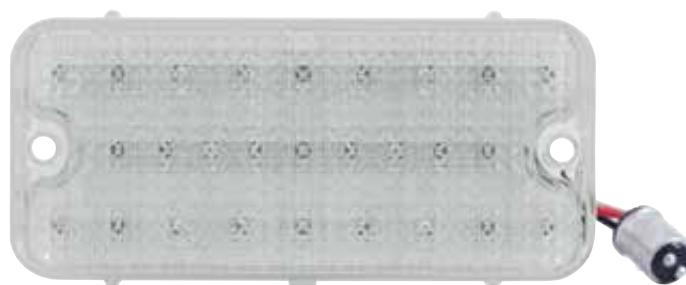
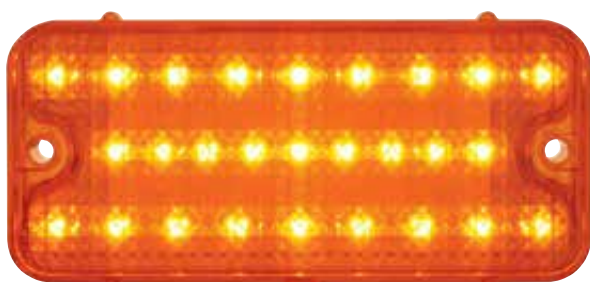

1967-68 Chevy & GMC Truck

LED PARKING LIGHT

- 27 amber super bright LEDs, polycarbonate lens
- Dual function with parking light and turn signal
- Epoxy coated, fully sealed electronics, 1157 plug

CPL6768A | Amber

CPL6768C | Clear

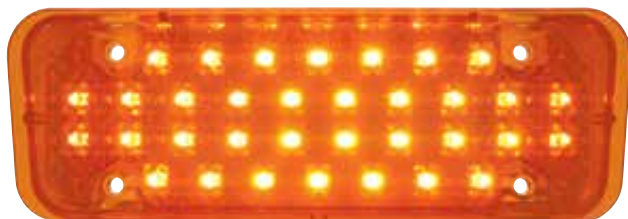

1971-72 Chevy & GMC Truck

LED PARKING LIGHT

- 34 super bright amber LEDs, polycarbonate lens
- Dual function, epoxy coated, fully sealed electronics, 1157 plug
- Fits LH/Driver and RH/Passenger

CPL7172A | Amber

CPL7172C | Clear



LED PARKING LIGHTS

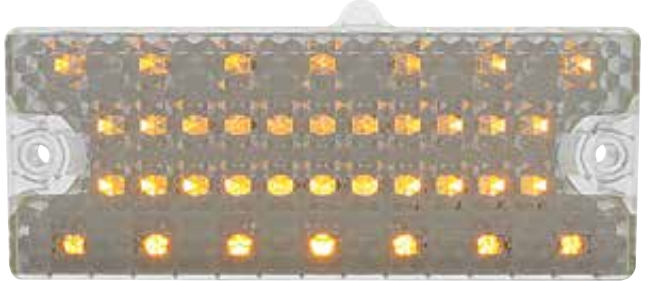
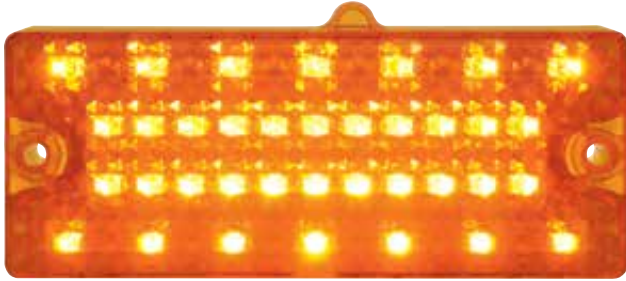

1969-70 Chevy & GMC Truck

LED PARKING LIGHT

- 36 amber super bright LEDs, with amber polycarbonate lens
- Dual function with parking light and turn signal
- Epoxy coated, fully sealed electronics, 1157 plug

CPL6970AL | LH/Driver

CPL6970AR | RH/Passenger

1969-70 Chevy & GMC Truck

LED PARKING LIGHT

- 36 amber super bright LEDs, with clear polycarbonate lens
- Dual function with parking light and turn signal
- Epoxy coated, fully sealed electronics, 1157 plug

CPL6970CL | LH/Driver

CPL6970CR | RH/Passenger



LED PARKING LIGHTS



1947-53 Chevy & GMC Truck

LED PARKING LIGHT ASSEMBLY

- Complete parking light assembly with LED lens installed
- Polished stainless steel bezel, black housing with socket and wires
- 24 amber super bright LEDs, polycarbonate lens
- Dual function with parking light and turn signal
- Epoxy coated, fully sealed electronics, 1157 plug

CPL4753A-AS | Amber

CPL4753C-AS | Clear

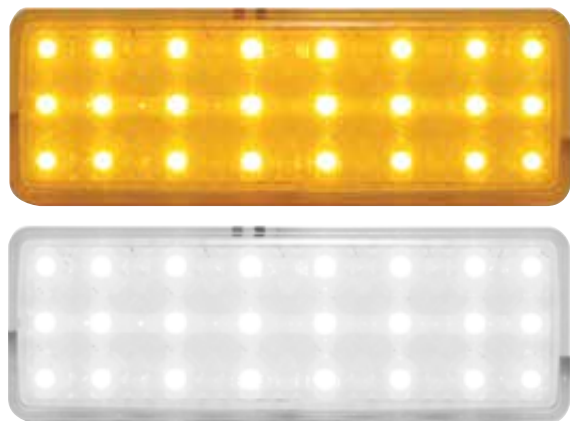

1947-53 Chevy & GMC Truck

LED PARKING LIGHT LENS

- 24 super bright LED parking light lens
- High quality injection molded polycarbonate lens
- Dual function with parking light and turn signal
- Epoxy coated, fully sealed electronics, 1157 plug

CPL4753A | Amber

CPL4753C | Clear



1951-53 GMC Truck

LED PARKING LIGHT

- Amber LEDs with clear lens

CPL5153C



1955-57 Chevy & GMC Truck

LED PARKING LIGHT

- 39 super bright LED parking light
- Polycarbonate lens with LEDs sealed inside
- Dual function with parking light and turn signal
- Easy electrical connection with 1157 plug, 12 volt only

CPL5557A | Amber

CPL5557C | Clear

PARKING LIGHT LENS



1942-46 Chevy Truck

GLASS PARKING LIGHT LENS

- Excellent quality all glass lens
- Sold individually

C7010



1947-53 Chevy Truck

CLEAR GLASS PARKING LIGHT LENS

- Fits LH/Driver or RH/Passenger
- Sold individually

C7019



1951-53 GMC Truck

PARKING LIGHT LENS

- Injection molded from high quality polycarbonate plastic
- Sold individually

C515301 | Clear



1955-57 Chevy Truck

PARKING LIGHT LENS

- Great looking replacement with new lens pattern
- Injection molded from high quality polycarbonate plastic

C555751A | Amber

C555751C | Clear



1955-57 Chevy Truck

PARKING LIGHT LENS

- Injection molded from high quality polycarbonate plastic
- Sold individually

C7014A | Amber

C7014C | Clear



1958-59 Chevy Truck

PARKING LIGHT LENS

- Fits LH/Driver or RH/Passenger
- Injection molded from high quality polycarbonate plastic
- Sold individually

C7009A | Amber

C7009C | Clear

PARKING LIGHT LENS

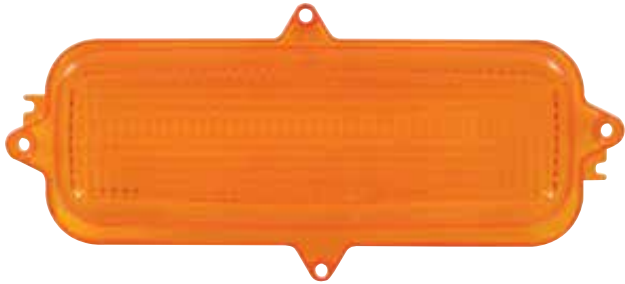

1960-66 Chevy Truck

PARKING LIGHT LENS

- Injection molded from high quality polycarbonate plastic
- Sold individually

C606621 | Amber

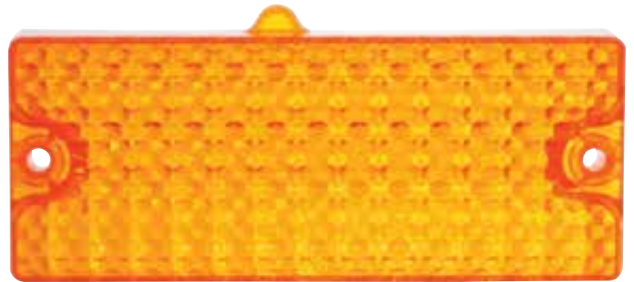
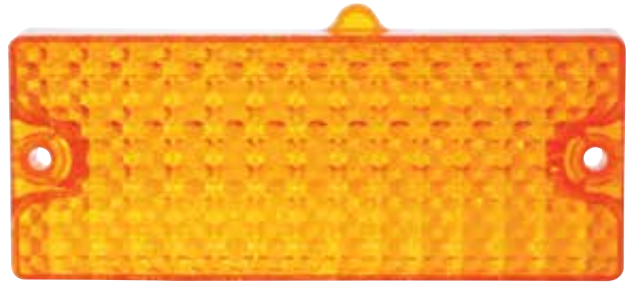

1969-70 Chevy Truck

PARKING LIGHT LENS

- Injection molded from high quality polycarbonate plastic
- Sold individually

C697020 | Amber LH/Driver

C697021 | Amber RH/Passenger

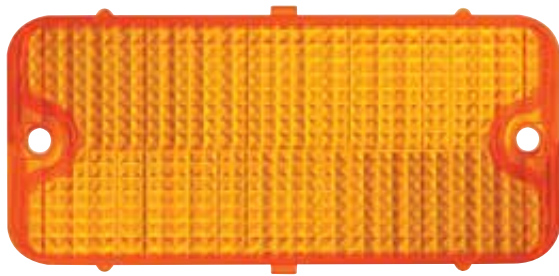

1967-68 Chevy Truck

PARKING LIGHT LENS

- Injection molded from high quality polycarbonate plastic
- Sold individually

C676811A | Amber

C676811C | Clear

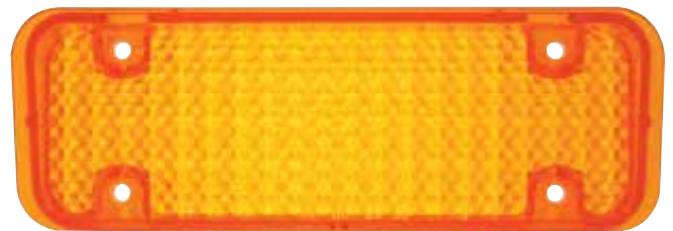

1971-72 Chevy Truck

PARKING LIGHT LENS

- Injection molded from high quality polycarbonate plastic
- Fits LH/Driver and RH/Passenger
- Sold individually

C717221 | Amber

PARKING LIGHT BEZELS



1947-53 Chevy & GMC Truck

STAINLESS STEEL PARKING LIGHT BEZEL

- Polished stainless steel
- Sold individually

C475307



1947-53 Chevy & GMC Truck

CHROME PARKING LIGHT BEZEL

- Chrome plated
- Sold individually

C475307CR



1962-66 Chevy & GMC Truck

PARKING LIGHT BEZEL

- Sold individually

C626601



PARKING GASKETS



1960-66 Chevy Truck

FRONT PARKING LIGHT LENS GASKET

- Great looking OEM style replacement lens
- Injection molded from high quality polycarbonate plastic

C606612



1971-72 Chevy Truck

FRONT PARKING LIGHT LENS GASKET

- Sold in pairs

C717201



1967-68 Chevy & GMC Truck

FRONT PARKING LIGHT LENS GASKET

- Black foam rubber like the original
- Sold individually

C676812



1947-53 Chevy & GMC Truck

FRONT PARKING LIGHT LENS GASKET

- Black foam rubber like the original
- Sold individually

C475308



1951-53 GMC Truck

FRONT PARKING LIGHT LENS GASKET, LENS

- Black foam rubber like the original
- Sold in pairs

C515321 | Lens Gasket

C515301 | Lens

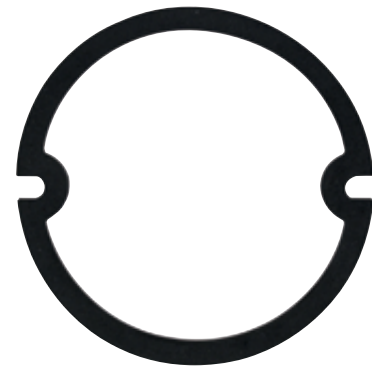

1955-57 Chevy & GMC Truck

FRONT PARKING LIGHT LENS GASKET

- Black foam rubber like the original
- Sold in pairs

C555755

SIDE MARKERS



SIDE MARKERS



1968-72 Chevy Truck

18 LED SIDE MARKER LIGHT W/ STEEL TRIM

- 18 super bright LEDs, complete with polycarbonate lens
- Epoxy coated fully sealed electronics
- Solid state circuit boards are designed for 7.7 - 14.0 VDC
- Dual function, parking light and turn signal

CML6872A | Front Amber

CML6872R | Rear Red

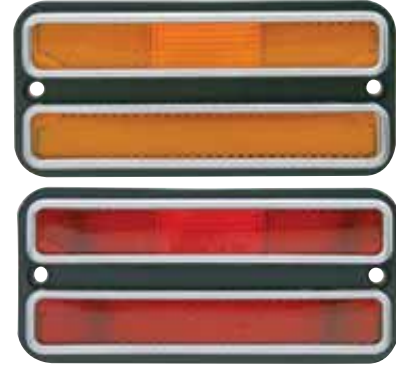

1968-72 Chevy & GMC Truck

SIDE MARKER LIGHT W/ STEEL TRIM

- Deluxe side marker lamp lens with stainless steel trim
- Also fits Blazer, Jimmy and Suburban
- Gasket included, sold individually

C687202 | Front Amber

C687203 | Rear Red

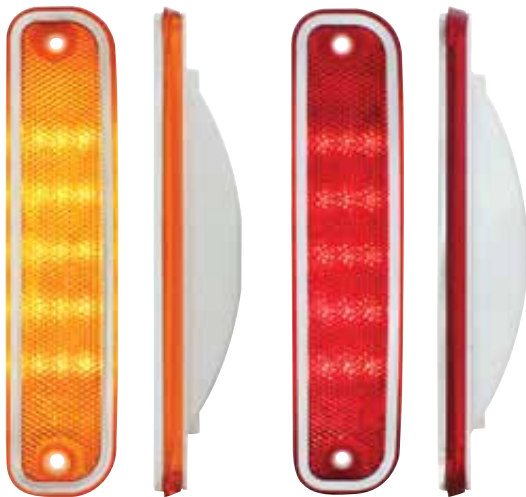

1973-80 Chevy & GMC Truck

LED FRONT SIDE MARKER LIGHT

- Polycarbonate lens with stainless steel trim
- Fits LH/Driver and RH/Passenger
- Sold individually

CML7380A | Amber

CML7380R | Red



1973-80 Chevy & GMC Truck

SIDE MARKER LIGHT W/ STAINLESS STEEL TRIM

- Polycarbonate lens with polished deluxe stainless steel trim
- Also fits 1973-91 Chevy & GMC Crew Cab Dually
- Fits LH/Driver and RH/Passenger side
- Sold individually

C738002 | Amber Side Marker Light

C738003 | Red Side Marker Light

C738001 | Clear Side Marker Light



1967-91 Chevy & GMC Truck

SIDE MARKER SOCKET

- Replaces damaged or missing OE sockets
- Includes butt connectors
- 194 bulb sold separately

C679101 | Side market socket kit

39043 | Two 194 clear bulbs

MISC. LIGHTS / LENS



MISC. LIGHTS / LENS



Universal

1004 DOME LIGHT BULB

- Single filament
- Sold individually

39065



1969-72 Chevy & GMC Truck

CARGO LIGHT LENS

- Great looking OEM style replacement lens
- Injection molded from high quality polycarbonate plastic

110168



1955-59 Chevy Truck

DOME LIGHT LENS

- Sold individually

C555901



1969-72 Chevy & GMC Truck

18 LED 3RD BRAKE & CARGO LIGHT

- 18 white LED cargo light with 9 red LED 3rd brake light feature
- Plug & play with 1004 double contact plug like the original
- Third brake light requires additional wiring, wiring instructions included
- Epoxy coated, fully sealed electronics
- Energy efficient solid state circuit board engineered for 12 VDC systems

110127



1969-72 Chevy & GMC Truck

INCANDESCENT CARGO LIGHT ASSEMBLY

- Great looking OEM style replacement lens
- Injection molded from high quality polycarbonate plastic

110446



1969-72 Chevy & GMC Truck

CARGO LIGHT GASKET

- White foam rubber like the original
- Also fits 1969 Camaro backup light

110217

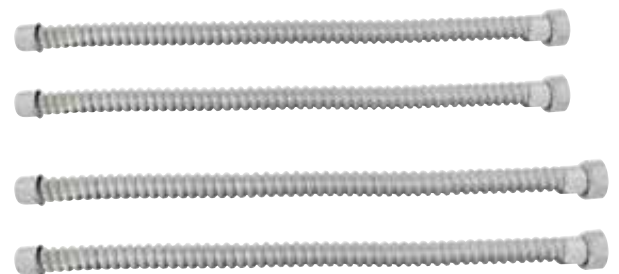

Universal

STAINLESS STEEL TAIL LIGHT WIRE CONDUIT

- Sold in pairs

C5025 | 12"

C5026 | 19"

CARGO / LICENSE LIGHT



1940-53 Chevy Truck

6 LED AUXILIARY/LICENSE LIGHT

- 6 super bright white LEDs
- Epoxy coated, fully sealed electronics
- Energy efficient solid state circuit board engineered for 7.7-14.0 VDC systems

CTL4053LL



1940-43 Chevy Truck

LICENSE LIGHT LENS GASKET

- Also fits 1937-38 Chevy car

C7001G



1940-53 Chevy & GMC Truck

CLEAR TAIL LIGHT LICENSE LENS

- Approximately 2 5/16" wide, 1 7/16" tall, 7/8" depth
- Sold individually

C7021



Universal

2 LED AUXILIARY/LICENSE LIGHT

- 2 super bright LED auxiliary/license light, water resistant with chrome housing
- 2 wires, (hard wired), hole distance 3 1/2" center to center

39994B



Universal

1 LED LICENSE PLATE FASTENER (2 PACK)

- Stainless steel fastener with super bright LED
- 8 1/2" wire lead, 2 wires (hard wired)
- Requires 5/16" diameter hole for installation

70300 | Amber

70301 | Blue

70302 | Red

70303 | White

LICENSE PLATE BRACKET W/ LIGHT



1954-59 Chevy & GMC Truck

REAR LICENSE PLATE BRACKET W/ LIGHT

- Die stamped with high quality 17 gauge sheet metal
- Original style license plate light with quality glass & metal enclosure, original style large riveted license plate bracket
- Single positive lead wire with quick connector pre-installed electrical hookup
- Black EDP coated

110770



1960-66 Chevy Truck

REAR LICENSE PLATE BRACKET W/ LIGHT

- Die stamped with high quality 17 gauge sheet metal
- Original style license plate light with quality glass enclosure enclosure, original style large riveted license plate bracket
- Single positive lead wire with quick connector pre-installed electrical hookup, black rubber insert to reduce rattling noise from license plate
- Black EDP coated

110771

FRONT BUMPERS



1947-72 Chevy & GMC Truck

CHROME FRONT BUMPERS

- Quality heavy stamped steel bumpers with all original detail and mounting holes
- Chrome plated

105471 | 1947-54 Chevy & GMC Truck

105551 | 1955-59 Chevy & GMC Truck

105601 | 1960-62 Chevy & GMC Truck

105631 | 1963-66 Chevy & GMC Truck

105671 | 1967-70 Chevy & 1967-68 GMC Truck

105672 | 1969-72 GMC Truck

105711 | 1971-72 Chevy Truck



1938-46 Chevy Truck

STAINLESS STEEL BUMPER BOLT

- 1/2-13 thread

C383901

REAR BUMPERS

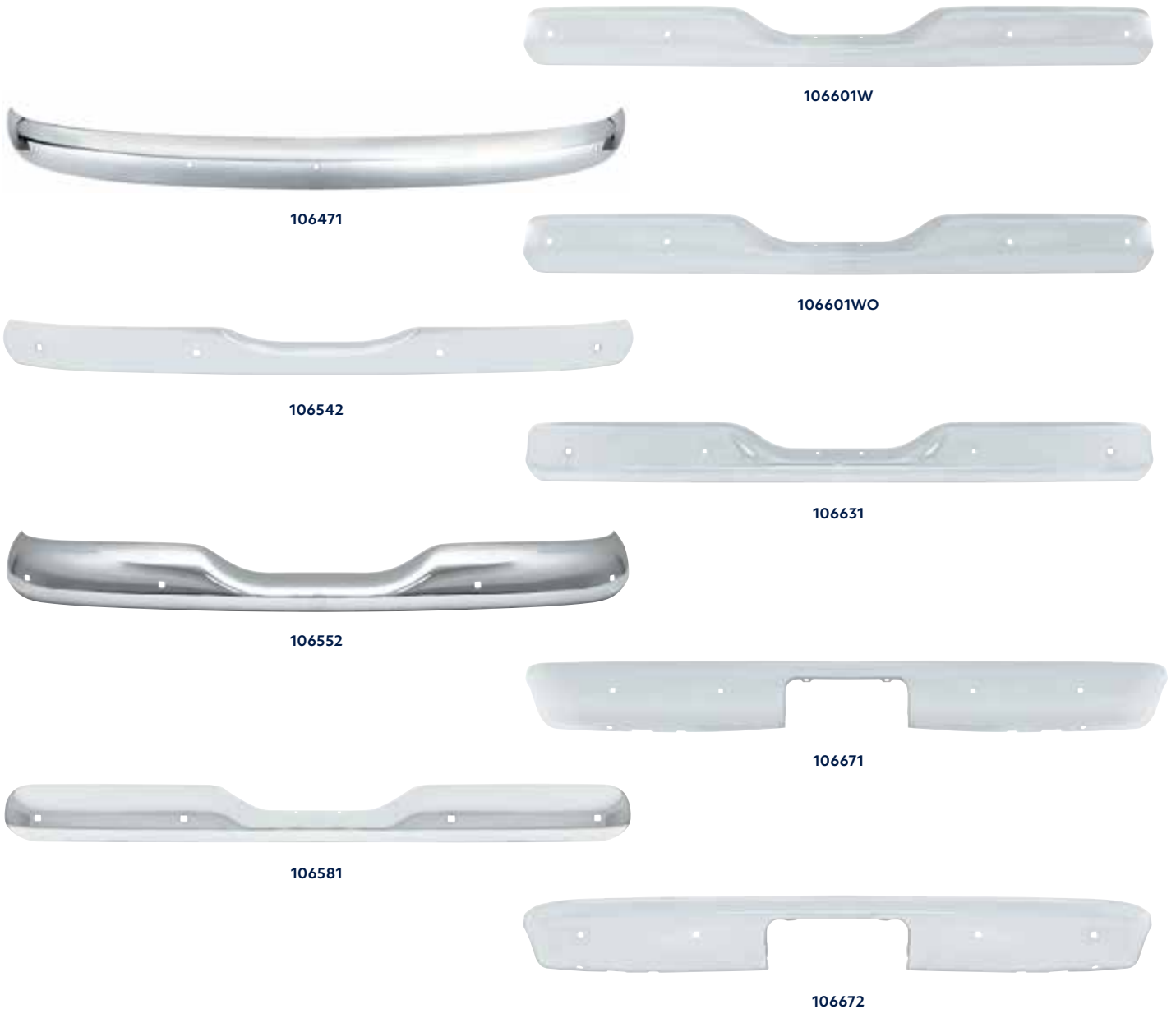

1947-72 Chevy & GMC Truck

CHROME REAR BUMPERS

- Quality heavy stamped steel bumpers with all original detail and mounting holes
- Chrome plated

106471		1947-53	Chevy & GMC Truck
106542		1954-55	Chevy & GMC Truck
106552		1955-59	Chevy & GMC Stepside Truck
106581		1958-59	Chevy Fleetside Truck
106601W		1960-62	Chevy & GMC Fleetside Truck
106601WO		1960-62	Chevy & GMC Fleetside Truck
106631		1963-66	Chevy & GMC Fleetside Truck
106671		1967-72	Chevy & GMC Fleetside Truck
106672		1962-87	Chevy & GMC Stepside Truck



1947-72 Chevy Truck

CHROME BUMPER BOLT

- 1/2-13 thread
- 1 Piece, includes flat washer, lock washer and nut

C477204

FRONT BUMPERS



110729



110728



110721



110722



110718



110719



110720

1947-72 Chevy & GMC Trucks

BLACK EDP COATED FRONT BUMPERS

- Quality heavy stamped steel bumpers with all original detail and mounting holes
- Black EDP coated finish

110729 | 1947-55 Chevy & GMC Truck

110728 | 1955-59 Chevy & GMC Truck

110721 | 1960-62 Chevy & GMC Truck

110722 | 1963-66 Chevy & GMC Truck

110718 | 1967-70 Chevy, 1967-68 GMC

110719 | 1967-72 GMC Truck

110720 | 1970-72 Chevy Truck

REAR BUMPERS



110730



110731



110726



110724



110725



110733

1947-72 Chevy & GMC Trucks

BLACK EDP COATED REAR BUMPERS

- Quality heavy stamped steel bumpers with all original detail and mounting holes
- Black EDP coated finish

110730 | 1947-53 Chevy & GMC Truck

110731 | 1954-55 Chevy & GMC Truck

110726 | 1955-59 Chevy & GMC Stepside Truck

110724 | 1960-62 Chevy & GMC Fleetside Truck

110725 | 1963-66 Chevy & GMC Truck

110733 | 1967-72 Chevy & GMC Fleetside Truck



1947-53 Chevy & GMC Truck

CHROME GRILLE GUARD

- Chrome grille guard with chrome hardware
- Mounts behind front bumper, fits up to 6' wide bumpers

C475313



1955-56 Chevy Truck

CHROME GRILLE

- Steel reproduction of the original truck grille
- Beautiful triple chrome plating

110387



1955-56 Chevy Truck

BLACK PAINTED GRILLE

- Quality 19 gauge steel reproduction, black EDP finish
- Has all original bar spacing and contour
- Includes 5/16-18 square nuts for quick and easy installation

110388



1957 Chevy Truck

CHROME GRILLE

- Steel reproduction of the original truck grille
- Beautiful triple chrome plating

110389



1957 Chevy Truck

WHITE POWDER COATED GRILLE

- Excellent steel reproduction of the original truck grille
- Includes 5/16-18 nuts pre-welded to grille for quick and easy installation
- Powder coated with original factory color look

110390

HOOD PARTS



1947-54 Chevy Truck

CHROME HOOD LATCH PANEL

- Heavy duty triple chrome plated stamped steel
- Has radiator, fender, and grille bar mounting bolt holes
- Includes pre-installed hood latch

110340



1947-54 Chevy Truck

BLACK EDP COATED HOOD LATCH PANEL

- Die stamped 18 gauge steel
- Has radiator, fender, and grille bar mounting bolt holes
- Includes pre-installed hood latch

110339



1955-57 Chevy Truck

HOOD LATCH PANEL

- Made with high quality 20 gauge sheetmetal
- Features all original contour and detail
- Black EDP coated

110341



1958-59 Chevy Truck

HOOD LATCH PANEL

- Stamped steel reproduction of the original
- Has radiator, fender, and grille bar mounting bolt holes
- Black EDP coated

110342



1947-54 Chevy & GMC Truck

HOOD SAFETY CATCH

- Die stamped steel, spring loaded like the original
- Black EDP coated
- Also fits 1955 1st series

110279

HOOD PARTS

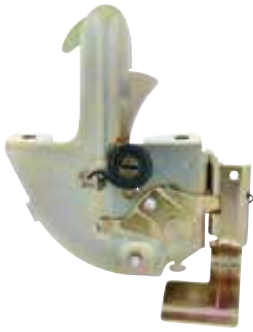

1955-57 Chevy & GMC

HOOD LATCH ASSEMBLY

- Die stamped with heavy gauge sheetmetal
- Zinc plated
- Sold in pairs

110280

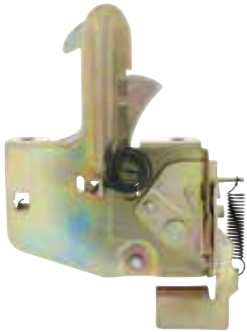

1958-59 Chevy & GMC

HOOD LATCH ASSEMBLY

- Die stamped with heavy gauge sheetmetal
- Features all the original mechanical design
- Pre-assembled for easy installation

110281



1947-55 Chevy & GMC Truck

1st SERIES TRUCK HOOD HINGE AND SUPPORT

- Heavy duty steel reproduction of the original hood hinge
- Includes hood support arm with clock spring
- Black EDP coated
- Sold individually, please specify driver or RH/Passenger

110249 | L/H

110250 | R/H



Chevy 327/350 Motor

CHROME 45 DEGREE WATER NECK

- Straight forward, 45 degree up chrome water neck
- Quality zinc die-cast with beautiful chrome plated finish
- Comes complete with thermostat housing, bolts and o-ring

110344



Chevy Small Block Gen 1 & GM V6

CHROME 15 DEGREE WATER NECK

- Angled left 15 degree up chrome water neck
- Quality zinc die-cast with beautiful chrome plated finish
- Comes complete with thermostat housing, bolts and o-ring

110345

BATTERY HOLD DOWN FRAMES



1955-59 Chevy Truck

BATTERY HOLD DOWN BOLT SET

- Clear zinc plated hold down bolts with washers, and nuts
- Sold in pairs

110807



1958-66 Chevy & GMC Truck

BATTERY HOLD DOWN BRACKET

- High grade 304 stainless steel
- Identical design of the original

110473

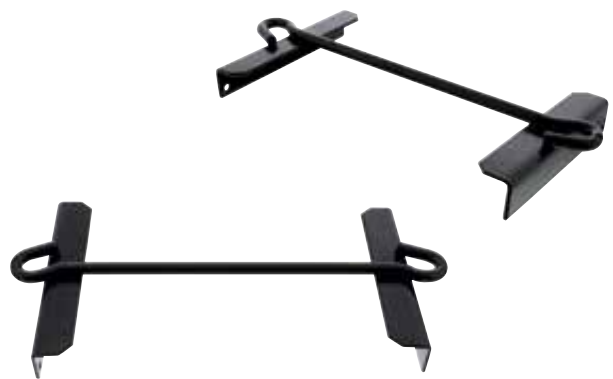

1958-66 Chevy & GMC Truck

BATTERY HOLD DOWN BRACKET

- Excellent reproduction of the original design
- Die stamped steel
- Anti-Corrosive black powder coated finish

110472



1947-55 Chevy & GMC Truck

BATTERY TRAY HOLD DOWN FRAME

- Excellent reproduction of the original design
- Die stamped steel, painted black

110470



1955-57 Chevy & GMC Truck

BATTERY HOLD DOWN FRAME

- Excellent reproduction of the original design
- Die stamped steel, painted black
- Fits group-24 battery size

110471

BATTERY TRAYS



C475501



C555711



C585911



C606604



C677203



C677212

1967-72 Chevy & GMC Truck

BATTERY TRAYS

- Heavy duty stamped steel
- Black powder coated

C475501 | 1947-55

C555711 | 1955-57

C585911 | 1958-59

C606604 | 1960-66

C677203 | 1967-72

C677212 | 1967-72

C738011 | 1973-80



C738011

EXTERIOR MIRROR KITS



EXTERIOR MIRROR KITS

1970-72 Chevy & GMC Truck

EXTERIOR MIRROR WITH LED TURN SIGNAL

- Winner NSRA safety product of the year
- 9 red LED arrow hidden inside mirror glass
- Polished stainless steel mirror head & chrome plated arm
- Mounting hardware included
- Easy hookup, route wire through door jamb and connect to front turn signal wires under dash near steering column
- Can also be used on older 1967-69 trucks

110749 | Bundle LH and RH Included

C707201-LED | LH/Driver

C707202-LED | RH/Passenger



1973-87 Chevy & GMC Truck

CONVEX EXT. MIRROR W/ LED TURN SIGNAL RH

- LED turn signal arrow hidden inside mirror glass
- Beautiful die-cast & chrome plated mirror head and arm
- Convex mirror for wide angle visibility
- Easy hookup, route wire through door jamb and connect to front turn signal wires under dash near steering column
- Includes mounting pad, mounting bracket and screws

C738710-CVXLED | RH/Passenger Convex

C738710-LED | LH/Driver

EXTERIOR MIRROR KITS



1970-72 Chevy & GMC Truck

EXTERIOR MIRRORS

- Convex mirror with wide angle optics for RH side
 - Polished stainless steel mirror head & chrome plated arm
 - Mounting pads and hex wrench included
 - Bundle includes: C707201 & C707202 pre-packed in one box
- 110748 | Bundle LH and RH Included**
C707201 | LH/Driver
C707202 | RH/Passenger



1973-87 Chevy & GMC Truck

CONVEX EXTERIOR MIRROR

- Chrome finish
 - Also fits 1951-52 Chevy passenger car
- C738710-CVX**



1973-87 Chevy & GMC Truck

EXTERIOR MIRROR KIT

- Hardware included
 - Fits LH/Driver or RH/Passenger, sold individually
- C738710**

EXTERIOR MIRROR KITS

Universal

4" PEEP MIRROR WITH LED TURN SIGNAL

- 7 red LED arrow hidden behind mirror glass
- Wiring is discreetly routed through groove in arm
- Polished stainless steel mirror head with chrome plated arm
- Mounting pad and hex wrench included
- 12V only, includes 48" of wire
- Bundle includes: C5001-led & C5001-1CVXLED pre-packed in one box

110743 | Mirror Bundle

C5001-LED | LED Mirror

C5001-CVXLED | Convex LED Mirror



Universal

4" CURVED ARM PEEP MIRROR

- Polished stainless steel mirror head with chrome plated arm
- Convex mirror has Improved wide angle vision on passenger side
- Mounting pad and hex wrench included
- Sold individually

C5001



Universal

4" CURVED ARM CONV. PEEP MIRROR BUNDLE

- Polished stainless steel mirror head with chrome plated arms
- Convex mirror has Improved wide angle vision on passenger side
- Mounting pad and hex wrench included
- Bundle includes: C5001 & C5001-CVX pre-packed in one box

110742 | Mirror Bundle



Universal

3" CURVED ARM CONV. PEEP MIRROR BUNDLE

- Polished stainless steel mirror head with chrome plated arms
- Convex mirror has Improved wide angle vision on passenger side
- Mounting pad and hex wrench included
- Bundle includes: C5001-1 & C5001-1CVX pre-packed in one box

110741 | Mirror Bundle

C5001-1 | Standard Mirror

C5001-1CVX | Convex Mirror



EXTERIOR MIRROR KITS



EXTERIOR MIRROR KITS



1973-91 Chevy & GMC Full Size Truck & Van

MIRROR

- Exterior rectangular rear view mirror with chrome housing
- Includes mounting pad and mounting hardware
- Sold individually

60050



Universal

STAINLESS SWING AWAY MIRROR

- Low mount stainless steel truck mirror housing, arms and yoke
- Fits most pickups, vans, smaller RVs and campers
- Extends to 15", double strength tubing reduces vibration
- Swing-away function helps vehicle fit into tight parking spots

60039

EXTERIOR MIRROR HEADS



C477201



C476903B



C476901



C477202



1947-55 Chevy & GMC Truck

5" EXTERIOR MIRROR HEAD

- Gloss powder coated mirror, 1/4" male stud on back
- Sold individually

C477201 | Black, Ribbed

C476901 | Chrome, Ribbed

C476903B | Black, Smooth

C477202 | Chrome, Smooth



C476902



C476904



1947-72 Chevy & GMC Truck

EXTERIOR MIRROR HEAD

- 6"x8" mirror head, 1/4 - 20 male stud with nut
- Sold individually

C476902 | Stainless Steel

C476904 | Black

EXTERIOR MIRROR ARMS



C475510



C475511



C475512



C475513



C555941



C555942



C555943



C555944

1947-55 Chevy & GMC Truck

EXTERIOR MIRROR ARM

- Die-cast exactly like the original
- Chrome mirror heads available separately, C476901, C477202
- Black mirror heads available separately, C477201, C476903B

C475510 | RH/Passenger | Powder Coated Black

C475511 | LH/Driver | Chrome

C475512 | RH/Passenger | Powder Coated Black

C475513 | LH/Driver | Chrome

1955-59 Chevy & GMC 2nd Series Truck

EXTERIOR MIRROR ARM

- Die-cast exactly like the original
- Fits all 2nd series trucks, Panel truck, and Suburban
- Chrome mirror heads available separately, C476901, C477202
- Black mirror heads available separately, C477201, C476903B

C555941 | LH/Driver | Powder Coated Black

C555942 | RH/Passenger | Powder Coated Black

C555943 | LH/Driver | Chrome

C555944 | RH/Passenger | Chrome

WIPER BLADES

Universal

ELECTRIC WIPER MOTOR SET

- Stainless steel wiper arm, 11" long blade and built-in switch on black motor cover
- Approximately 110 degree swing
- 1 3/4" center shaft to side hold mounting
- 3 1/4" long threaded shaft

A6235



Universal

ELECTRIC WIPER MOTOR SET

- Electric wiper motor set, stainless with wiper arm & blade
- 12 volt with self park, neoprene stem seal
- 1 3/4" center shaft to side hold mounting
- 3 1/4" long threaded shaft

A6236



Universal

WIPER BLADES

- Hook style, polished stainless steel wiper blades
- Sold individually

A7026 | 8"

A7037 | 9"

A7027 | 10"



Universal

WIPER BLADES

- Wrist style, polished stainless steel wiper blades
- Used with wiper arms with spoon shape ends
- Sold individually

110300 | 6"

110301 | 8"

110302 | 9"

110303 | 10"

110304 | 11"

110305 | 12"

110306 | 15"



WIPER ARMS / LINKAGE

1947-72 Chevy & GMC Truck

WIPER ARMS

- Polished stainless steel with die-cast chrome plated mounts
- Item #: 190671, and 190672 have bayonet end and use 15" wiper blade item #: 110306
- Sold individually

190471 | 1947-53 Truck | LH/Driver

190472 | 1947-53 Truck | RH/Passenger

190541 | 1954-59 Truck | LH/Driver

190542 | 1954-59 Truck | RH/Passenger

190601 | 1960-66 Truck | LH/Driver

190602 | 1960-66 Truck | RH/Passenger

190671 | 1967-72 Truck | LH/Driver or RH/Passenger Side



190471



190472



190541



190542



190601



190602



190671



190672

1960-66 Chevy & GMC

WIPER TOWER & LINKAGE SET

- Complete wiper linkage set with die-cast wiper shaft towers, pivots, and link arms
- Sold as a set

110243



REAR VIEW MIRRORS



Universal

INTERIOR REAR VIEW MIRROR

- Rectangular stainless steel rear view mirror
 - Easy installation, simply glue onto windshield glass
 - Recommended adhesive: Loctite 37438, Permatex 81840, 3M 08752
- M1003**



Universal

INTERIOR REAR VIEW MIRROR

- Rectangular chrome plated aluminum rear view mirror
 - Easy installation, simply glue onto windshield glass
 - Recommended adhesive: Loctite 37438, Permatex 81840, 3M 08752
- 70801**

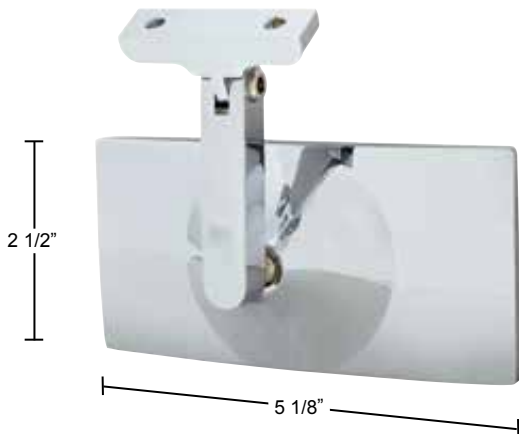

Universal

INTERIOR REAR VIEW MIRROR

- Rectangular chrome plated aluminum rear view mirror
 - Easy installation, simply glue onto windshield glass
 - Recommended adhesive: Loctite 37438, Permatex 81840, 3M 08752
- 70803**

REAR VIEW MIRRORS



Universal

INTERIOR REAR VIEW MIRROR

- Oval chrome plated aluminum rear view mirror
- Easy installation, simply glue onto windshield glass
- Recommended adhesive: Loctite 37438, Permatex 81840, 3M 08752

70804



Universal

INTERIOR REAR VIEW MIRROR

- Oval chrome plated aluminum rear view mirror
- Easy installation, simply glue onto windshield glass
- Recommended adhesive: Loctite 37438, Permatex 81840, 3M 08752

70802

REAR VIEW MIRRORS



1947-53 Chevy & GMC Truck

INTERIOR REAR VIEW MIRROR

- Chrome finish
- Also fits 1951-52 Chevy passenger car

C475310CR



1947-59 Chevy & GMC Truck

INTERIOR REAR VIEW MIRROR

- Polished stainless steel housing, mirror glass installed in housing with smooth edges

C475902



1953-59 Chevy & GMC Truck

INTERIOR REAR VIEW MIRROR

- Chrome finish
- Also fits 1953-54 GM passenger car

C535910CR

REAR VIEW MIRRORS



1960-71 Chevy & GMC Truck

INTERIOR REAR VIEW MIRROR

- Polished stainless steel housing, mirror glass installed in housing with smooth edges
- Mirror arm sold separately, C607111

C607110



1953-59 Chevy & GMC Truck

CHROME INSIDE MIRROR HOUSING

- Chrome finish
- Also fits 1953-54 GM passenger car

C475310



1960-71 Chevy & GMC Truck

REAR VIEW MIRROR BRACKET

- Chrome finish

C607111



1960-71 Chevy & GMC Truck

INTERIOR MIRROR BRACKET SCREW

- Polished stainless steel mirror screw

C607112



1947-53 Chevy & GMC Truck

INTERIOR MIRROR BRACKET

- Shaped exactly like the original, polished stainless steel
- Mounts on windshield division bar
- Use with United Pacific mirrors or C475310CR

C475351



GAUGE PACKAGES



GAUGE PACKAGES BY



1955-59 Chevy Truck

TACH FORCE STYLE GAUGE PACKAGE

- Six in one package (Fuel 0-30 OHM)

110019

1947-72 Chevy & GMC

SPEEDOMETER CABLE

- 68" speedometer cable

C477203



1967-72 Chevy

G-STOCK GAUGE PACKAGE

- 5" Speed/Tach, four 2 1/8" gauge (Fuel 0-90 OHM)

110020



1947-53 Chevy & GMC

VINTAGE STYLE GAUGE PACKAGE

- 5" Speed/Quad (Fuel 240-330hm)

110017

1954-55 Chevy & GMC

TRADITIONAL STYLE GAUGE PACKAGE

- 5" Speed/Tach/Quad (Fuel 240-330hm)

110018

DASH KNOBS



1947-54 Chevy & GMC Truck HEADLIGHT ROD & KNOBS

- Exact design as original

C475321 | 1947-53 | Maroon
C545521 | 1954-55 | Black
C555921 | 1955-59 | Chrome
C606321 | 1960-63 | Black
C646621 | 1964-66 | Black



1968-72 Chevy & GMC Truck WIPER SWITCH KNOBS

- High quality plastic injection molded with durable polypropylene plastic
 - Deluxe style with stainless steel center insert
 - Original style "D" profile mounting hole, set screw included
- 110700**



1947-66 Chevy & GMC Truck

WIPER SWITCH KNOBS

- Original wiper switch design made of durable plastic with high quality chrome plating

C475309C | 1947-53 | Chrome
C475309M | 1947-53 | Maroon
C555931 | 1955-59 | Chrome
C606331 | 1960-63 | Black/Stainless Steel
C646631 | 1964-66 | Black/Stainless Steel

1968-72 Chevy & GMC Truck WIPER SWITCH KNOBS

- High quality plastic injection molded with durable polypropylene plastic
 - Deluxe style with stainless steel center insert
 - Original style "D" profile mounting hole, set screw included
- 110701**

KNOBS / CABLES / ETC.



1947-59 Chevy & GMC

CHOKE CABLE AND KNOB

- Stainless steel cable

C475302 | 1947-53 | Stainless Steel w/ Maroon Knob
C555905 | 1955-59 | Stainless Steel w/ Chrome Knob



1947-59 Chevy & GMC

THROTTLE CABLE AND KNOB

- Stainless steel cable

C475301 | 1947-53 | Stainless Steel w/ Maroon Knob
C555904 | 1955-59 | Stainless Steel w/ Chrome Knob



1947-72 Chevy & GMC

SPEEDOMETER CABLE

- 68" speedometer cable

C477203



SWITCHES / FLASHER



Universal

CHROME TURN SIGNAL SWITCH

- 7 wire system, comes with adjustable clamp to hold onto the steering column, no drilling required
- Indicator light at the end of the turn signal handle
- Inline fuse and wiring diagram included, ready to use for 12V systems, also works for 6V if indicator bulb is changed to 6V

A5007



Universal

HEAVY DUTY TURN SIGNAL SWITCH

- All metal chrome plated heavy duty switch with 7 wires
- Clamp onto hold steering column
- Turn signal indicator lights, 4-way emergency hazard function with red light
- Includes in-line fuse and wiring diagram
- Ready to use for 12 volt systems, also works for 6 volt if indicator bulb is changed to 6 volt

5007R



Universal

TURN SIGNAL SWITCH W/ 4 WAY HAZARD

- Chrome plated housing, clamps onto steering wheel
- 4 way hazard switch
- Lighted direction indicators

110307



1947-59 Chevy & GMC Truck

HEADLIGHT SWITCH

C475502 | 1947-55 | 6 Volt, 1st Series

C475901 | 1947-59 | 12 Volt



Universal

6 VOLT TURN SIGNAL FLASHER

- For all 6 volt positive and negative ground applications
- 3 terminal, 535 type
- Has "P" terminal for single dash indicator light
- Use with turn signal switches 5007R or A5007 on 6 volt vehicles
- Must use load resistor PN 34205 (need 2) when used with 6 volt LED lights

110252



Universal

IGNITION SWITCH W/ TWO KEYS

- Universal, 4 positions (ACC, OFF, IGN/ACC, IGN/START)
- Knurled aluminum mounting nut, mounts in 3/4" hole
- Stud terminal posts with nuts

S1204

SWITCHES / SHIFT KNOBS



Universal

BATTERY DISCONNECT SWITCH

- Prevents dead batteries, theft, and provides a safer work environment with the battery disconnected
- Heavy duty metal housing with die-cast knob

S1201 | 250A Continuous, 450A Momentary

S1202 | 350A Continuous, 500A Momentary



Universal

CHROME T-SHIRT KNOB

- Custom chrome t-shirt knob, perfect for vintage Chevy, Ford, and Mopar
- 5/16 - 24 thread adapter

110289



Universal

CHROME DAGGER SHIFT KNOB

- High quality chrome finish with machined grip
- Universal hex screw mount, includes mounting hardware

70677 | Dagger

70679 | Skull



Universal

DAGGER AIR VALVE KNOB

- Works as a dipstick handle with adapter removed
- Universal hex screw mount, includes mounting hardware

23529 | Black

23525 | Chrome

STEERING COLUMNS BY



1960-66 Chevy & GMC

MILL FINISH STEERING WHEEL COLUMN

- Design to fit the original dash mount
- Accepts the original rag joint flange or factory steering shaft
- The classic applications use our 2" diameter column to match the existing mounting holes
- Polished stainless steel

110052



1960-66 Chevy & GMC

TILT STEERING WHEEL COLUMN

- Design to fit the original dash mount
- Accepts the original rag joint flange or factory steering shaft
- The classic applications use our 2" diameter column to match the existing mounting holes
- Polished stainless steel

110050



1960-66 Chevy & GMC

MILL FINISH STEERING WHEEL COLUMN

- Mill finish steering column with late power steering
- Designed to fit the original dash mount
- Accepts the original rag joint flange or factory steering shaft
- The classic applications use our 2" diameter column to match the existing mounting holes

110051



1960-66 Chevy & GMC

MILL FINISH STEERING WHEEL COLUMN

- Design to fit the original dash mount
- Accepts the original rag joint flange or factory steering shaft
- The classic applications use our 2" diameter column to match the existing mounting holes

110049



1960-66 Chevy & GMC Truck

FLOOR SHIFT TILT COLUMN

- Use with late model power steering box
- Tilt column includes slip shaft and correct universal joint
- Polished stainless steel

110264



1967-72 Chevy & GMC Truck

30" TILT & SHIFT STEERING COLUMN

- GM 30" tilt column shift steering column with ignition key lock
- Ignition key switch is on the column, 2 keys included
- 30" Long, 3/4", 36 spline shaft accepts most GM original rag joint coupler flange
- 2" diameter column includes GM style ignition switch and turn signal switch, paintable mill finish stainless steel

110317

COLUMN / HUB ADAPTER / HORN



Early GM Models

30" MILL FINISH STEERING WHEEL COLUMN

- 30" column shift tilt column with neutral safety switch
- Complete with gearshift knob, billet dress up kit (tilt, turn signal levers and hazard knob)
- Illuminated gearshift indicator and GM wiring (4-14" connector) and removable 12-position linkage arm

110403



1949-80 GMC

STEERING WHEEL HUB ADAPTER KIT

- Use with 3-bolt mount steering wheels
- Fits wide variety of GM vehicles 1949-80
- Includes splined hub, horn contact plate and hardware
- Horn button cap sold separately

110314



Universal

HORN BUTTON

- Satin finish with black button
- Two screw electrical terminals, mounting screws included

40028



1967-72 Chevy Truck

CHROME HORN BUTTON CAP W/ BOWTIE

- Chrome horn button with bowtie logo

C677251



1967-68 Chevy Truck

CHROME HORN BUTTON CAP

- Chrome horn button cap with Chevrolet division markings

C676851

STEERING WHEELS



STEERING WHEELS



Universal

15" WOODGRAIN STEERING WHEEL

- 15" woodgrain steering wheel for 3-bolt hubs
- Wood grip with finger grooves and aluminum rivets
- 304 stainless steel spokes, dish depth 4"
- Compatible with all 3-bolt steering wheel hub kits on the market
- Hub adapter and horn button kit sold separately

110794



Universal

14" CHROME 3-SPOKE STEERING WHEEL

- 14" chrome aluminum 3-spoke style 9-screw mount steering wheel
- Comfortable black leather grip
- Requires standard 9-screw steering wheel hub adapter and horn button kit, sold separately

88300



Universal

14" CHROME 3-SPOKE STEERING WHEEL

- 14" chrome aluminum steering wheel
- Comfortable black leather grip
- Requires standard 9-screw steering wheel hub adapter and horn button kit, sold separately

88301



Universal

14" CHROME BLADE STEERING WHEEL

- 14" chrome aluminum blade style steering wheel
- Comfortable black leather grip
- Requires standard 9-screw steering wheel hub adapter and horn button kit, sold separately

88302



Universal

14" CHROME SCORPION STEERING WHEEL

- 14" chrome aluminum scorpion style steering wheel
- Comfortable black leather grip
- Requires standard 9-screw steering wheel hub adapter and horn button kit, sold separately

88304

GLOVE BOX / BRAKE COVER / ETC.



1967-68 Chevy & GMC Truck

CHROME HAND BRAKE COVER

- Original accessory fits below steering column to dress up the hand brake
 - Stamped steel like the original and beautifully chrome plated
- C676802**



1955-59 Chevy & GMC Truck 2nd Series

GLOVE BOX DOOR KIT

- High quality 22 gauge steel sheet metal
- Heavy gauge arm brackets with 10-32 tapped holes
- 10-24 caged nuts for quick hinge mounting
- 10-32 & 10-24 screws included

110338



1960-66 Chevy & GMC Truck

GLOVE BOX HINGE BUSHING

- OD 0622", ID 0275", Thickness 0298"

110402



1947-55 Chevy 1st Series Truck

PEDAL PAD

- Identical size and shape as original
- C7018**



1967-72 Chevy Truck

BRAKE & CLUTCH PEDAL PAD & TRIM

- Rubber pad and stainless trim sold separately

C677210 | Rubber pad

C677211 | Stainless trim

A/C VENTS / DEFROST DUCTS



1967-72 Chevy & GMC Truck

A/C CENTER VENT

- High quality die-cast zinc and chrome plated
- Mounting hardware not included

110582



1967-72 Chevy & GMC Truck

A/C VENT BALL

- High quality die-cast zinc and chrome plated
- Sold individually, fits LH/Driver or RH/Passenger

C677214



1967-72 Chevy & GMC Truck

DEFROSTER DUCTS

- Injection molded plastic same as the original

C677215 | LH/Driver | Black

C677216 | RH/Passenger | Black

C677217 | LH/Driver | Chrome

C677218 | RH/Passenger | Chrome

VENT WINDOWS



1951-55 Chevy & GMC Truck

VENT WINDOW ASSEMBLY

- Complete assembled vent window, includes glass, chrome vent frame, chrome vent handles, rubber vent seal, division bar with felt, and brackets
- Sold individually, please specify LH/Driver or RH/Passenger

120511 | LH/Driver | No Tint
 120512 | RH/Passenger | No Tint
 120513 | LH/Driver | Tinted
 120514 | RH/Passenger | Tinted



1951-55 Chevy & GMC Truck

VENT WINDOW ASSEMBLY

- Complete assembled vent window, includes glass, chrome vent frame, chrome vent handles, rubber vent seal, division bar with felt, and brackets
- Sold individually, please specify LH/Driver or RH/Passenger

120641 | LH/Driver | No Tint
 120642 | RH/Passenger | No Tint
 120643 | LH/Driver | Tinted
 120644 | RH/Passenger | Tinted

1967-72 Chevy & GMC Truck

VENT WINDOW ASSEMBLY

- Complete assembled vent window, includes glass, chrome vent frame, chrome vent handles, rubber vent seal, division bar with felt, and brackets
- Sold individually, please specify LH/Driver or RH/Passenger

120671 | LH/Driver | No Tint
 120672 | RH/Passenger | No Tint
 120673 | LH/Driver | Tinted
 120674 | RH/Passenger | Tinted

VENT FRAME / GLASS CHANNEL



1951-55 Chevy & GMC Truck

CHROME VENT WINDOW FRAME

- Beautiful show ready triple chrome plated finish
- Mounting stud with threaded end for easy installation
- Sold in pairs

122511



1960-63 Chevy & GMC Truck

CHROME VENT WINDOW FRAME

- Beautiful show ready triple chrome plated finish
- Mounting stud with threaded end for easy installation
- Sold in pairs

122601



1964-66 Chevy & GMC Truck

CHROME VENT WINDOW FRAME

- Beautiful show ready triple chrome plated finish
- Mounting stud with threaded end for easy installation
- Sold in pairs

122641



1967-72 Chevy & GMC Truck

CHROME VENT WINDOW FRAME

- Beautiful show ready triple chrome plated finish
- Mounting stud with threaded end for easy installation
- Sold in pairs

122671

1967-72 Chevy & GMC Truck

LOWER GLASS CHANNEL

- High tensile strength steel like the original
- Sold individually, please specify LH/Driver or RH/Passenger

110244 | LH/Driver

110245 | RH/Passenger



OUTSIDE DOOR HANDLES



1947-51 Chevy & GMC Truck

OUTSIDE CHROME DOOR HANDLE SET

- Die-cast and chrome plated
- Pads and mounting screws included
- Sold in pairs

C475001



1952-59 Chevy & GMC Truck

OUTSIDE CHROME DOOR HANDLE SET

- Die-cast and chrome plated
- RH/Passenger handle includes push button, LH/Driver requires locking push button, sold separately
- Pads and mounting screws included
- Sold in pairs

110312



1960-66 Chevy & GMC Truck

OUTSIDE CHROME DOOR HANDLE SET

- Die-cast and chrome plated
- RH/Passenger handle includes push button, LH/Driver requires locking push button, sold separately
- Pads and mounting screws included
- Sold in pairs

110313



1967-72 Chevy & GMC Truck

OUTSIDE CHROME DOOR HANDLE SET

- Die-cast and chrome plated
- Pads and mounting screws included
- Sold in pairs

115670

INSIDE DOOR / WINDOW HANDLES



1947-66 Chevy Truck

INSIDE DOOR HANDLE

- Die-cast and chrome plated
- Sold individually

C476601



1967-72 Chevy Truck

INSIDE DOOR HANDLE

- Die-cast and chrome plated
- Sold individually

C677602



1967-72 Chevy Truck

DOOR HANDLE CLIP REMOVER TOOL

- Zinc plated stamped steel
- Removes inside door handle clips

C496404



1947-66 Chevy & GMC Truck

INSIDE WINDOW CRANK HANDLE

- Die-cast and chrome plated with black knob
- Sold individually

C476602



1967-72 Chevy Truck

INSIDE WINDOW CRANK HANDLE

- Die-cast and chrome plated with black knob
- Sold individually

C677601



Universal

BILLET ALUMINUM WINDOW CRANK HANDLE

- Classic aircraft style brushed aluminum finish
- Universal application, 3 adapters included (circular, splined & square)
- Includes stainless steel set screws & hex wrench

24039



1967-90 Chevy Truck

INSIDE WINDOW CRANK HANDLE

- Die-cast and chrome plated with clear knob
- Sold individually

C678101



Universal

BILLET ALUMINUM WINDOW CRANK HANDLE

- Classic aircraft style brushed aluminum finish
- Universal application, 3 adapters included (circular, splined & square)
- Includes stainless steel set screws & hex wrench

24009

WINDOW REGULATORS



116471



116512



116472



116552



116511



116602



116551



116642



116601



116672



116641



1947-71 Chevy & GMC Truck

WINDOW REGULATORS

- Durable steel stamping, counter balance spring included
- Zinc plated or painted black for corrosion protection
- Sold individually

- 116471 | 1947-50 | LH/Driver
- 116472 | 1947-50 | RH/Passenger
- 116511 | 1951-55 | LH/Driver
- 116512 | 1951-55 | RH/Passenger
- 116551 | 1955-59 | LH/Driver
- 116552 | 1955-59 | RH/Passenger
- 116601 | 1960-63 | LH/Driver
- 116602 | 1960-63 | RH/Passenger
- 116641 | 1964-66 | LH/Driver
- 116642 | 1964-66 | RH/Passenger
- 116671 | 1967-71 | LH/Driver
- 116672 | 1967-71 | RH/Passenger

DOOR SILL / DOOR LATCH RELAY



1967-72 Chevy & GMC Truck

CHROME DOOR SILL PLATE

- Fits LH/Driver or RH/Passenger
- Sold individually

C677201

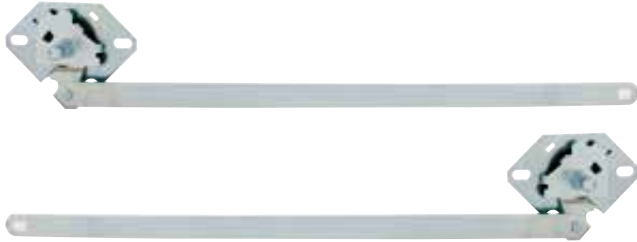

1947-55 Chevy & GMC 1st Series Truck

INSIDE DOOR LATCH RELAY

- Zinc plated steel
- Sold individually, please specify driver or RH/Passenger

110162 | RH/Passenger

110163 | LH/Driver



1947-55 Chevy & GMC 1st Series Truck

INSIDE DOOR LATCH RELAY

- Zinc plated steel
- Sold individually, please specify driver or RH/Passenger

C555902 | RH/Passenger

C555903 | LH/Driver



1960-63 Chevy & GMC Truck

INSIDE DOOR LATCH RELAY

- Zinc plated steel
- Sold in pairs

110164

110165

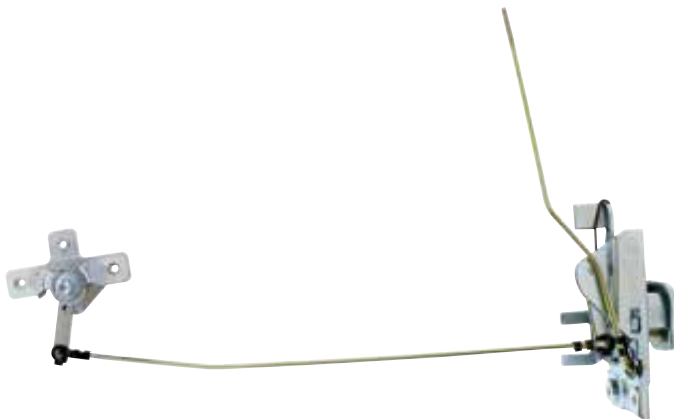

1964-66 Chevy & GMC Truck

INSIDE DOOR LATCH RELAY

- Zinc plated steel
- Sold in pairs

110166 | RH/Passenger

110167 | LH/Driver

1967-71 Chevy & GMC Truck

DOOR LATCH WITH REMOTE CONTROL RODS

- Zinc plated steel
- Sold individually, please specify driver or RH/Passenger

110246 | RH/Passenger

110247 | LH/Driver

DOOR LATCHES / STRIKER PLATES



1947-51 Chevy & GMC Truck

DOOR LATCH

- Zinc plated, precision stamping with original design mechanism
- Mounting hardware not included
- Sold individually

110186 | RH/Passenger

110187 | LH/Driver



1947-51 Chevy & GMC Truck

DOOR LATCH STRIKER PLATE

- Zinc plated, excellent reproduction of the original
- Mounting hardware not included
- Sold in pairs

110192



1952-55 Chevy & GMC Truck

DOOR LATCH

- Zinc plated, precision stamping with original design mechanism
- Mounting hardware not included
- Sold individually

110188 | RH/Passenger

110189 | LH/Driver



1960-63 Chevy & GMC Truck

DOOR LATCH

- Zinc plated, precision stamping with original design mechanism
- Mounting hardware not included
- Sold individually

110258 | RH/Passenger

110259 | LH/Driver

DOOR LATCHES / STRIKER PLATES



1955-59 Chevy & GMC 2nd Series Truck

DOOR LATCH

- Zinc plated, precision stamping with original design mechanism
- Mounting hardware not included
- Sold individually

110190 | RH/Passenger

110191 | LH/Driver



1952-59 Chevy & GMC Truck

DOOR LATCH STRIKER PLATE

- Zinc plated, excellent reproduction of the original
- Mounting hardware not included
- Sold in pairs

110193



1964-66 Chevy & GMC Truck

DOOR LATCH

- Zinc plated, excellent reproduction of the original
- Mounting hardware not included
- Sold in pairs

110260 | RH/Passenger

110261 | LH/Driver

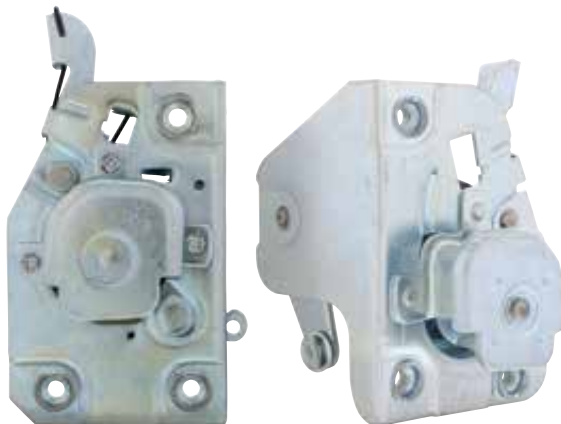

1967-72 Chevy & GMC

DOOR LATCH

- Zinc plated, precision stamping with original design mechanism
- Mounting hardware not included
- Sold individually

110262 | RH/Passenger

110263 | LH/Driver



1967-72 Chevy & GMC

DOOR LATCH STRIKER PLATE

- Zinc plated, excellent reproduction of the original
- Mounting hardware not included
- Sold in pairs

110223

RUNNING BOARDS / BEDSIDE STEPS

1947-54 Chevy & GMC Shortbed Truck

RUNNING BOARDS

- Black painted steel running boards
- Sold individually, please specify LH or RH side

170471 | LH/Driver

170472 | RH/Passenger



1947-54 Chevy & GMC Shortbed Truck

RUNNING BOARDS

- Chrome plated steel running boards
- Sold individually, please specify LH or RH side

170473 | LH/Driver

170474 | RH/Passenger



1955-59 Chevy & GMC Truck

SHORTBED BEDSIDE STEP

- Black painted steel running boards
- Sold individually, please specify LH or RH side

170551 | LH/Driver

170552 | RH/Passenger



1955-59 Chevy & GMC Truck

LONGBED BEDSIDE STEP

- Black painted steel running boards for trucks with 7 1/2 foot bed
- Sold individually, please specify LH or RH side

170553 | LH/Driver

170554 | RH/Passenger



HANGERS / HARDWARE

1960-66 Chevy & GMC Truck

BEDSIDE STEP HANGERS

- Die stamped with heavy 14 gauge steel, black EDP coated
- Features all the original frame to step mounting patterns
- Sold individually, please specify LH or RH side

110400 | RH/Passenger

110401 | LH/Driver



1967-72 Chevy Truck

CAB MOUNT KIT

- Quality molded rubber cab mounts
- 38 piece kit
- Includes all mounting bolts, lock nuts, spacers and larger washers

C677204

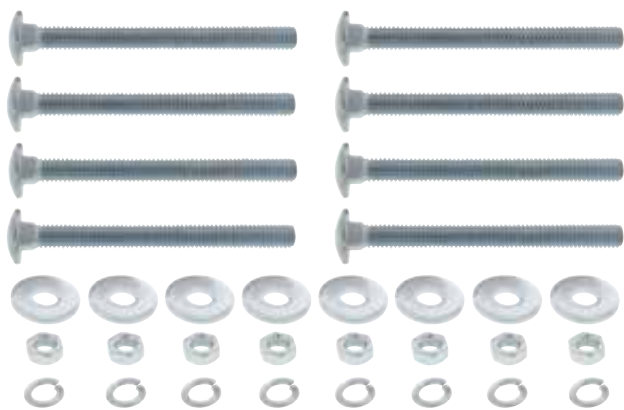

1967-72 Chevy & GMC Truck

PICKUP BED TO FRAME BOLT SET

- Special carriage bolts that mount the pickup bed to the frame
- Includes flat washers, lock washers, and hex nuts
- Zinc plated as original, sold as a set

110248



1941-53 Chevy & GMC Stepaside Truck

TAILGATE HINGES

- Sold in pairs

C415301 | Black

C415301C | Chrome

GAS CAPS



1938-71 GM Passenger Car and Truck

VENTED LOCKING GAS CAP

- High quality chrome plated gas cap
- Fits most early GM gas necks with 1.53" opening
- Integrated lock, two keys included
- For use only on vehicles originally equipped with vented gas cap

110319



1938-71 GM Passenger Car and Truck

GM LOCKING GAS CAP

- High quality chrome plated gas cap
- Fits most early GM gas necks with 1.53" opening
- Integrated lock, two keys included
- For use only on vehicles originally equipped with vented gas cap

110318



1947-71 Chevy & GMC Truck

CHROME LOCKING GAS CAP

- High quality chrome plated, vented gas cap
- Also fits 1958-63 Chevy car
- Integrated lock, two keys included

S1301



FUEL TANKS



1949-55 Chevy & GMC 1st Series Truck

18 GALLON TIN SHEET FUEL TANK

- Die stamped with Ni-Terne treated steel sheet metal
- Has all the original contour detail and mounting holes
- Machine welded for an even and complete seal

110687



1955-59 Chevy & GMC 2nd Series Truck

18 GALLON TIN SHEET FUEL TANK

- Die stamped with Ni-Terne treated steel sheet metal
- Has all the original contour detail and mounting holes
- Machine welded for an even and complete seal

110688



1967-72 Chevy & GMC C/K Series Truck

20 GALLON TIN SHEET FUEL TANK W/O EVAP

- Die stamped with Ni-Terne treated steel sheet metal
- Has all the original contour detail and mounting holes
- Machine welded for an even and complete seal
- For models without evap

110685



1970-72 Chevy & GMC C/K Series Truck

20 GALLON TIN SHEET FUEL TANK W/ EVAP

- Die stamped with Ni-Terne treated steel sheet metal
- Has all the original contour detail and mounting holes
- Machine welded for an even and complete seal
- For models with evap

110686



1973-81 Chevy & GMC C/K Series Truck

16 GALLON STEEL ZINC PLATED FUEL TANK

- Die stamped with Ni-Terne treated steel sheet metal
- Has all the original contour detail and mounting holes
- Machine welded for an even and complete seal

110683



1982-86 Chevy & GMC Shortbed Truck

16 GALLON STEEL ZINC PLATED FUEL TANK

- Die stamped with Ni-Terne treated steel sheet metal
- Has all the original contour detail and mounting holes
- Machine welded for an even and complete seal
- Sending unit available separately, item number: 110675, 110671, and 110673

110684

FUEL SENDING UNITS



1973-75 Chevy & GMC Truck

FUEL SENDING UNIT TANK - RH

- Made with corrosion resistant stainless steel sheet metal
- Features a single outlet only design with brass float just like the original
- Rubber seal, stainless steel lock ring, and strainer included

110676



1973-79 Chevy & GMC Truck

FUEL SENDING UNIT TANK - LH

- Made with corrosion resistant stainless steel sheet metal
- Features a 2 outlet design with brass float just like the original
- Rubber seal, stainless steel lock ring, and strainer included

110674



1973-79 Chevy & GMC 6 Cylinder Truck

FUEL SENDING UNIT TANK - RH

- Made with corrosion resistant stainless steel sheet metal
- Features a single outlet only design with brass float just like the original
- Rubber seal, stainless steel lock ring, and strainer included

110672



1973-79 Chevy & GMC Truck

FUEL SENDING UNIT TANK - RH

- Made with corrosion resistant stainless steel sheet metal
- Features a 2 outlet design with brass float just like the original
- Rubber seal, stainless steel lock ring, and strainer included

110670

FUEL SENDING UNITS



1980-84 Chevy & GMC Truck

FUEL SENDING UNIT TANK - LH

- Made with corrosion resistant stainless steel sheet metal
- Features a 2 outlet design with brass float just like the original
- Rubber seal, stainless steel lock ring, and strainer included

110673



1980-89 Chevy & GMC Truck

FUEL SENDING UNIT TANK - LH

- Made with corrosion resistant stainless steel sheet metal
- Features a 3 outlet design with brass float just like the original
- Rubber seal, stainless steel lock ring, and strainer included

110675



1980-89 Chevy & GMC Truck

FUEL SENDING UNIT TANK - RH

- Made with corrosion resistant stainless steel sheet metal
- Features a 3 outlet design with brass float just like the original
- Rubber seal, stainless steel lock ring, and strainer included

110671

EMBLEM

CHEVROLET

1967-68 Chevy & GMC Truck

CHROME HOOD LETTER EMBLEM SET

- Beautiful chrome plated die-cast
- Identical mounting stud location as original for easy replacement
- Speed nuts included
- OEM GM # 3892085, GM restoration licensed product

110057



HUB CAPS / EXHAUST DEFLECTORS



1947-53 Chevy 1/2 Ton Truck

CHROME HUBCAP

- Chrome hub cap with red Chevrolet script
- GM restoration parts, sold individually

C475303 | Stainless Steel

C475304 | Chrome



1968-70 Chevy Truck & Car

SS BULLET CENTER STYLE RALLY HUB CAP

- Set of 4 highly polished stainless steel
- Fits original rally wheels and aftermarket rally wheels

C687003



Universal

SMOOTH STAINLESS STEEL BEAUTY RIM

- Highly polished stainless steel, smooth plain style
- Round notch for valve stem clearance, sold individually

A6224-3 | 14" Beauty Rim

A6224-1 | 15" Beauty Rim

A6224-2 | 16" Beauty Rim



Universal

RIBBED STAINLESS STEEL BEAUTY RIM

- Highly polished stainless steel, smooth plain style
- Round notch for valve stem clearance, sold individually

A6224-4 | 14" Beauty Rim

A6224-5 | 15" Beauty Rim

A6224-6 | 16" Beauty Rim



Chevy & GMC Truck

EXHAUST DEFLECTOR

- 304 high grade stainless steel, rust free
- Fits most exhaust pipes, GM restoration parts

C2002 | With "Chevrolet" Script Bowtie

C2003 | With Bowtie



LICENSE PLATE FRAMES



1947-60 Chevy

CHROME LICENSE PLATE FRAMES

- Chrome zinc die-cast frame with white script and year on dark blue background
- GM restoration parts

C5041-47 1947	C5041-54 1954
C5041-48 1948	C5041-55 1955
C5041-49 1949	C5041-56 1956
C5041-50 1950	C5041-57 1957
C5041-52 1952	C5041-59 1959
C5041-53 1953	C5041-60 1960

LICENSE PLATE FRAMES



1962-72 Chevy

CHROME LICENSE PLATE FRAMES

- Chrome zinc die-cast frame with white script and year on dark blue background
- GM restoration parts

C5041-62 1962	C5041-68 1968
C5041-63 1963	C5041-69 1969
C5041-65 1965	C5041-70 1970
C5041-66 1966	C5041-71 1971
C5041-67 1967	C5041-72 1972

HORNS



46127



46129



46130

Universal

ECONOMY TRAIN HORN

• Economy 3 & 4 trumpet air horns

46127 | Black 3 Trumpet

46129 | Chrome 3 Trumpet

46130 | Chrome 4 Trumpet



46107



46108

Universal

TRAIN WHISTLE

• Simulates the sound of a vintage train whistle

• Mounting hardware and 1/2" compression fitting included

• Powered by compressed air or live steam

• Operating range from 30 PSI to 120 PSI and up

• 5 1/2" L x 5" W x 13 1/8" H

46107 | Chrome

46108 | Brass



Universal

CHROME MINI TRAIN HORN

• Deluxe chrome 4 trumpet mini train horn

• Easy installation, approximate size: 6 1/2" x 12" x 6"

46123



Universal

CHROME DELUXE 4 TRUMPET TRAIN HORN

• Low rider style

• 150 + -10db sound output

• Width 15 3/4", length 15 1/4", height 9 3/4"

46143

HORNS / AIR COMPRESSOR



Universal

HIGH POWER DIXIE AIR HORN

- Air horn that imitates the howl of a wolf
- Hardware included

46153



Universal

RED ELECTRIC BULL HORN

- Air horn that imitates the sound of an angry bull
- Painted red housing, 12V systems

46103



Universal

ELECTRIC AH-OO-GAH HORN

- Chrome body, 12V systems
- -110 dB (A) sound pressure level, 490 Hz frequency

46138



Universal

WOLF SOUND HORN

- Air horn that imitates the howl of a wolf
- Hardware included

46128



Universal

TURBO COMPRESSOR AND TANK KIT

- Heavy duty compressor and tank system for high pressure air/train horns
- High volume turbo compressor with 5.5 liter extended tank
- On-board air system for all 12 volt vehicles

46140

TERMS & CONDITIONS / ORDERING GUIDELINES / FREIGHT

IMPORTANT: PLEASE REVIEW CAREFULLY

New Accounts

Initial minimum buy-in is \$2,000 (or to be determined by United Pacific Industries, UPI hereafter). All initial orders must be prepaid in advance by Cashier's Check or VISA/MC. All new/potential accounts must complete a UPI "New Customer Info/Credit Form" and follow the Dealer Qualification Instructions. Upon completion of the credit application, approved accounts will be assigned payment terms of NET 30 Days (from invoice date). Accounts denied a credit line will be required to prepay in advance by Cashier's Check or VISA/MC.

Payment Terms:

Term Accounts

Accounts with NET 30 Days terms are required to submit payment within the 30 days from the date of invoice. Acceptable forms of payment include checks, ACH (Automated Clearing House), or wire transfer.

A service charge of 1.5% per month will be imposed on invoices not paid within the 30 day term. Delinquent accounts will be required to pay Cash-In- Advance (CIA). Checks will be accepted but orders will not be released until the check is cleared by the bank. Past due invoices will delay current orders. Please check with UPI on your account status when placing an order.

Credit Cards

Accounts denied credit terms may pay by Visa or MasterCard. Credit card will be charged upon shipment. Credit card payments will not be accepted once an order has been shipped. UPI does not accept American Express or Discover card.

COD

A \$9.00 fee will be assessed per COD box for all FedEx/UPS COD shipments. Truck COD shipment fees are to be determined later by trucking company.

Returned Checks:

A \$30 NSF (Non Sufficient Fund) fee will be assessed on each incidence a check is returned to UPI.

ORDERING GUIDELINES

Placing Orders: New orders may be placed by any of the following methods

1. Fax: **888.986.6088**
2. E-mail: antique@upauto.com
3. Telephone: In order to minimize errors, customers are encouraged to submit their orders by fax or email. Telephone orders should be limited to smaller orders such as add-ons to orders already submitted and/or fill-ins occurring between larger restocking orders.

Changes to Orders:

Whenever possible, revisions to orders - additions or deletions of items - should also be submitted via fax or email to reduce the possibility of errors.

Additions/Deletion of items will only be accepted within 48 hours after the initial order date and/or before 12:00PM on the date of the shipment. Additions of items placed after the 48 hours time period will be considered a new order and adhere to a new order freight prepaid policy. Deletions of item cannot happen after the 48 hours time period and/or after 12:00PM on the date of the shipment. Please note additions and/or deletions of items will delay the shipment date.

Canceling Orders:

Cancellation of orders must be submitted via fax or email within 24 hours of the order date. If the order has already shipped it will be the customers responsibility to return the order at the customers own expense. A restocking fee may apply, please see "Return" policy for further detail.

Backorders:

Customers have the option of having their backorders shipped or canceled. UPI will notify customer as to availability of backorders and will be able to ship any backorder items customer still needs as part of their next stock order. UPI reserves the right to cancel backorders that are 6 months or older from the initial invoice date.

Minimum Order:

A minimum order of \$50.00 is required. Orders below \$50.00 will be assessed a minimum order fee of \$10.00.

Packaging:

A 10% service charge will be added to orders with special packaging or UPC barcoding requirements.

Lead Times:

Standard lead time for all United Pacific orders is 1-3 business days from the receipt of the purchase order. Larger orders may require a lead time of up to 5 business days. Transit time of 3-5 business days must be considered when placing orders. UPI cannot be responsible for delays in shipment after an order leaves our warehouse. UPI will work to resolve delays with freight forwarding firms, however, delays do arise from time to time due to weather and unforeseen circumstances beyond UPI's control. Express order are exempted; please view Freight/Shipping Policy for further detail.

Order Confirmation:

United Pacific will acknowledge receipt of orders by email/fax/ telephone within 1 business day of receipt. If confirmation is not received, please contact UPI to ensure your order was received.

FREIGHT

Prepaid Freight:

Stock orders between \$50 and \$999.99 (US Lower 48 States), **\$50 and \$2499.99 (Alaska and Hawaii)**, **\$50 and \$1499.99 (Canada)**, [all price net US\$], will be shipped FOB Long Beach, California. Stock orders of \$1,000 (US Lower 48 States), **\$2500 (Alaska and Hawaii)**, **\$1500 (Canada)**, [based on UPI current pricing], or more will be shipped Freight Prepaid Ground to a single location only. (See exception for Oversize Items*). Express Air orders, Special Net Pricing orders, and Special Quote Pricing orders are excluded. United Pacific reserves the right to select the carrier of our choice. Customers may select the carrier of their choice at their own expense, negotiated rates and insurance. If customers elect to choose their own freight carrier, orders will be shipped via FREIGHT COLLECT.

Oversize Item Freight Policy – Applies to 1932 Ford car & truck body shell assemblies, 1932 Ford car & truck body parts such as floor assembly, roof, door, fender, quarter panel, grille, bulk rail gutter, bulk roof tack strip, chassis & frame, wheels & tire, and any exceptionally large or heavy item.

1. Freight will be prepaid by United Pacific if the total order of all items exceeds \$4,000 (US Lower 48 States) or **\$5000 (Hawaii, Alaska and Canada)**, [all price net US\$]. There will not be additional charges for these items included on the order.
2. Freight will be prepaid by United Pacific if a customer orders a total of \$2,500 (US Lower 48 States) or **\$3500 (Hawaii, Alaska and Canada)**, [all price net US\$], of PB 379 fenders, 60" or longer exhaust, and/or 18"+ Longer Saddle Boxes only. If the order is below \$2,500 (US Lower 48 States) or **\$3500 (Hawaii, Alaska and Canada)**, United Pacific will add freight charges to the order for the oversize items.

Will Call Orders:

Will Call orders can be picked up 2 - 4 hours after placing the order. Customers should always call ahead to confirm when order will be ready to pick up.

SHIPPING POLICY / CLAIMS

IMPORTANT: PLEASE REVIEW CAREFULLY

SHIPPING POLICY

International Shipments:

Shipments to locations outside the continental United States will be shipped to the customer's shipping agent or broker within the continental United States in accordance with the US freight policy. International customers will be responsible for the duties and taxes of their respective country.

Express Orders:

All express orders, such as Next Day, Second Day, 3 Day Service & Will Call, must be faxed/mailed. Order confirmation will be faxed to the customer for final approval. If confirmation is not received, please contact UPI to ensure your order was received. Customers are required to sign off on express orders and fax confirmation back to UPI. Cut off for express order is 12:00PM. Express orders received after 12:00PM may or may not ship the same day. Please call UPI to confirm projected shipping date or will call time.

Due to the high cost of express shipments, customer may request UPI to call to confirm freight charges. If customer does not request confirmation, UPI will ship the express order.

Drop Shipments:

All drop shipment orders will be assessed a 5% processing fee. Drop shipment processing fee will be automatically added to the invoice without notice. All drop shipment orders must be faxed in. No freight allowance or prepaid freight will be permitted for any drop shipments, thus, all drop ship orders, regardless of order size, are FOB Long Beach, CA.

CLAIMS

General Policy:

All claims (Shortage, Mis-Shipped, Damage, Overage, Customer Error & Billing Error) must be submitted to UPI within 3 business days of the receipt of shipment. Claims submitted beyond 3 business days of the receipt of shipment will be voided by UPI.

On all shipments, the person who signs and receives the shipment is responsible for noting on the Bill of Lading, in writing, whether any boxes arrived damaged or shorted. Failure to do so will void all claim rights between all parties. UPI will have no recourse against the trucking company if customer does not note any damages or shortages on the Bill of Lading.

The customers receiving department must count and sign for the exact number of boxes received. Failure to follow the above instructions will void all claim rights between all parties.

Shortages / Mis-Ships / Damages

While UPI strives to fill every order with 100% accuracy, on occasion an item may get shipped in error or get damaged during shipping. In the event this occurs, please follow the process below. Note: This type of claim must be reported to UPI within three (3) business days of receiving the order.

1. Contact the United Pacific office to initiate the claim. To make it easy for you we have two acceptable methods for requesting the claim:

- By e-mail : returns@upauto.com
- By fax : [888.986.6088](tel:888.986.6088)

* **Note: To ensure you receive a timely credit, we cannot accept claim requests by phone.**

2. You will be required to provide the following information:

- Your business name
- Contact name and telephone number (in case we have questions)
- Date the order was received
- A copy of the Packing List / Invoice noting the item number and quantity that was shipped in error or damaged during shipping.
- Special instructions you have for us.

3. UPI will send a return label so you can ship the items back.

4. Once we receive the miss-shipped/damaged item(s) a credit will be issued to your account on the next billing cycle.

5. Shortages will be credit to the Customers' account, unless customer would like the shortages replaced.

Overages:

UPI strives to provide our customers with the best customer service and products, in turn we would greatly appreciate any help from customer in notifying UPI of any shipping overages. Customers will be offered the option of retaining the merchandise or returning the merchandise to UPI at UPI's expense. If the items are to be returned, an RMA number and return shipping label will be provided.

Customer Errors:

Any item or quantity ordered in error by the customer may be returned by contacting UPI for a RMA No.

1. To make it easy for you we have two acceptable methods for requesting the RMA:

- By e-mail: returns@upauto.com
- By fax: [888.986.5988](tel:888.986.5988)

* **Note: To ensure you receive a timely RMA credit, we cannot accept RMA requests by phone.**

2. You will be required to provide the following information.

- * Your business name
- * Contact name and telephone number (in case we have questions)
- * A list of the items number and quantity ordered in error
- * Special instructions you have for us

3. UPI will review the request to ensure the products are within the return period.

4. Once we have validated the request, United Pacific will issue an RMA number to the customer. In issuing the RMA approval, the following conditions will apply :

- Returned items are subject to a 20% re-stocking fee.
- Return shipping costs are the responsibility of the customer.
- Items must not have any retail/price sticker on exterior packaging or they will be returned to the customer at customer's expense and no credit given.
- Items must be in good condition with original packaging intact or they will be returned to the customer at customer's expense and no credit given.
- Allow up to 30 days for the credit to be issued from the time the returned items are received.

Billing Errors:

Billing errors should be reported to UPI within 3 business days of invoice receipt. Customers are asked to provide the invoice number, part number, and quantities in question. Once verified, UPI will issue a credit or an invoice for the difference in billing error.

WARRANTY POLICY / RETURNS

IMPORTANT: PLEASE REVIEW CAREFULLY

WARRANTY POLICY

General Policy:

UPI offers a NO HASSLE WARRANTY RETURN policy to all our customers. Warranty claims can only be submitted through an authorized UPI Distributor. UPI warranty is not transferable and applies to the original installation and purchase only. In no event shall UPI be liable for incidental or consequential damages, nor shall UPI be liable for any claims or damages arising out of or connected with the UPI warranty exceed the purchase price of the products. There are no warranties, expressed or implied (including any warranty of merchantability or fitness) that extend beyond this warranty. The warranty does not apply to costs associated with the loss of use of the product, loss of time, inconvenience, commercial loss, incidental or consequential damages. UPI reserves the right to alter the designs of products without assuming any obligation to modify previously manufactured products and will only replace warranted products with redesigned products.

Warranty does not apply to merchandise that has been drilled, cut, welded, modified in any way or installed contrary to normal installation and usage. In addition, UPI cannot be held liable for damages caused by road hazards, accidents, misuse, neglect, abuse or corrosive environments including acid washes and highway snow/ice chemicals which can cause discoloration and corrosion in aluminum, chrome, stainless steel and light products. UPI reserves the right to credit returned merchandise at the initial purchase price or at the current selling price, which price ever is lower.

Aluminum / Chrome / Stainless Steel Products:

All aluminum, chrome, and stainless steel products carry a limited 6 month warranty (from invoice date) against defects in material or workmanship.

Lighting Products:

Incandescent

All incandescent lighting products carry a limited 12 month warranty (from invoice date) against defects in material or workmanship. The limited 12 month warranty does not apply to several applications, such as, buses, construction equipment, and off road vehicles.

LED

All LED lighting products carry a specific Limited Warranty (from invoice date) against defects in material or workmanship.

- LED with vehicle specific application is limited lifetime warranty to an original purchaser with receipt. Examples of lifetime warranty product: CTL5720LED CTL5720LED for 1957 Chevy, FTL3201LED-L for 1932 Ford.
- LED Marker, 2", 2-1/2", 4", 7", Oval & Square Lights - Varies from 2 years to 10 years to Limited Lifetime, depending on specific item. The housing, bezel or mounting base on any light made from Chrome/Stainless carries a 6 month limited warranty.
- LED Cab Lights and Kits, Double/Single Stud Turn Signal and PB/KW/FL/VL or non-make Turn Signals and any/all Strip Lights - Varies from 2 years to 10 years to Limited Lifetime, depending on specific item. The housing, bezel or mounting base on any light made from Chrome/Stainless carries a 6 month limited warranty.
- LED Beacon, Driving, Headlights, Work & Warning Lights - Varies from 6 months to 3 years. The housing, bezel or mounting base on any light made from Chrome/Stainless carries a 6 month limited warranty.
- All LED Accessory Lights (Honda, Stainless Steel Double/Single face Lights, Interior Lights, License Plate Lights, and any Accent Lights. The housing, bezel or mounting base on any light made from Chrome/Stainless carries a 6 month limited warranty.

RETURNS

General Policy:

All returns must be authorized by UPI. All return requests must be faxed or e-mailed (returns@upauto.com) A RMA number (Return Merchandise Authorization Number) will be provided. Returns not possessing a valid RMA number are subject to rejection and will be returned to sender at the customer's expense.

All customers are encouraged to use the Warranty RMA Claim Form.

Defective Goods / Warranty Return:

UPI offers our customers a No Hassle Warranty Return. Please follow the instructions below for requesting a RMA for defective goods:

1. If any warranty issues occur, simply contact the UPI for RMA number To make it easy for you we have two acceptable methods for requesting the RMA:
 - By e-mail: returns@upauto.com
 - By fax: **888.986.5988**
 - **Note: To ensure you receive a timely RMA credit, we cannot accept RMA requests by phone.**
2. You will be required to provide the following information:
 - Your business name
 - Contact name and telephone number (in case we have questions)
 - A list of the defective item number and quantity with the nature/ reason of the defect
 - Special instructions you have for us
 - The enclosed fax form may be used for your convenience to request an RMA
3. UPI will review the request to ensure the products are within the stated warranty period.
4. Once we have validated the warranty items, a RMA confirmation, listing the items and cost will be faxed to the customer within 3 business days. UPI will process the credit to your account within 30 days.

Note: There will be no need to return the warranty product to us. However, from time to time, UPI may require some warranty products to be shipped back so we may analyze the cause of the failure. All warranty products that are required to be shipped back will be freight prepaid by UPI.

Stock Return

United Pacific Industries encourages all customers to regularly monitor the sales volume and stock level of their inventory items. As sales trends may slow the movement of specific items, our hope is that those items are featured as "close-out specials" as to minimize stock returns. We also understand that the customer, from time to time, may accumulate over-stock items and desire to return those. Therefore, we have adopted the following policy below.

NOTE:

- Items must have been purchased by the dealer requesting the stock return.
 - Items must have been purchased within the preceding 12 months.
 - Items that have been discontinued will not be considered for return.
1. Contact the United Pacific office for RMA number We have 2 acceptable methods for requesting the RMA:
 - By e-mail : returns@upauto.com
 - By fax : **888.986.6088**
 - *Note: To ensure you receive a timely RMA credit, we cannot accept RMA requests by phone.**

PRODUCT INDEX

ITEM #	PAGE #	ITEM #	PAGE #	ITEM #	PAGE #	ITEM #	PAGE #
10444	30	31374	23	70679	90	110191	104
10445	30	31375	21	70801	81	110192	103
10448	30	31376	21	70802	82	110193	104
10449	30	31378	15	70803	81	110199	40
10461	30	31379	15	70804	82	110200	46
10466	30	31386	17	88300	94	110201	46
10467	29	31387	16	88301	94	110202	46
10468	29	31388	24	88302	94	110213	42
10476	30	31389	24	88304	94	110214	42
10477	30	31390	24	105471	61	110215	45
10532	29	31391	12	105551	61	110216	46
21476	30	31393	16	105601	61	110217	58
21477	30	31396	22	105631	61	110223	104
23525	90	31397	22	105671	61	110243	80
23529	90	31458	11	105672	61	110244	98
24009	100	31459	12	105711	61	110245	98
24039	100	31496	14	106471	62	110246	102
30354	16	31513	13	106542	62	110247	102
30356	16	31514	13	106552	62	110248	106
31084	14	34122	18	106581	62	110249	68
31087	18	34125	22	106631	62	110250	68
31088	20	34222	25	106671	62	110252	89
31089	20	34263	25	106672	62	110258	103
31150	19	34264	25	110017	86	110259	103
31151	19	36888	25	110018	86	110260	104
31152	19	39006	40	110019	86	110261	104
31153	19	39014	40	110020	86	110262	104
31168	21	39043	56	110049	91	110263	104
31169	21	39065	58	110050	91	110264	91
31200	13	39132	25	110051	91	110279	67
31201	17	40028	92	110052	91	110280	68
31202	17	46103	116	110057	111	110281	68
31237	21	46107	115	110110	33	110282	28
31238	21	46108	115	110111	33	110283	28
31247	15	46123	115	110114	43	110289	90
31259	17	46127	115	110115	43	110300	79
31267	17	46128	116	110127	58	110301	79
31274	22	46129	115	110162	102	110302	79
31275	22	46130	115	110163	102	110303	79
31284	15	46138	116	110164	102	110304	79
31285	15	46140	116	110165	102	110305	79
31289	12	46143	115	110166	102	110306	79
31297	18	46153	116	110167	102	110307	89
31299	20	60039	76	110168	58	110312	99
31355	14	60050	76	110186	103	110313	99
31365	19	70300	59	110187	103	110314	92
31368	23	70301	59	110188	103	110317	91
31369	23	70302	59	110189	103	110318	107
31372	26	70303	59	110190	104	110319	107
31373	23	70677	90			110338	95

PRODUCT INDEX

ITEM #	PAGE #
110339	67
110340	67
110341	67
110342	67
110344	68
110345	68
110358	28
110362	46
110387	66
110388	66
110389	66
110390	66
110400	106
110401	106
110402	95
110403	92
110404	38
110405	38
110415	32
110416	32
110419	32
110420	32
110429	27
110446	58
110470	69
110471	69
110472	69
110473	69
110582	96
110670	109
110671	110
110672	109
110673	110
110674	109
110675	110
110676	109
110683	108
110684	108
110685	108
110686	108
110687	108
110688	108
110700	87
110701	87
110705	27
110718	63
110719	63
110720	63
110721	63
110722	63

ITEM #	PAGE #
110724	64
110725	64
110726	64
110728	63
110729	63
110730	64
110731	64
110733	64
110741	74
110742	74
110743	74
110748	73
110748	73
110749	72
110750	34
110765	35
110766	35
110767	35
110768	35
110770	60
110771	60
110794	94
110795	39
110807	69
110829	9
110830	9
110839	10
110845	10
110846	10
110847	10
115670	99
116471	101
116472	101
116511	101
116512	101
116551	101
116552	101
116601	101
116602	101
116641	101
116642	101
116671	101
116672	101
120511	97
120512	97
120513	97
120514	97
120641	97
120642	97
120643	97

ITEM #	PAGE #
120644	97
120671	97
120672	97
120673	97
120674	97
122511	98
122601	98
122641	98
122671	98
170471	105
170472	105
170473	105
170474	105
170551	105
170552	105
170553	105
170554	105
190471	80
190472	80
190541	80
190542	80
190601	80
190602	80
190671	80
106601W	62
106601WO	62
34217B	25
39994B	59
5007R	89
A5007	89
A5023-3	16
A6224-1	112
A6224-2	112
A6224-3	112
A6224-4	112
A6224-5	112
A6224-6	112
A6235	79
A6236	79
A7026	79
A7027	79
A7037	79
C2001A	30
C2001B	30
C2001G	30
C2001R	30
C2002	112
C2003	112
C383901	61
C4008-1	44

ITEM #	PAGE #
C4008-2	44
C4009	34
C4009-1	34
C415301	106
C415301C	106
C475001	99
C475301	88
C475302	88
C475303	112
C475304	112
C475307	53
C475307CR	53
C475308	54
C475309C	87
C475309M	87
C475310	84
C475310CR	83
C475313	66
C475321	87
C475351	84
C475501	70
C475502	89
C475510	78
C475511	78
C475512	78
C475513	78
C475901	89
C475902	83
C476601	100
C476602	100
C476901	77
C476902	77
C476903B	77
C476904	77
C477201	77
C477202	77
C477203	86
C477203	88
C477204	62
C496404	100
C5001	74
C5001-1	74
C5001-1CVX	74
C5001-CVXLED	74
C5001-LED	74
C5006	30
C5010	30
C5025	58
C5026	58
C5041-47	113

PRODUCT INDEX

ITEM #	PAGE #
C5041-48	113
C5041-49	113
C5041-50	113
C5041-52	113
C5041-53	113
C5041-62	114
C5041-63	114
C5041-65	114
C5041-66	114
C5041-67	114
C515301	51
C515301	54
C515321	54
C535910CR	83
C545502BK	45
C545502CR	45
C545502SS	45
C545503BK	45
C545503CR	45
C545503SS	45
C545504-2	44
C545504BK	36
C545504SS	36
C545505	36
C545506	44
C545507	36
C545521	87
C555711	70
C555751A	51
C555751C	51
C555755	54
C555901	58
C555902	102
C555903	102
C555904	88
C555905	88
C555908	37
C555909	44
C555910	36
C555911	36
C555911-3	44
C555912	37
C555921	87
C555931	87
C555941	78
C555942	78
C555943	78
C555944	78
C556601BK	45
C556601CR	45

ITEM #	PAGE #
C556601SS	45
C556602BK	45
C556602CR	45
C556602SS	45
C585901	37
C585902	37
C585902ALU	44
C585902SS	44
C585911	70
C585981	27
C60609C	40
C606321	87
C606331	87
C606603	40
C606603	44
C606604	70
C606605	37
C606607	36
C606608	36
C606609	40
C606610	37
C606611	40
C606612	54
C606614	45
C606615	45
C606616	39
C606616BD	39
C606616C	39
C606617	40
C606618	40
C606621	52
C606651	45
C607110	84
C607111	84
C607112	84
C626601	53
C646621	87
C646631	87
C676802	95
C676811A	52
C676811C	52
C676812	54
C676851	92
C677201	102
C677203	70
C677204	106
C677207	45
C677209	42
C677210	95
C677211	95

ITEM #	PAGE #
C677212	70
C677214	96
C677215	96
C677216	96
C677217	96
C677218	96
C677251	92
C677601	100
C677602	100
C678101	100
C679101	56
C687003	112
C687202	56
C687203	56
C697020	52
C697021	52
C7001G	59
C7001L	33
C7001L-1	33
C7001R	33
C7001R-1	33
C7002R	33
C7003L	45
C7003R	45
C7004L	45
C7004R	45
C7006	38
C7006-1	38
C7007	46
C7008	38
C7008-1	38
C7009A	51
C7009C	51
C7010	51
C7011	27
C7011-KIT	27
C7012	27
C7013	27
C7014A	51
C7014C	51
C7018	95
C7019	51
C7021	59
C7026LSS	45
C7026RSS	45
C7028L	33
C7028L-1	33
C7028R	33
C7028R-1	33
C7031RL	33

PRODUCT INDEX

ITEM #	PAGE #	ITEM #	PAGE #
C7031RLBD	32	CTL4053LED-R	34
C7031RR	33	CTL4053LED-RBD	34
C7031RRBD	32	CTL4053LL	59
C7032RLBD	32	CTL5459BC	35
C7033RL	33	CTL5459BR	35
C7033RLBD	32	CTL5459C	37
C7033RR	33	CTL5459LED	37
C7033RRBD	32	CTL5459SC	35
C707201	73	CTL5459SR	35
C707201	73	CTL5859C	37
C707201-LED	72	CTL5859LED	37
C707202	73	CTL6066BC	36
C707202	73	CTL6066BR	36
C707202-LED	72	CTL6066C	37
C717201	54	CTL6066FC	40
C717221	52	CTL6066FSC	39
C738001	56	CTL6066FSLED	40
C738002	56	CTL6066FSR	39
C738003	56	CTL6066LED	37
C738011	70	CTL6066SC	36
C738703	46	CTL6066SR	36
C738704	43	CTL6721C	41
C738705	43	CTL6721LED	41
C738710	73	CTL6721SEQ	41
C738710-CVXLED	72	CTL6722CL	38
C738710-LED	72	CTL6772C	38
CML6872A	56	CTL6772LED	38
CML6872R	56	CTL7387LED-L	43
CML7380A	56	CTL7387LED-R	43
CML7380R	56	H5006	17
CPL4753A	50	M1003	81
CPL4753A-AS	50	S1201	90
CPL4753C	50	S1202	90
CPL4753C-AS	50	S1204	89
CPL5153C	50	S1301	107
CPL5557A	50		
CPL5557C	50		
CPL6066A	48		
CPL6768A	48		
CPL6768C	48		
CPL6970AL	49		
CPL6970AR	49		
CPL6970CL	49		
CPL6970CR	49		
CPL7172A	48		
CPL7172C	48		
CTL4053LED-CL	34		
CTL4053LED-CR	34		
CTL4053LED-L	34		
CTL4053LED-LBD	34		



United Pacific

UPauto.com | T 866.327.5288 | F 888.986.6088

© 2019 United Pacific Industries. All Rights Reserved.
Products not shown to scale. Specifications subject to change without notice.

ACPU01
1947-87 CHEVY & GMC TRUCKS
CATALOG



710270059478