



United Pacific

# LED LIGHTING

CLASSIC CAR & TRUCK





# United Pacific

## HOW TO ORDER

To order from United Pacific Industries, you must be an authorized dealer, distributor or OEM.  
If you are not authorized to stock and sell United Pacific products, you must order through an authorized dealer.  
Please call 866.327.5288 for more information.

## CONTACT US

 8 am - 4:30 pm PST

 866.327.5288 / 562.425.5588

 888.986.6088 / 562.425.3632

 [Antique@upauto.com](mailto:Antique@upauto.com)

 [UPauto.com/classic](http://UPauto.com/classic)

 3788 E. Conant St., Long Beach, CA 90808



## QUALITY

With over 30 years of experience in the automotive aftermarket industry, United Pacific Industries understands the rigors and stresses that our products are subjected to on the road. It is our mission to provide our customers with products of superior quality and reliability. In achieving this goal, United Pacific only partners with manufacturing facilities that conforms to our quality control requirements and standards. Our manufacturing partners meet or exceed ISO-9001 requirements. In addition, United Pacific's manufacturing partners must be equipped on site to perform the following quality assurance tests and maintain a track record of consistent quality and low product failure rate.

- Aging Test
- Air Tight Test
- Dust Test
- Flux Test
- Photometric Test
- Pull Force Test
- Rain Test
- Salt Spray Test
- Shock Test
- Temperature Test
- Humidity Test
- Vibration Test

Furthermore, our internal quality control structure allows us to function as the final quality control station prior to shipping. With the assistance of 3D computer technology, United Pacific can adhere to strict quality control standards during prototype creation and the production process. Our engineers and technicians perform a battery of tests to ensure that our products meet the demands of today's drivers and our goal to be first in quality.

## INNOVATION

Known as the leader in innovation, United Pacific is dedicated to be the first to bring new and exciting products to the market. United Pacific's global expertise allows us to search the globe for new ideas and concepts. Not only do we search the globe for new products, United Pacific invest a significant amount of resources into our own research and development efforts. With the assistance of advance 3D scanning technology, our engineers and designers can acquire accurate and precise data in seconds.

The 3D data allows United Pacific to verify designs, perform quality assurance tests, and reverse engineer with unprecedented speed and accuracy. Digital inspection contributes to the early detection of shape problems, provides rapid feedback on design, and eliminates unnecessary work in downstream processes. Our rapid prototyping facility permits us to have a concept-to-shelf time of less than 5 months. In addition, United Pacific's 3D printing capabilities permit our designers to have physical models of their design concepts in hours. The physical models allow our designers and marketing staff to evaluate and test the viability of different design ideas. Our rapid prototyping facility allow United Pacific to compress design cycles, improve manufacturing planning, shorten concept-to-shelf time, most importantly, generate new and innovative products.

## DESIGN

Located near some of the nation's most progressive automotive design centers, United Pacific established the UP Design Studio in 2002 to consolidate our position as the design leader in the automotive industry. UP Design Studio utilizes the latest generation of computer aided design (CAD) and studio/graphic software. The design studio is equipped with the newest computers and rapid prototyping systems. In addition, UP Design Studio is staffed by graduates from the nation's most prestigious design colleges. Unlike our competitors, United Pacific's design and manufacturing capabilities mean that we carry more new and original items than our competitors. The establishment of the design studio will enable us to generate even more new products with significant shorter concept-to-shelf time. The reduction in development cost mean that we can develop products utilizing design based development processes. Design based product development allows United Pacific to create new product concepts based on designs incorporating driver demands and needs instead of economic considerations. United Pacific's emphasis on design distinguishes and positions us ahead of our competitors.



## WARRANTY

With LED (Light Emitting Diodes) rated at 100,000 hours of operation and solid-state construction, United Pacific's LED lights are extremely reliable and durable. Purchase with confidence, United Pacific offers a complete line of LED lighting products with extended or limited lifetime warranties. Please see the warranty policy page for more details.

## INVENTORY AND SHIPPING

United Pacific carries over 20,000 items in our California distribution center. No other company in the heavy duty trucking industry can match United Pacific in the variety and range of in-stock inventories. With an order fill rate of over 98.5%, United Pacific is the largest and most reliable supplier in the industry. Our shipping department ships 96.8% of all orders within 24 hours and 98.9% within 48 hours. United Pacific's vast inventory and prompt shipping has made United Pacific the only source for our customer's chrome and lighting needs.



HARD AT WORK FOR THE ENVIRONMENT



**United Pacific**  
**132,000** sq ft

**Distribution Center**  
**Long Beach, CA**

**100%**

reduction in potable water used for landscaping

**40%**

reduction in total energy use due to high-efficiency mechanical and lighting systems

**82%**

of construction waste was diverted from landfills

## LEED ACCOMPLISHMENTS

### Sustainable Sites

- On-site bicycle storage, showers and changing areas for company employees.
- Preferred parking for low-emitting, fuel-efficient and carpool vehicles.
- Storm water is infiltrated on-site and treated to remove contaminants to reduce environmental impact on local waterways.

### Water Efficiency

- In addition to using reclaimed water, drought-tolerant plants and a high-efficiency irrigation system were installed to reduce the use of potable water for irrigation by 100%.

### Energy and Atmosphere

- Efficient HVAC equipment and a lighting system with daylight controls reduces energy consumption by over 30%.
- Enhanced commission verifies that the building's energy and water-related systems are performing as intended by the initial design.

### Indoor Environmental Quality

- Building ventilation systems was designed to provide enhanced levels of fresh outside air to building occupants.
- Interior finishes (plants, sealants, adhesives, coatings, carpet systems and composite wood) were selected with low levels of volatile organic compounds (VOCs) to reduce indoor air contamination.



# TABLE OF CONTENTS

## LED LIGHTING CLASSIC CAR & TRUCK

### LED HEADLIGHTS

7" Round LED Headlights	07
5 3/4" Round LED Headlights	15
5"X7" Rectangular LED Headlights	17
4"X6" Rectangular LED Headlights	19
7" Guide Style LED Headlights	25
LED Bulbs/Adaptors	42

### CHEVY LED LIGHTS

1930's Chevy	44
1940's Chevy	49
1950's Chevy	51
Chevy Camaro	61
Chevy Chevelle/Malibu	66
Chevy Corvette	69
Chevy Corvette/El Camino	72
Chevy El Camino/Wagon	73
Chevy Impala	74
Chevy Nova	78
1940s-50s Chevy Truck	80
1950s-60s Chevy Truck	83
1960-66 Chevy Truck	87
C10 Chevy Truck	89

### FORD LED LIGHTS

1928-34 Ford	98
1930s-40s Ford	105
1940s-50s Ford	115
Ford Mustang	121
Ford Thunderbird	124
Ford Truck/Bronco	125

### PONTIAC LED LIGHTS

1950s Pontiac	129
---------------	-----

### WILLIES/DODGE/VOLKS. LED LIGHTS

Willies/Dodge/Volkswagen	130
--------------------------	-----

### HONDA/PEDESTAL/BULLET LIGHTS

Honda/Pedestal/Bullet Lights	131
------------------------------	-----

### MISC. LIGHTING PRODUCTS

Rod and Bullet Lights	135
Brake/Tail/Cab Lights	137
Clearance Marker/Bullet Lights	139
Accessory Lights	143
LED Light Bars	145
LED License Light	149
Motorcycle Tail Lights/License Plates	155
LED Light Bulbs	157
LED Flashers/Load Resistors	162
Wiring/Plug Adaptors	164

### WARRANTY AND TERMS

Terms & Conditions/Ordering/Freight	165
Shipping/Policy/Claims	166
Warranty Policy>Returns	167
Returns/Disclaimer	167

### PRODUCT INDEX

Product Index	169
---------------	-----



LED LIGHTS  
**HEADLIGHTS**





**ULTRALIT - HEATED 7" LED Headlight  
With White Position Light**

- Features a heating system that automatically de-ices and defrosts the headlight lens
- Integrated monitoring system to turn off heating when snow & ice has cleared from lens
- Powerful 5700K white LEDs with 500 lumens on low function and 1900 lumens on high function
- Durable glass lens with heavy duty corrosion resistant aluminum housing. Resists shock and vibration
- Super bright white center position light bar with 4 LEDs. Position light wiring required
- Easy plug-in design with standard H4 style connector plug for ease of installation
- Compatible with any 12-24V DC setups
- Note: Due to large heat sink, modification to headlight bucket might be required
- DOT/SAE, FMVSS 108, IP67 water resistant rating
- Low function: draws 3.5A (heat on)/1.0A (heat off) at 12V
- High function: draws 5.3A (heat on)/2.5A (heat off) at 12V

Item Number	Description	Package	Pack
<b>31248</b>	Dual Function LED Halo	Boxed	1 Pc./Box



**7" LED Projection Headlight W/ Dual Function LED Halo**

- 7" headlight: 2,700 lumen high beam and 1,200 lumen low beam
- Dual color white/amber auxiliary LED halo ring with amber automatic override feature
- Die-cast housing and polycarbonate lens provide maximum protection
- Solid state design resists shock and vibration, IP67 weatherproof rating
- Easy installation. Fits OEM housing and plugs into existing headlight wiring harness. LED halo ring requires additional wiring installation

Item Number	Description	Package	Pack
<b>31496</b>	Dual Function LED Halo	Boxed	1 Pc./Box



**LED LIGHTS**  
**7" HEADLIGHTS**

**7" LED Headlight W/ LED Position Light Bar**

- High power LED headlight with LED position light bar
- Dual function headlight: low & high beam
- Aluminum housing with proprietary heat management provides maximum protection
- Solid state design resists shock and vibration
- Easy connection, fits OEM housing, plugs into existing wiring harness, position light requires additional wiring
- Super bright 2,000 lumen rated high beam output
- DOT/SAE approved

Item Number	Description	Package	Pack
31200	LED HL W/ LED Light Bar	Boxed	1 Pc./Box



**7" LED Headlight W/ Turn Signal & Position Light Bar**

- High power LED headlight w/ LED turn signal/position light bar
- Aluminum housing with proprietary heat management provides maximum protection for long-lasting performance
- Solid state design resists shock and vibration
- Easy connection, fits OEM housing, plugs into existing wiring harness
- LED position light requires additional wiring, pre-wired with 0.156" diameter male bullet plug
- Low beam rated at 900 lumens, 25 Watt, 5700K
- High beam rated at 1300 lumen, 25 Watt, 5700k

Item Number	Description	Package	Pack
31458	Amber LED Halo Ring	Boxed	1 Pc./Box
31459	White LED Halo Ring	Boxed	1 Pc./Box



**7" LED Dual Function Headlight**

- 5 high power LED 7" headlight, Philips LuminiLeds
- Reinforced aluminum reflector, rugged anti-vibration construction
- Improved visibility with whiter light output that is closer to the color temperature of daylight, IP67 rating
- Low beam 12-24V DC input, 1.7amp @ 12.8V DC, lumen output: 1020, FMVSS 108
- High beam 12-24V DC input, 2.6amp @ 12.8V DC, lumen output: 1600, FMVSS 108

Item Number	Description	Package	Pack
<b>31289</b>	LED Dual Function	Boxed	1 Pc./Box



**7" LED Dual Function Headlight - Chrome**

- 5 high power LED 7" headlight, Philips LuminiLeds
- Reinforced aluminum reflector, rugged anti-vibration construction
- Improved visibility with whiter light output that is closer to the color temperature of daylight, IP67 rating
- Low beam 12-24V DC input, 1.7amp @ 12.8V DC, lumen output: 1020, FMVSS 108
- High beam 12-24V DC input, 2.6amp @ 12.8V DC, lumen output: 1600, FMVSS 108

Item Number	Description	Package	Pack
<b>31391</b>	5 High Power LED	Boxed	1 Pc./Box



**LED LIGHTS**  
**7" HEADLIGHTS**

**7" LED Headlight W/ Daytime Running Light Bar**

- High power 3 LED headlight with 10 LED daytime running light bar
- 3 high power 7W LED for exceptional performance
- 900 lumens output on low and 1,600 lumens output on high
- White position light bar can be wired as daytime running light, amber position light bar can be wired as turn signal
- Easy installation, fits OEM housing, plugs into existing wiring harness
- Low beam application: 900 lumens, 9V-33V DC input, FMVSS 108
- High beam application: 1600 lumens, 9V-33V DC input, FMVSS 108

Item Number	Description	Package	Pack
31513	White LED Light Bar	Boxed	1 Pc./Box
31514	Amber LED Light Bar	Boxed	1 Pc./Box



**7" LED Crystal Headlight - Chrome or Blackout**

- 11 high power LED 7" crystal headlight, 1 single low beam center LED (green wire), 10 outer high beam LED (red wire)
- Solid state design resists shock and vibration
- Impact resistant polycarbonate lens provides protection
- Improved visibility with whiter light output that is closer to daylight
- Die-cast aluminum housing provides maximum protection
- Load resistor may be required for proper installation

Item Number	Description	Package	Pack
31355	Chrome Housing	Boxed	1 Pc./Box



**7" 24 LED Headlight W/ Dual Color Position Light**

- 24 LED high power 7" light with 8 dual color LED position light
- LED white/amber position light bar changes from white to amber when sequential light is activated
- Sequential amber position light can be connected for left-hand or right-hand operation
- High beam 5,000 lumens, low beam 2,000 lumens, position light white, 200 lumens, position light amber 125 lumens
- Some OE light housing may require modification to fit
- 12VDC - 24VDC, IP67 water resistant rating

Item Number	Description	Package	Pack
<b>36452</b>	24 LED Headlight	Boxed	1 Pc./Box

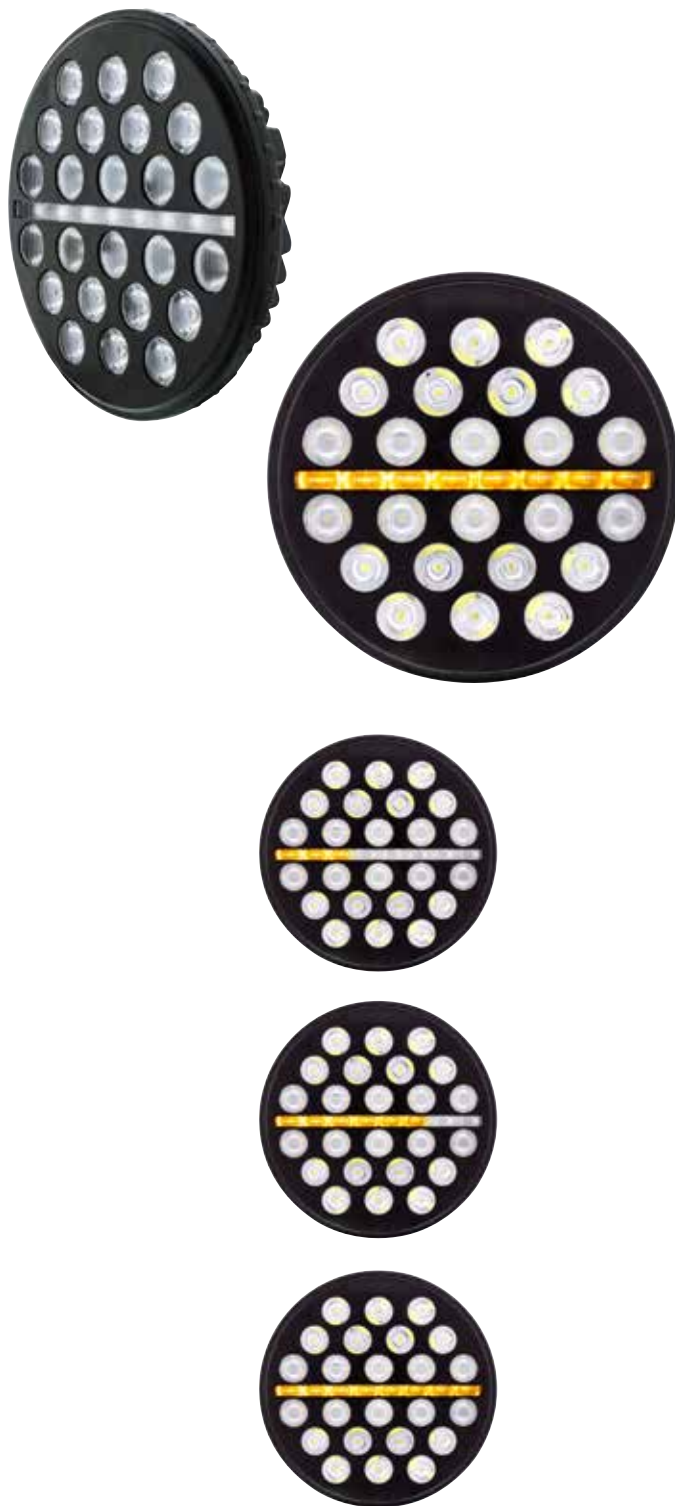

**7" LED Headlight W/ LED Halo Ring**

- Durable corrosion resistant polycarbonate lens & housing
- Solid state design resists shock and vibration
- Easy installation, fits OEM housing, plugs into existing wiring harness
- Low beam 500 lumens, 5700kelvin, 12-24V DC input
- High beam 950 lumens, 5700kelvin, 12-24V DC input

Item Number	Description	Package	Pack
<b>31084</b>	Amber LED Halo Ring	Boxed	1 Pc./Box



# 7" HEADLIGHTS

## 7" Crystal Headlight W/ 34 LED Position Light

- Reinforced multi-surfaced, aluminum reflector
- Aluminum reflector, anti-vibration structural design
- Features 34 white LED position lights
- H4/HB2/9003 halogen bulb: 12V 65/55W, replaces H6017/H6024

Item Number	Description	Package	Pack
31378	Amber LED Halo Ring	Boxed	1 Pc./Box
31379	White LED Halo Ring	Boxed	1 Pc./Box



## 7" Crystal Headlight W/ 6 Amber LED Position Light

- Super quality with reinforced multi-surfaced, aluminum reflector
- 6 amber Hi/Low function LED
- Rugged anti-vibration construction
- Includes 9007 halogen bulb and seal beam/H4 plug adapter
- LED for auxiliary/utility purposes
- 12V, dual function auxiliary LED with three wire hookup

Item Number	Description	Package	Pack
31247	Amber LED Halo Ring	Boxed	1 Pc./Box



## 7" Halogen Crystal Headlight W/ 10 LED Position Lights

- Reinforced multi-faceted, aluminum reflector, anti-vibration design
- Halogen bulb: HB2/9003 12V 65/55W, replaces H6017/H6024
- Reinforced aluminum reflector with rugged anti-vibration construction
- LED portion of the light for auxiliary/utility purposes
- Simple 3 wire hookups, white=ground, black=12V & function #1, red= 12V & function # 2

Item Number	Description	Package	Pack
S2010LED	10 Amber LED Position Lt.	Boxed	1 Pc./Box





**7" Crystal Headlight W/ LED Halo Ring**

- 7" crystal headlight with amber LED halo ring and 9007 bulb
- Reinforced multi-surfaced, aluminum reflector
- Features bright LED halo ring and standard 9007 bulb

Item Number	Description	Package	Pack
31284	Amber LED Halo Ring	Boxed	1 Pc./Box
31285	White LED Halo Ring	Boxed	1 Pc./Box



# 5 3/4" HEADLIGHTS

## 5 3/4" LED Headlight W/ Position Light

- 9 high power 5 3/4" LED headlight with LED position light bar
- High power bright LED high and low beam
- Reinforced aluminum reflector with rugged anti-vibration construction

Item Number	Description	Package	Pack
31259	9 Amber LED Position Lt.	Boxed	1 Pc./Box
31267	9 White LED Position Lt.	Boxed	1 Pc./Box



## ULTRALIT - 5 3/4" LED Headlight

### With 60 LED Dual Color Position Light, Amber & White LED

- Single CREE type LED with bright 1000 lumens output
- Features 30 dual color LEDs, bright white and amber LED position light bars
- Amber LEDs automatically overrides white LEDs when powered, perfect for use as turn signal
- Beautiful crystal polycarbonate front lens
- Reinforced aluminum reflector, rugged anti-vibration construction
- Perfect for all 4 headlamp systems in cars and trucks
- Easy plug-in design with H4 plug for main high beam/low beam function
- Wiring required for white and amber LED position light. Wiring code: Yellow wire=Amber LEDs, Red wire=White LEDs
- 12-24V DC compatible, DOT/SAE, FMVSS 108

Item Number	Description	Package	Pack
35887	Low Beam	Boxed	1 Pc./Box
35888	High Beam	Boxed	1 Pc./Box





**5 3/4" LED Headlight - Silver or Black**

- 8 high power 5 3/4" LED headlight
- Replaces H5001 bulb, DOT/SAE and FMVSS 108 compliant
- Easy connection, fits OEM housing, plugs into existing wiring harness
- Low beam 1,020 lumens, high beam 1,600 lumens

Item Number	Description	Package	Pack
31201	Silver Housing	Boxed	1 Pc./Box
31202	Black Housing	Boxed	1 Pc./Box



**5 3/4" Crystal Halogen Headlight W/ 5 LED Position Light**

- Flat crystal clear glass lens with chrome metal reflector
- 5 amber LED have high/low function, 12V
- 60/55 Watt H4 inner head light bulb is replaceable part # 30355
- Advance multi-faceted surface helps you see further

Item Number	Description	Package	Pack
S2005LED	5 Amber LED Position Lt.	Boxed	1 Pc./Box



# 5"X7" RECTANGULAR HEADLIGHTS

## "5X7" LED Crystal Headlight

- 5 high power LED crystal headlight w/ high and low beam function
- Reinforced aluminum reflector rugged anti-vibration construction
- Easy connection, fits OEM housing, plugs into existing wiring harness, position light requires additional wiring
- High beam 1,100 lumens, low beam 600 lumens

Item Number	Description	Package	Pack
31297	5 High Power LED	Boxed	1 Pc./Box



## "5X7" 7 LED Headlight W/ LED Light Bar

- 7 high power LED headlight with 3 LED position light bar
- High and low beam function
- Reinforced aluminum reflector
- Easy connection, fits OEM housing, plugs into existing wiring harness, position light requires additional wiring
- IP 66 rated, DOT/SAE approved
- High beam 1,680 lumens, 12V-24V DC input, 1.15 amps
- Low beam 2,850 lumens, 12V-24V DC input, 2.7 amps

Item Number	Description	Package	Pack
31120	7 High Power LED	Boxed	1 Pc./Box



## 5"X7" 22 High Power LED Headlight W/ LED Position Light

- LED dual function black rectangular headlight with 12 white LED position lights
- Ultra slim housing design for easy installation
- Rugged anti-vibration construction
- Easy connection, fits OEM housing or fender, plugs into existing wiring harness, position light requires additional wiring
- High beam, 4,000 lumens, low beam 2,000 lumens, position light 100 lumens, 12VDC-24VDC

Item Number	Description	Package	Pack
36450	22 LED Headlight-Black	Boxed	1 Pc./Box



**"5X7" ULTRALIT - Heated LED Headlight With White Position Light**

- Features a heating system that automatically de-ices and defrosts the headlight lens
- Integrated monitoring system to turn off heating when snow & ice has cleared from lens
- Powerful 5700K white LEDs with 500 lumens on low function and 1600 lumens on high function
- Durable glass lens with heavy duty corrosion resistant aluminum housing. Resists shock and vibration
- Super bright white center position light bar with 4 LEDs. Position light wiring required
- Easy plug-in design with standard H4 style connector plug for ease of installation
- Compatible with any 12-24V DC setups
- Note: Due to large heat sink, modification to headlight bucket might be required
- DOT/SAE, FMVSS 108, IP67 water resistant rating
- Low function: draws 3.5A (heat on)/1.0A (heat off) at 12V
- High function: draws 5.0A (heat on)/2.5A (heat off) at 12V

Item Number	Description	Package	Pack
31249	Heated LED Headlight	Boxed	1 Pc./Box



**"5X7" LED Headlight W/ LED Light Bar**

- 9 high power LED rectangular headlight w/ 6 white LED light bar
- Reinforced aluminum reflector, rugged anti-vibration construction
- IP67 weatherproof rating
- High beam 3,700 lumens, low beam 1,800 lumens

Item Number	Description	Package	Pack
34122	6 White LED Light Bar	Boxed	1 Pc./Box



**"5X7" LED Headlight W/ Polycarbonate Lens & Housing**

- 12 high power LED rectangular headlight with durable corrosion resistant polycarbonate lens & housing
- Solid state design resists shock and vibration
- Easy connection, fits OEM housing, plugs into existing wiring harness, position light requires additional wiring
- High beam 1,100 lumens, low beam 600 lumens

Item Number	Description	Package	Pack
31087	12 High Power LED	Boxed	1 Pc./Box

# 4"X6" RECTANGULAR HEADLIGHTS

## 4"X6" LED Crystal Headlight

- High power 5 LED crystal headlight w/ high and low beam function
- Reinforced aluminum reflector, rugged anti-vibration construction
- Replaces H4651/H4656
- SAE approved

Item Number	Description	Package	Pack
31365	Low Beam	Boxed	1 Pc./Box

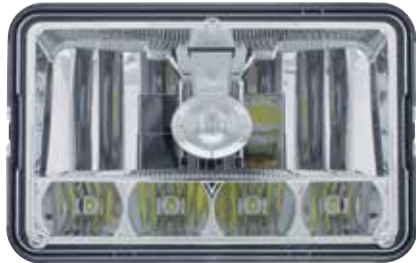

## 4"X6" LED Headlight W/ White LED Position Light

- 1 high power LED headlight w/ dual function 6 amber LED position light and polycarbonate lens
- Solid state design resists shock and vibration
- Die-cast aluminum housing provides maximum protection
- Load resistor may be required for proper installation, item #34205
- For offroad use only, 3 year warranty
- Application 12-24V DC input: 0.35 Amps/8.5 Watt

Item Number	Description	Package	Pack
31169	High Beam	Boxed	1 Pc./Box



## 4"X6" LED Headlight W/ Amber LED Position Light

- 1 high power LED headlight w/ dual function 6 amber LED position light and polycarbonate lens
- Solid state design resists shock and vibration
- Die-cast aluminum housing provides maximum protection
- Load resistor may be required for proper installation, item#34205
- For offroad use only, 3 year warranty
- Application 12-24V DC input: 0.35 Amps/8.5 Watt

Item Number	Description	Package	Pack
31237	Low Beam	Boxed	1 Pc./Box
31238	High Beam	Boxed	1 Pc./Box



**4"X6" LED Headlight W/ White Auxiliary Light**

- High power LED headlight with quality crystal clear polycarbonate lens
- 9 super bright white LED center light bar
- Waterproof die-cast housing provides maximum protection & durability
- OEM fit, plugs into existing wiring harness
- Sold individually, please specify low beam or high

Item Number	Description	Package	Pack
<b>31152</b>	Low Beam	Boxed	1 Pc./Box
<b>31153</b>	High Beam	Boxed	1 Pc./Box

**4"X6" LED Headlight W/ Amber Auxiliary Light**

- High power LED headlight w/ quality crystal clear polycarbonate lens
- 9 super bright amber LED center light bar
- Waterproof housing provides maximum protection & durability
- OEM fit, plugs into existing wiring harness
- Sold individually, please specify low beam or high

Item Number	Description	Package	Pack
<b>31150</b>	Low Beam	Boxed	1 Pc./Box
<b>31151</b>	High Beam	Boxed	1 Pc./Box

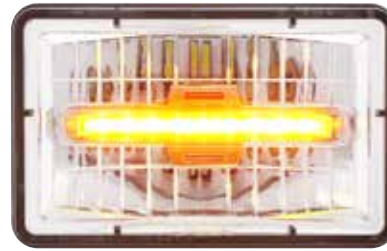

# 4"X6" RECTANGULAR HEADLIGHTS

## 4"X6" 9 High Power LED Headlight W/ LED Light Bar

- 9 super bright LED dual function headlight w/ 6 white LED light bar
- Die-cast aluminum housing provides maximum protection
- Headlight fits OEM housing, plugs into existing wiring harness
- For offroad use only

Item Number	Description	Package	Pack
34125	Low Beam	Boxed	1 Pc./Box



## 4"X6" 1 High Power CREE LED Headlight

- Improved visibility with light output that is closer to the color temperature of daylight
- Die-cast aluminum housing provides maximum protection
- Load resistor may be required for proper installation, item #34205
- Solid state design resists shock and vibration
- DOT/SAE and FMVSS 108

Item Number	Description	Package	Pack
31396	Low Beam	Boxed	1 Pc./Box
31397	High Beam	Boxed	1 Pc./Box



## 4"X6" 8 High Power LED Headlight

- 4"X6" rectangle headlight with 8 high power LEDs
- Improves visibility with whiter light output that is closer to daylight, output rated at 400 lumens
- Die-cast aluminum housing provides protection from the elements
- IP67 rating: Protects from dust and capable of withstanding water immersion, offering increased reliability and service life
- Dual power: use with 12VDC or 24VDC system, DOT/SAE approved

Item Number	Description	Package	Pack
31358	Low Beam	Boxed	1 Pc./Box
31359	High Beam	Boxed	1 Pc./Box



**4"X6" LED Headlight**

- 5 high power LED headlight w/ polycarbonate lens & housing
- Solid state design resists shock and vibration
- Easy connection, fits OEM housing, plugs into existing wiring harness, position light requires additional wiring
- High beam 1000 lumens, 6500kelvin, color temp. 12-24V DC input
- DOT/SAE FMVSS 108

Item Number	Description	Package	Pack
<b>31089</b>	High Beam	Boxed	1 Pc./Box
<b>31088</b>	Low Beam	Boxed	1 Pc./Box

**4"X6" Crystal Projection Headlight W/ LED Position Light**

- Crystal projection headlight w/ 6 white LED position light
- Reinforced aluminum reflector, rugged anti-vibration construction
- Sylvania halogen bulb: DOT 9005 X/S 12V 60W, replaces H4656
- Includes two 9005 adapter plugs (one 3 wire to 2 wire plug and one 2 wire plug)

Item Number	Description	Package	Pack
<b>31375</b>	Low Beam	Boxed	1 Pc./Box
<b>31376</b>	High Beam	Boxed	1 Pc./Box

**4"X6" 11 High Power LED Projection Headlight**

- 11 high power LED projection headlight with white LED position light
- Improved visibility with light output that is closer to the color temperature of daylight
- Die-cast aluminum housing provides maximum protection
- Solid state design resists shock and vibration
- DOT/SAE and FMVSS 108

Item Number	Description	Package	Pack
<b>31274</b>	Low Beam	Boxed	1 Pc./Box
<b>31275</b>	High Beam	Boxed	1 Pc./Box



# 4"X6" RECTANGULAR HEADLIGHTS

## 4"X6" Heated LED Headlight - Chrome

- Features a heating system that automatically de-ices the headlight according to ambient temperature
- Durable glass lens with heavy duty aluminum housing
- Plug & play with standard H4 style connector plug for easy install.
- Low beam 1,000 lumens, 12-24VDC, 20 Watts
- High beam 1,200 lumens, 12-24VDC, 24 Watts
- Dimensions: 6.6" x 4.2" x 3.2"

Item Number	Description	Package	Pack
34131	Low Beam	Boxed	1 Pc./Box
34132	High Beam	Boxed	1 Pc./Box

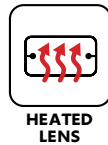
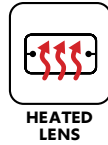

## 4"X6" Heated LED Headlight - Black

- Features a heating system that automatically de-ices the headlight according to ambient temperature
- Durable glass lens with heavy duty aluminum housing
- Plug & play with standard H4 style connector plug for easy install.
- Low beam 1,000 lumens, 12-24VDC, 20 Watts
- High beam 1,200 lumens, 12-24VDC, 24 Watts
- Dimensions: 6.6" x 4.2" x 3.2"

Item Number	Description	Package	Pack
34133	Low Beam	Boxed	1 Pc./Box
34134	High Beam	Boxed	1 Pc./Box

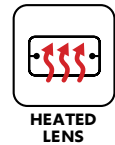
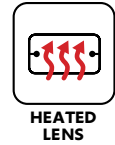



# 4"X6" RECTANGULAR HEADLIGHTS

## 4"X6" Crystal Headlight W/ 9 Amber LED Position Light

- 4"X6" rectangular crystal headlight w/ 9 amber LED position lights
- Reinforced aluminum reflector
- Rugged anti-vibration construction
- Sold individually, please specify low beam or high beam

Item Number	Description	Package	Pack
31373	Low Beam	Boxed	1 Pc./Box
31374	High Beam	Boxed	1 Pc./Box



## 4"X6" Crystal Headlight W/ 9 White LED Position Light

- 4"X6" rectangular crystal headlight with 9 white LED position lights
- Reinforced aluminum reflector
- Rugged anti-vibration construction
- Sold individually, please specify low beam or high beam

Item Number	Description	Package	Pack
31368	Low Beam	Boxed	1 Pc./Box
31369	High Beam	Boxed	1 Pc./Box



## 4"X6" 18 High Power LED Headlight W/ LED Position Lt.

- 18 high power LED headlight w/ 10 white LED position lights
- Ultra slim housing design for easier installation
- Rugged anti-vibration construction
- Easy connection, fits OEM housing, plugs into existing wiring harness, position light requires additional wiring
- High beam 3,500 lumens, 6500k, low beam 1,500 lumens/6500k position light 100 lumens, 12VDC-24VDC
- IP67 water resistant rating

Item Number	Description	Package	Pack
36449	18 LED Headlight	Boxed	1 Pc./Box

**LED LIGHTS**  
**7" GUIDE STYLE HEADLIGHTS**



**Classic Headlight H4 Bulb W/ 6 Amber LED**

- Beautiful high quality stainless steel or chrome plated headlight with crystal headlight bulb and 6 amber Hi/Low function LEDs
- LEDs for auxiliary/utility purpose
- Headlight available separately item # 31247, stainless housing # 30368, chrome housing # 30375
- 12V, dual function auxiliary LEDs have three wire hookup

Item Number	Description	Package	Pack
<b>32508</b>	Stainless Steel/Amber LED	Boxed	1 Pc./Box
<b>32509</b>	Chrome/Amber LED	Boxed	1 Pc./Box



**Guide 682-C Style Headlight H4 W/ 10 Amber LED Signal**

- Beautiful chrome plated or gloss black housing with chrome plated bezel
- Fully assembled with crystal clear halogen bulb with amber LED accent lights, item # S2010LED
- Includes top mounted dual function signal light with 5 amber LED and clear lens

Item Number	Description	Package	Pack
<b>32043</b>	10 Amber LED/Chrome	Boxed	1 Pc./Box
<b>32047</b>	10 Amber LED/Black	Boxed	1 Pc./Box



Bracket Sold Separately

**Guide 682-C Style Headlight H4 Bulb W/ 10 Amber LED**

- Beautiful gloss black or chrome plated housing with chrome plated bezel and 10 amber LED accent light
- Fully assembled with crystal halogen bulb with amber LED accent lights, item # S2010LED
- Ready to use, can also be painted to match your vehicle
- Included housing can be purchased separately, item # 32018

Item Number	Description	Package	Pack
<b>32655</b>	10 Amber LED/Black	Boxed	1 Pc./Box
<b>32035</b>	10 Amber LED/Chrome	Boxed	1 Pc./Box

# 7" GUIDE HEADLIGHTS

## Chrome Guide 682-C Style Headlight H4 W/ LED Signal

- Beautiful chrome plated headlight housing and bezel
- Fully assembled with crystal clear lens halogen headlight
- Headlight features 34 bright white or amber LED position light
- Includes top mount 5 amber LED w/ clear lens light, # 38029B
- Included housing can be purchased separately, item # 32007

Item Number	Description	Package	Pack
32441	34 White LED	Boxed	1 Pc./Box
32429	34 Amber LED	Boxed	1 Pc./Box



## Stainless Guide 682-C Style Headlight H4 W/ LED Signal

- Stainless steel guide 682-C headlight H4 with 34 LEDs and LED position light
- Fully assembled with crystal clear lens halogen headlight, #31379
- Headlight features 34 bright white or amber LED position light
- Includes top mount 5 amber LED w/ clear lens light, # 38029B
- Included housing can be purchased separately, item # 32005

Item Number	Description	Package	Pack
32437	34 White LED	Boxed	1 Pc./Box
32425	34 Amber LED	Boxed	1 Pc./Box



## Guide 682-C Style Headlight H4 Bulb W/ 6 Amber LED

- Crystal headlight bulb with Amber Hi/Low function LED
- LEDs for auxiliary/utility purposes
- 12V, dual function auxiliary LEDs have three wire hookup
- Headlight item# 31247, stainless housing # 32006, chrome housing # 32008, black housing # 32009

Item Number	Description	Package	Pack
32557	Stainless Steel/Amber LED	Boxed	1 Pc./Box
32558	Chrome Guide/Amber LED	Boxed	1 Pc./Box
32559	Black Guide/Amber LED	Boxed	1 Pc./Box



**Classic Half Moon Headlight 11 LED & LED Turn Signal**

- Highly polished 304 stainless steel headlight housing and "Classic" style bezel
- Highly polished stainless steel finish for durability and shine
- Headlight features 11 bright LEDs and 4 amber LED turn signal

Item Number	Housing	Lens	LED	Package	Pack
<b>31570</b>	Stainless	Amber	Amber	Boxed	1 Pc./Box
<b>31571</b>	Stainless	Clear	Amber	Boxed	1 Pc./Box



Bracket Sold Separately

**Classic Half Moon Headlight H4 W/ LED Turn Signal**

- Highly polished 304 stainless steel headlight housing "Classic" style bezel
- Fully assembled with crystal halogen bulb with amber LED accent lights, item # S2010LED
- Includes 4 amber LED with amber lens, turn signal lens #38505B
- Included housing can be purchased separately, item # 30470-1

Item Number	Description	Package	Pack
<b>32059</b>	4 Amber LED Turn Signal	Boxed	1 Pc./Box



**Black Guide Headlight 11 LED Bulb**

- Gloss black powder coated steel headlight housing and beautiful chrome plated bezel and housing
- Fully assembled with LED headlight with crystal clear lens
- Single high power low beam LED and 10 outer LED w/ black housing
- Included housing can be purchased separately, item # 32018

Item Number	Description	Package	Pack
<b>32659</b>	11 LED/Chrome	Boxed	1 Pc./Box

# 7" GUIDE HEADLIGHTS

## Bullet Classic Embossed Stripe 11 LED Crystal Headlight

- 7" stainless steel classic embossed stripe headlight with 11 LED crystal halogen
- Classic look with 3 raised ribs
- Universal ball mount fits any application
- 304 high grade stainless steel, rust free

Item Number	Description	Package	Pack
32763	11 White LED	Boxed	1 Pc./Box
32771	11 White LED	Boxed	1 Pc./Box



## Bullet Classic Headlight W/ 6 Amber LED Signal

- Highly polished 304 stainless steel headlight housing and "Bullet" style bezel
- Fully assembled with crystal clear lens halogen headlight
- Headlight features 34 bright white LED position light
- Includes 4 amber LED turn signal light single function

Item Number	Housing	Lens	LED	Package	Pack
32468	Stainless	Amber	Amber	Boxed	1 Pc./Box
32469	Stainless	Clear	Amber	Boxed	1 Pc./Box



## Bullet Half Moon Headlight W/ 6 Amber LED Signal

- Highly polished 304 stainless steel headlight housing and "Bullet" style bezel
- Fully assembled with crystal clear lens halogen headlight
- Headlight features 34 bright white LED position light
- Includes 4 amber LED turn signal light single function

Item Number	Housing	Lens	LED	Package	Pack
32452	Stainless	Amber	Amber	Boxed	1 Pc./Box
32453	Stainless	Clear	Amber	Boxed	1 Pc./Box



**Bullet Classic Headlight H4 W/ Amber LED & Signal**

- Highly polished 304 stainless steel headlight housing and "Bullet" style bezel
- Fully assembled with crystal clear lens LED headlight
- Headlight features 34 bright amber LED position light
- Includes 4 amber LED turn signal light

Item Number	Housing	Lens	LED	Package	Pack
<b>32464</b>	Stainless	Amber	Amber	Boxed	1 Pc./Box
<b>32465</b>	Stainless	Clear	Amber	Boxed	1 Pc./Box



**Classic Half Moon Headlight H4 W/ Amber LED & Signal**

- Highly polished 304 stainless steel headlight housing and "Classic" style bezel
- Fully assembled with crystal clear lens LED headlight
- Headlight features 34 bright amber LED position light
- Includes 4 amber LED turn signal light

Item Number	Housing	Lens	LED	Package	Pack
<b>32456</b>	Stainless	Amber	Amber	Boxed	1 Pc./Box
<b>32457</b>	Stainless	Clear	Amber	Boxed	1 Pc./Box



**Classic Headlight H4 W/ 34 Amber LED & LED Turn Signal**

- Beautiful chrome plated housing and bezel
- Fully assembled with crystal clear lens LED headlight, item #31378
- Headlight features 34 bright amber LED position light
- Includes 4 amber LED turn signal light

Item Number	Description	Package	Pack
<b>32480</b>	Amber LED/Amber Lens	Boxed	1 Pc./Box
<b>32481</b>	Amber LED/Clear Lens	Boxed	1 Pc./Box

# 7" GUIDE HEADLIGHTS

## Classic Headlight Crystal H4 W/ LED Turn Signal

- Beautiful chrome plated or highly polished 304 stainless steel headlight housing and "Classic" style bezel
- Fully assembled with H4 halogen bulb and 4 amber LED turn signal
- High quality chrome or stainless steel finish for durability and shine

Item Number	Housing	Lens	LED	Package	Pack
31773	Chrome	Amber	Amber	Boxed	1 Pc./Box
31758	Stainless	Amber	Amber	Boxed	1 Pc./Box



## Bullet Embossed Stripe Headlight W/ 34 White LED

- Stainless steel classic embossed stripe headlight with 34 LED crystal halogen
- Classic look with 3 raised ribs
- Universal ball mount fits any application
- 304 high grade stainless steel, rust free

Item Number	Description	Package	Pack
32766	34 Amber LED	Boxed	1 Pc./Box
32767	34 White LED	Boxed	1 Pc./Box



## Bullet Embossed Stripe Headlight W/ 34 Amber LED

- Stainless steel bullet embossed stripe headlight with 34 amber LED crystal halogen
- Classic look with 3 raised ribs
- Distinctive sharp edge "bullet" style rim
- Universal ball mount fits any application
- 304 high grade stainless steel, rust free

Item Number	Description	Package	Pack
32774	34 Amber LED	Boxed	1 Pc./Box
32775	34 White LED	Boxed	1 Pc./Box





**Classic Embossed Stripe Headlight**

- 7" round stainless steel classic embossed stripe headlight w/ 5 LED
- Classic look with 3 raised ribs
- Universal ball mount fits any application
- 304 high grade stainless steel, rust free

Item Number	Description	Package	Pack
32762	5 LED	Boxed	1 Pc./Box
32770	5 LED	Boxed	1 Pc./Box



**Classic Embossed Stripe Headlight W/ 6 Amber LED**

- Stainless steel classic embossed stripe headlight w/ 6 amber LED crystal halogen
- Classic look with 3 raised ribs
- Universal ball mount fits any application
- 304 high grade stainless steel, rust free

Item Number	Description	Package	Pack
32769	6 Amber LED	Boxed	1 Pc./Box



**Bullet Embossed Stripe Headlight W/ 6 Amber LED**

- Stainless steel bullet embossed stripe headlight w/ 6 amber LED crystal halogen
- Classic look with 3 raised ribs
- Universal ball mount fits any application
- 304 high grade stainless steel, rust free

Item Number	Description	Package	Pack
32777	6 Amber LED	Boxed	1 Pc./Box

# 7" GUIDE HEADLIGHTS

## Bullet Embossed Stripe Headlight W/ 6 Amber LED

- Stainless steel bullet embossed stripe headlight w/ 6 amber LED & dual mode LED signal
- Classic look with 3 raised ribs
- Universal ball mount fits any application
- 304 high grade stainless steel, rust free

Item Number	Description	Package	Pack
32760	6 Amber LED/Amber Lens	Boxed	1 Pc./Box
32761	6 Amber LED/Clear Lens	Boxed	1 Pc./Box



## Classic Embossed Stripe Headlight W/ 6 Amber LED

- Stainless steel classic embossed stripe headlight w/ 6 amber LED & dual mode LED signal
- Classic look with 3 raised ribs
- Dual function LED turn signal light built into top of rim
- Universal ball mount fits any application
- 304 high grade stainless steel, rust free

Item Number	Description	Package	Pack
32744	6 Amber LED/Amber Lens	Boxed	1 Pc./Box
32745	6 Amber LED/Clear Lens	Boxed	1 Pc./Box



## Dietz Style Headlight H4 Bulb W/ 6 Amber LED

- Chrome complete assembly
- Crystal headlight bulb with amber hi/low function LEDs
- LED for auxiliary/utility purposes
- 12V, dual function auxiliary LED have three wire hookup

Item Number	Description	Package	Pack
32695	Chrome/6 Amber LED	Boxed	1 Pc./Box



## Chrome Dietz Style Headlight H4 Bulb W/ 6 Amber LED

- Stainless steel complete assembly
- Crystal headlight bulb with amber hi/low function LEDs
- LED for auxiliary/utility purposes
- 12V, dual function auxiliary LED have three wire hookup

Item Number	Description	Package	Pack
32696	Stainless/6 Amber LED	Boxed	1 Pc./Box



## Dietz Style Headlight W/ 10 LED Headlamp Bulb

- Gloss black powder coated or highly polished 304 stainless steel "Dietz" style headlight with crystal lens and 10 LED headlamp bulb
- Single high power low beam LED and 10 outer LEDs
- For street rods and 1928-34 Ford cars and trucks

Item Number	Description	Package	Pack
A5022BCL	Black/Stainless	Boxed	1 Pc./Box
A5022SSE	Stainless Steel	Boxed	1 Pc./Box



**Chopper Headlight W/ Smooth Visor W/ 34 LED**

- Chrome aluminum billet style housing with smooth visor to give that ultra slick look
- Same billet style headlight found on custom motorcycles/choppers
- Fully assembled w/ crystal clear lens and 34 bright LED position light
- Included housing can be purchased separately, item # 32181

Item Number	Description	Package	Pack
32519	34 Amber LED	Boxed	1 Pc./Box
32520	34 White LED	Boxed	1 Pc./Box



**Chopper Headlight W/ Smooth Visor H4 Bulb W/ 34 LED**

- Ultra slick looking billet style chrome plated aluminum housing with smooth visor
- Fully assembled with crystal clear lens LED headlight, item # 31378
- Headlight features 34 bright LED position light
- Included housing can be purchased separately, item # 32181

Item Number	Description	Package	Pack
32511	34 Amber LED Position Lt.	Boxed	1 Pc./Box
32512	34 White LED Position Lt.	Boxed	1 Pc./Box



**Billet Style Groove Headlight W/H4 Bulb**

- Black "Billet" style groove headlight with H4 bulb and 34 LED position light
- Fully assembled with crystal clear lens LED headlight, item # 31379
- Headlight features 34 bright LED position light
- Included housing can be purchased separately, item # 31498

Item Number	Description	Package	Pack
32668	34 Amber LED Position Lt.	Boxed	1 Pc./Box



**Billet Style Groove Headlight W/ Visor H4 Bulb**

- Black "Billet" style groove headlight with visor, H4 bulb and 34 amber or white LED position light
- Fully assembled with crystal clear lens LED headlight, item # 31379
- Headlight features 34 bright LED position light
- Included housing can be purchased separately, item # 31498

Item Number	Description	Package	Pack
32681	34 Amber LED Position Lt.	Boxed	1 Pc./Box
32682	34 White LED Position Lt.	Boxed	1 Pc./Box



# 7" GUIDE HEADLIGHTS

## Billet Style Groove Headlight W/ Visor 5 LED Bulb

- Gloss black powder coated "Billet" style headlight housing
- Fully assembled with dual function LED headlight, item # 31391
- LED headlight features dual Hi/Lo function, chrome accent center bar and crystal clear lens
- Included housing can be purchased separately, item # 31497

Item Number	Description	Package	Pack
32677	5 LED Dual Function	Boxed	1 Pc./Box



## Billet Style Groove Headlight W/ Visor 5 LED Bulb

- Gloss black powder coated "Billet" style headlight housing
- Fully assembled with dual function LED headlight, item # 31391
- LED headlight features dual Hi/Lo function, chrome accent center bar and crystal clear lens
- Included housing can be purchased separately, item # 31498

Item Number	Description	Package	Pack
32691	5 LED Dual Function	Boxed	1 Pc./Box



## Billet Style Groove Headlight W/ LED Halo Rim

- Gloss black powder coated "Billet" style groove headlight 9007 bulb with white LED halo rim
- Included housing can be purchased separately, item # 31497

Item Number	Description	Package	Pack
32670	LED Halo Rim	Boxed	1 Pc./Box



## Billet Style Groove Headlight W/ Visor Halo LED

- Black "Billet" style groove headlight with visor, 9007 bulb and LED halo rim
- Housing item # 31498 light bulb item # 31285
- Included housing can be purchased separately, item # 31497

Item Number	Description	Package	Pack
32683	Amber LED Halo	Boxed	1 Pc./Box
32684	White LED Halo	Boxed	1 Pc./Box



**Billet Style Groove Headlight 5 LED Bulb**

- Gloss black powder coated "Billet" style headlight housing
- Fully assembled with dual function LED headlight, item # 31381
- LED headlight features dual Hi/Lo function, black accent center bar and crystal clear lens
- Included housing can be purchased separately, item # 31497

Item Number	Description	Package	Pack
32676	5 LED Dual Function	Boxed	1 Pc./Box



**Billet Style Groove Headlight W / Visor 5 LED Bulb**

- Gloss black powder coated "Billet" style headlight housing
- Fully assembled with dual function LED headlight, item # 31389
- LED headlight features dual Hi/Lo function, black accent center bar and crystal clear lens
- Included housing can be purchased separately, item # 31498

Item Number	Description	Package	Pack
32690	5 LED Dual Function	Boxed	1 Pc./Box



**Billet Style Groove Headlight W/ 11 LED**

- Gloss black powder coated "Billet" style headlight housing
- Single high power low beam LED and 10 outer LEDs
- Included housing can be purchased separately, item # 31497

Item Number	Description	Package	Pack
32675	11 LED/Chrome	Boxed	1 Pc./Box



**Billet Style Groove Headlight W/ Visor 11 LED**

- Gloss black powder coated "Billet" style headlight housing
- Single high power low beam LED and 10 outer LEDs
- Included housing can be purchased separately, item # 31497

Item Number	Description	Package	Pack
32689	11 LED/Chrome	Boxed	1 Pc./Box



# 7" GUIDE HEADLIGHTS

## Classic Headlight 11 LED W/ LED Turn Signal

- Highly polished 304 stainless steel headlight housing and "Bullet" style bezel
- Fully assembled with crystal clear lens LED headlight
- Headlight features 11 bright LEDs
- Includes 4 amber or white LED turn signal light

Item Number	Description	Package	Pack
31574	Amber LED Turn Signal	Boxed	1 Pc./Box
31575	White LED Turn Signal	Boxed	1 Pc./Box



## Classic Headlight H4 W/ Amber LED Turn Signal

- Beautiful chrome plated or stainless steel headlight housing and "Classic" style bezel
- Fully assembled with H4 halogen bulb and 4 amber LED turn signal
- High quality chrome or stainless steel finish for durability and shine

Item Number	Housing	Lens	LED	Package	Pack
31770	Chrome	Amber	Amber	Boxed	1 Pc./Box
31771	Chrome	Clear	Amber	Boxed	1 Pc./Box
31755	Stainless	Amber	Amber	Boxed	1 Pc./Box



## Classic Headlight 6014 Bulb & LED Turn Signal

- Highly polished 304 stainless steel headlight housing and "Bullet" style bezel
- Fully assembled headlight with H6014 halogen seal beam bulb
- Includes 4 amber LEDs with amber or clear lens

Item Number	Housing	Lens	LED	Package	Pack
31704	Stainless	Amber	Amber	Boxed	1 Pc./Box
31705	Stainless	Clear	Amber	Boxed	1 Pc./Box



**Bullet Classic Headlight H6024 LED Turn Signal**

- Highly polished 304 stainless steel headlight housing and "Bullet" style bezel
- Fully assembled headlight with H4 halogen bulb
- Includes 4 amber LED turn signal with amber or clear lens

Item Number	Housing	Lens	LED	Package	Pack
<b>31740</b>	Stainless	Amber	Amber	Boxed	1 Pc./Box
<b>31741</b>	Stainless	Clear	Amber	Boxed	1 Pc./Box



**Bullet Classic Headlight H6024 LED Turn Signal**

- Highly polished 304 stainless steel headlight housing and "Bullet" style bezel
- Fully assembled headlight with H6024 halogen bulb
- Includes 4 amber LEDs with amber or clear lens

Item Number	Housing	Lens	LED	Package	Pack
<b>31737</b>	Stainless	Amber	Amber	Boxed	1 Pc./Box
<b>31738</b>	Stainless	Clear	Amber	Boxed	1 Pc./Box



**Bullet Classic Headlight H6014 & LED Turn Signal**

- Highly polished 304 stainless steel headlight housing and "Bullet" style bezel
- Fully assembled headlight with H6014 halogen seal beam bulb
- Includes 4 amber LED turn signal with amber or clear lens

Item Number	Housing	Lens	LED	Package	Pack
<b>31734</b>	Stainless	Amber	Amber	Boxed	1 Pc./Box
<b>31735</b>	Stainless	Clear	Amber	Boxed	1 Pc./Box

# 7" GUIDE HEADLIGHTS

## Classic Half Moon Headlight H4 Bulb & LED Turn Signal

- Highly polished 304 stainless steel headlight housing and "Classic" style bezel
- Fully assembled headlight with H4 halogen bulb
- Includes 4 amber LEDs with amber or clear lens turn signal

Item Number	Housing	Lens	LED	Package	Pack
31725	Stainless	Amber	Amber	Boxed	1 Pc./Box
31726	Stainless	Clear	Amber	Boxed	1 Pc./Box



## Bullet Half Moon Headlight H4 Bulb & LED Turn Signal

- Highly polished 304 stainless steel headlight housing and "Bullet" style bezel
- Fully assembled headlight with H4 halogen bulb
- Includes 4 amber LEDs with amber or clear lens turn signal

Item Number	Housing	Lens	LED	Package	Pack
31710	Stainless	Amber	Amber	Boxed	1 Pc./Box
31711	Stainless	Clear	Amber	Boxed	1 Pc./Box



## Bullet Half Moon Headlight H6024 Bulb & LED Turn Signal

- Highly polished 304 stainless steel headlight housing and "Bullet" style bezel
- Fully assembled headlight with H6024 halogen bulb
- Includes 4 amber LEDs with amber lens turn signal

Item Number	Housing	Lens	LED	Package	Pack
31707	Stainless	Amber	Amber	Boxed	1 Pc./Box





**Guide Headlight With 5 LED bulb**

- Gloss black powder coated steel headlight and beautiful chrome plated bezel
- Fully assembled with dual function LED headlight, item # 31289
- LED headlight features dual Hi/Lo function, black or chrome accent center bar and crystal clear lens
- Ready to use, can also be painted to match your vehicle
- Included housing can be purchased separately, item # 32018

Item Number	Description	Package	Pack
<b>32660</b>	Black Accent	Boxed	1 Pc./Box
<b>32661</b>	Chrome Accent	Boxed	1 Pc./Box



**Guide Headlight 9007 Bulb With LED Halo Rim**

- Gloss black powder coated steel headlight housing and beautiful chrome plated bezel
- Headlight features bright amber or white LED position light
- Gloss black ready to use, can also be painted to match your vehicle
- Housing item # 32018, light bulb item # 31284
- 304 high grade stainless steel, rust free

Item Number	Description	Package	Pack
<b>32662</b>	Amber LED Halo	Boxed	1 Pc./Box
<b>32663</b>	White LED Halo	Boxed	1 Pc./Box



**Guide 682-C Headlight H4 Bulb W/ 34 LED**

- Gloss black powder coated steel headlight housing and beautiful chrome plated bezel
- Fully assembled with crystal clear lens LED headlight
- Headlight features 34 bright amber or white LED position light
- Ready to use, can also be painted to match your vehicle
- Included housing can be purchased separately, item # 32018

Item Number	Description	Package	Pack
<b>32653</b>	34 Amber LED Position Lt.	Boxed	1 Pc./Box
<b>32654</b>	34 White LED Position Lt.	Boxed	1 Pc./Box

# 7" GUIDE HEADLIGHTS

## Classic Headlight H6024 Bulb & Amber LED Turn Signal

- Beautiful stainless steel headlight housing and "Classic" style bezel
- Fully assembled w/ H6024 halogen bulb and 4 amber LED turn signal
- High quality chrome or stainless steel finish for durability and shine

Item Number	Housing	Lens	LED	Package	Pack
31752	Stainless	Amber	Amber	Boxed	1 Pc./Box
31753	Stainless	Clear	Amber	Boxed	1 Pc./Box



## Classic Headlight H6024 Bulb & Amber LED Turn Signal

- Beautiful chrome plated headlight housing and "Classic" style bezel
- Fully assembled w/ H6024 halogen bulb and 4 amber LED turn signal
- High quality chrome or stainless steel finish for durability and shine

Item Number	Housing	Lens	LED	Package	Pack
31767	Chrome	Amber	Amber	Boxed	1 Pc./Box
31768	Chrome	Clear	Amber	Boxed	1 Pc./Box



## Black Guide 682-C Style Headlight H6024 & LED Signal

- Gloss black powder coated steel headlight with matching top mount cover and beautiful chrome plated bezel
- Fully assembled with H6024 halogen bulb, item # 30356
- Includes top mount 5 amber LED with clear lens item # 38029B
- Included housing can be purchased separately, item # 32009

Item Number	Description	Package	Pack
31555	5 LED Turn Signal	Boxed	1 Pc./Box



## Black Guide 682-C Headlight & Original Style LED Signal

- Gloss black powder coated steel headlight w/ matching top mount cover and beautiful chrome plated bezel
- Fully assembled with H4 halogen bulb, item # A5023-3
- Features top mounted amber LED with clear lens signal light
- Ready to use, can also be painted to match your vehicle

Item Number	Description	Package	Pack
32639	Black Guide 682-C	Boxed	1 Pc./Box



**TRIPLE COLOR HIGH POWER 12V H11 LED BULBS**

**WHITE/YELLOW/W+Y (2-PACK)**

- Specially engineered 240 degree wide angle dual color LED design
- Primary 6000K white color temp. LED with 1400 lumen output
- Secondary 3000K bright yellow color temp. LED w/ 1400 lumen output
- Features highly efficient rear heatsink design to help dissipate heat and prolong bulb life
- Small form factor in-line LED driver ballast
- Direct plug-n-play to H11 housing and socket
- Includes quality high temp rubber seal on bulb body
- Primary white LED comes on by default. To switch over to secondary or tertiary, simply turn off and on within 10 seconds
- Warning: yellow LED is designed for fog light use only, not to be used as normal driving light

Item Number	LEDs	Lens	Package	Pack
36468	2	White	Carded	2 Pc./Card



**2** SOLD IN PAIRS

**High Power 9006/HB4 LED Bulb (2 Pack)**

- 20W low beam application, 2300 lumen output
- Forced convection design with cooling fan and heat sink, to increase service life
- Includes driver/controller for easy installation, made to fit most 9006/HB4 applications
- Driver/controller is approximately 2 1/4" L x 15/16" W x 5/8" H

Item Number	LEDs	Lens	Package	Pack
36513	1 Amber	Amber	Carded	2 Pc./Card



**2** SOLD IN PAIRS

**High Power 9006/HB4 LED Bulb**

- 2 CREE high power white LEDs, 10 watt low beam application
- Fan-less design
- 1200 lumen output

Item Number	LEDs	Lens	Package	Pack
36904	2	White	Carded	1 Pc./Card



**High Power 9005/HB3 LED Headlamp Bulb**

- 12V, high beam and low beam function
- High beam 100 watt/low beam 80 watt
- Sold in pairs

Item Number	Description	Package	Pack
39132	High/Low Beam	Carded	2 Pc./Card



**2** SOLD IN PAIRS

**High Power H4 LED Bulb with Fan**

- 23 watt low beam application 25 watt high beam application
- 1800 lumen low beam output
- 2400 lumen high beam output
- Includes driver/controller for easy installation, replaces any H4 bulb
- Driver/controller is approximately 2 3/16" L x 7/8" W x 5/8" H

Item Number	LEDs	Lens	Package	Pack
36512	1	White	Carded	1 Pc./Card



**8 Watt High Power H8/H11/H16 LED Bulb**

- High power H8/H11/H16 LED bulb
- 8 watt CREE LED, CREE LED are made in the U.S.A
- 500 lumens / 6000k brightness, 12V application
- Fan-less design, proprietary integrated heat sink design dissipates heat without use of external cooling fan
- Use of external cooling fan
- Includes in-line ballast

Item Number	LEDs	Lens	Package	Pack
36927	1	Clear	Carded	1 Pc./Card



# LED BULBS/ADAPTERS

### 3 Contact Female Headlight Pigtail For H4 Halogen Bulb

- 3 contact female pigtail for H4 halogen bulb
- High heat resistant nylon wires in black, green and red color skin
- OEM # 01A-13076

Item Number	Description	Package	Pack
34222	Headlight Pigtail	Bulk	1 Pc./Bulk

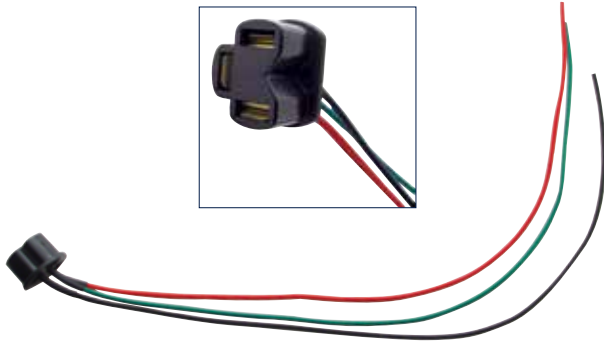

### LED Headlight PWM Anti-Flicker Module & Adaptor

- Works with most vehicles using pulse width modulated electrical systems, such as 2007-present Jeep JK
- Eliminates flicker on LED headlamps
- Adapts common H13 plug to H4 plug used by most LED headlights

Item Number	Description	Package	Pack
34217B	Anti-Flicker Module/Adapt.	Carded	1 Pc./Card



### H4 Headlight Relay Harness Kit

- Sends high amperage to headlights
- Corrects dim lights on classic cars and hot rods
- Works on original style 6014 sealed beams
- 12 Volt

Item Number	Description	Package	Pack
34263	Headlight Relay Harness	Carded	1 Pc./Card

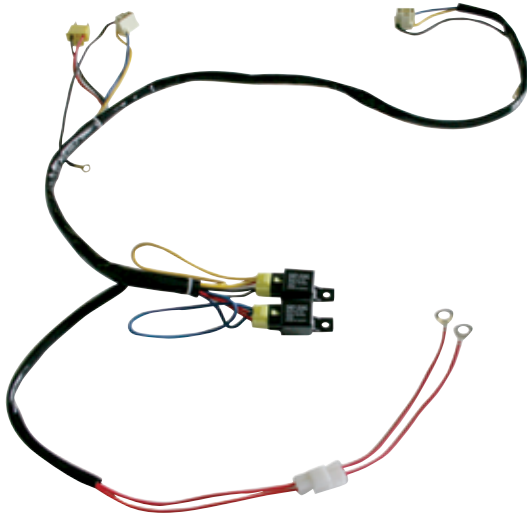

### 9005/9006 Headlight Relay Harness Kit

- Sends high amperage to headlamps
- Corrects dim lights on classic cars and hot rods
- Select proper kit to match your type of headlamp bulbs
- 12 Volt

Item Number	Description	Package	Pack
34264	Headlight Relay Harness	Carded	1 Pc./Card

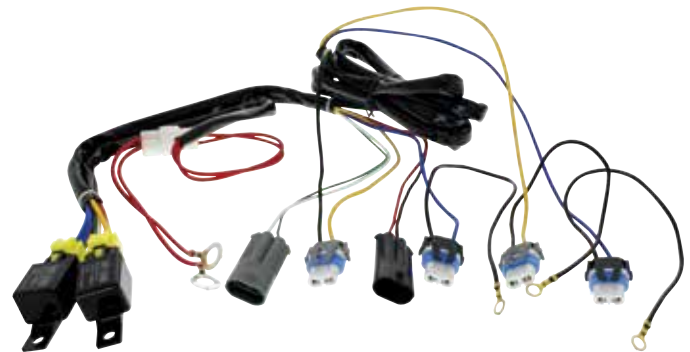

### Dual Function LED Control Module

- Add dual function high/low brightness to 31378 and 31379 headlamps with 34 LED accent lights
- Built in split operation for motorcycle applications
- Easy plug & play hookup, wiring instructions included
- Sold individually, for 12 volt LED use only

Item Number	Description	Package	Pack
31372	LED Control Module	Carded	1 Pc./Card

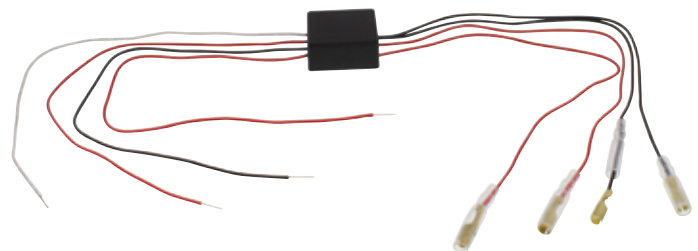



*1933-36 Chevy Passenger Car*

**30 LED Tail Light**

- 30 super bright red LEDs, driver side includes a 6 white LED license light
- Easy installation in original Tail Light housing with 1156 plug
- Epoxy coated, fully sealed electronics
- Solid state circuit boards are designed for 7.7 - 14.0 VDC
- Licensed by General Motors

Item Number	LEDs	Lens	Application	Pack
CTL3336LED-R	30 Red	Red	Passenger	1 Pc./Card

*1937-38 Chevy Passenger Car*

**27 LED Sequential Tail Light Assembly With Stainless Steel Housing**

- 27 super bright red LEDs with high quality polycarbonate lens
- Includes LED license illuminator lens w/ 6 super bright white LEDs
- Features sequential function with selector switch to control sequential function off/on
- Also features brake attention option with sequence-once function
- Recommend to upgrade under dash flasher to item # 90652 or 90649 LED flasher

Item Number	LEDs	Lens	Application	Pack
110413	27 Red	Red	Driver	1 Pc./Box
110414	27 Red	Red	Passenger	1 Pc./Box



*1937-38 Chevy Car & 1940-53 Chevy Truck*

**27 LED Sequential Tail Light Assembly With Black Housing**

- 27 red LEDs with black powder coated housing & stainless rim and high quality polycarbonate lens
- Driver side includes LED license illuminator lens with 6 super bright white LEDs
- Also features brake attention option with sequence-once function
- Recommend to upgrade under dash flasher to item # 90652 or 90649 LED flasher

Item Number	LEDs	Lens	Application	Pack
110411	Red/White	Red	Driver	1 Pc./Box
110412	Red	Red	Passenger	1 Pc./Box

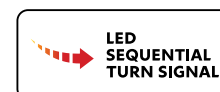

1937-38 Chevy Passenger Car

**45 LED Tail Light w/ Stainless Steel Housing**

- 45 red LED tail light and 6 white LED license plate light
- High quality injection molded polycarbonate lens
- Recommend to upgrade under dash flasher to item # 90652 or 90649 LED flasher

Item Number	LEDs	Lens	Application	Pack
<b>C3704RL</b>	45 Red	Red	Driver	1 Pc./Box
<b>C3704RR</b>	45 Red	Red	Passenger	1 Pc./Box



1940-53 Chevy & GMC Truck

**27 LED Sequential Tail Light w/ Black Housing**

- 27 super bright red LEDs with high quality polycarbonate lens
- Includes LED license illuminator lens w/ 6 super bright white LEDs
- Features sequential function with selector switch to control sequential function off/on
- Also features brake attention option with sequence-once function
- Energy efficient solid-state circuit board for 12V DC systems
- Recommend to upgrade under dash flasher to item # 90652 or 90649 LED flasher

Item Number	LEDs	Lens	Application	Pack
<b>110415</b>	27 Red	Red	Driver	1 Pc./Box
<b>110416</b>	27 Red	Red	Passenger	1 Pc./Box

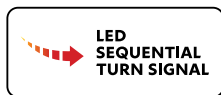

*1937-38 Chevy Passenger Car*

**23 LED Tail Light W/ Stainless Steel Housing & Blue Dot**

- 23 super bright LED with center mounted blue dot on high quality polycarbonate lens
- Includes 6 white LED for license plate
- Blue dot can be controlled independently with additional wiring
- Recommend to upgrade under dash flasher to item # 90652 or 90649 LED flasher

Item Number	LEDs	Lens	Application	Pack
<b>C3704RLBD</b>	Red/White	Red	Driver	1 Pc./Box
<b>C3704RRBD</b>	Red	Red	Passenger	1 Pc./Box



*1937-38 Chevy Car & 1940-53 Chevy Truck*

**27 LED Sequential Tail Light Lens**

- 27 super bright red LEDs with high quality polycarbonate lens
- LED license illuminator lens with 6 super bright white LEDs
- Features sequential function with selector switch to control sequential function off/on
- Also features brake attention option with sequence-once function
- Recommend to upgrade under dash flasher to item # 90652 or 90649 LED flasher

Item Number	LEDs	Lens	Application	Pack
<b>110110</b>	Red/White	Red	Driver	1 Pc./Card
<b>110111</b>	Red	Red	Passenger	1 Pc./Card

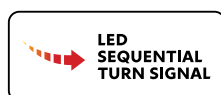

*1937-38 Chevy Passenger Car & 1940-53 Truck*

**LED Tail Light with Blue Dot**

- 27 super bright red LEDs with high quality injection molded polycarbonate lens and center mounted blue dot
- Driver side includes 6 white LED license light
- Epoxy coated, fully sealed electronics
- Solid state circuit boards are designed for 7.7 - 14.0 VDC
- Recommend to upgrade under dash flasher to item # 90652 or 90649 LED flasher

Item Number	LEDs	Lens	Application	Pack
<b>CTL4053LED-LBD</b>	27 Red 6 White	Red	Driver	1 Pc./Box
<b>CTL4053LED-RBD</b>	27 Red	Red	Passenger	1 Pc./Box



*1937-38 Chevy Passenger Car & 1940-53 Truck*

**27 LED Tail Light**

- Super bright LED with high quality injection molded polycarbonate lens
- Features sequential function with selector switch to control sequential function off/on
- Epoxy coated, fully sealed electronics
- Energy efficient solid-state circuit board engineered for 12V DC systems
- LED compatible flasher required for proper operation, item #90652 or 90649
- Features LED license illuminator lens with 6 super bright white LED (left-hand side)
- Set includes L/H #CTL4053LED-L & #CTL4053LED-R pair pre-packed in one box for shipping

Item Number	LEDs	Lens	Application	Pack
<b>111121</b>	Red/White	Red	Driver & Passenger	1 Pair
<b>CTL4053LED-L</b>	Red/White	Red	Driver w/ License	1 Pc./Card
<b>CTL4053LED-R</b>	45 Red	Red	Passenger	1 Pc./Card



*1937-38 Chevy Passenger Car*

**LED Tail Light - Passenger Side**

- 6 super bright white LEDs, complete with polycarbonate lens
- Epoxy coated, fully sealed electronics
- Epoxy coated, fully sealed electronics
- Solid state circuit boards are designed for 7.7 - 14.0 VDC

Item Number	LEDs	Lens	Application	Pack
<b>CTL4053LL</b>	6 White	Clear	Passenger	1 Pc./Card





*1939 Chevy Passenger Car*

**17 LED Red Tail Light**

- 17 super bright red LEDs, complete with polycarbonate lens
- Epoxy coated, fully sealed electronics, 1157 plug
- Energy efficient solid state circuit board for 12VDC systems
- Recommend to upgrade under dash flasher to item # 90652 or 90649 LED flasher
- Mounting pad sold separately: Item # CTL3918-1

Item Number	LEDs	Lens	Pack
<b>CTL3918LED</b>	17 Red	Red	1 Pc./Card



*1939 Chevy Passenger Car*

**17 LED Amber Parking Light**

- 17 super bright LED amber parking light with polycarbonate lens
- Epoxy coated, fully sealed electronics
- Easy wiring with hard wired 1157 double contact plug
- Energy efficient solid-state circuit board for 12V DC systems

Item Number	LEDs	Lens	Package	Pack
<b>CPL3901AB</b>	17 Amber	Amber	Carded	1 Pc./Card



*1939 Chevy Passenger Car*

**17 Red LED Vintage Style Round Tail Light**

- 17 super bright red LEDs, for tail light/stop light/turn signal
- Flush mount design with mounting studs
- Mounting studs are approximately 2-3/4" apart
- 3 wires (hard wired)
- Recommend to upgrade under dash flasher to item # 90652 or 90649 LED flasher
- Mounting pad sold separately: Item # CTL3918-1

Item Number	LEDs	Lens	Pack
<b>CTL3911LED</b>	17 Red	Red	1 Pc./Card



*1939 Chevy Passenger Car*

**17 Amber LED Vintage Style Round Parking Light**

- 17 super bright amber LEDs for P/T/C
- Flush mount design with mounting studs
- Mounting studs are approximately 2-3/4" apart
- 3 wires (hard wired)
- Recommend to upgrade under dash flasher to item # 90652 or 90649 LED flasher
- Mounting pad sold separately: Item # CTL3918-1

Item Number	LEDs	Lens	Pack
<b>CPL3911A</b>	17 Amber	Amber	1 Pc./Card



**LED LIGHTS**  
**1940's CHEVY**

*1940 Chevy Passenger Car*

**22 LED Tail Light**

- 22 super bright red LEDs with high quality polycarbonate lens
- Epoxy coated, fully sealed electronics
- Energy efficient solid-state circuit board for 12V DC systems
- Recommend to upgrade under dash flasher to item # 90652 or 90649 LED flasher

Item Number	LEDs	Lens	Pack
<b>CTL4010LED</b>	22 Red	Red	1 Pc./Card



*1940 Chevy Passenger Car*

**22 LED Tail Light With Chrome Rim**

- 22 super bright red LEDs, with high quality polycarbonate lens
- Includes chrome rim, black housing, socket, bulb, and hardware
- Epoxy coated, fully sealed electronics
- Energy efficient solid-state circuit board for 12V DC systems
- Recommend to upgrade under dash flasher to item # 90652 or 90649 LED flasher

Item Number	LEDs	Lens	Pack
<b>CTL4010LED-AS</b>	22 Red	Red	1 Pc./Card



*1941-48 Chevy Passenger Car*

**39 LED Tail Light**

- 39 super bright red LEDs with high quality polycarbonate lens
- Epoxy coated, fully sealed electronics, 1157 plug
- Energy efficient solid-state circuit board engineered for 12VDC systems
- Recommend to upgrade under dash flasher to item # 90652 or 90649 LED flasher

Item Number	LEDs	Lens	Pack
<b>CTL4248LED</b>	39 Red	Red	1 Pc./Card

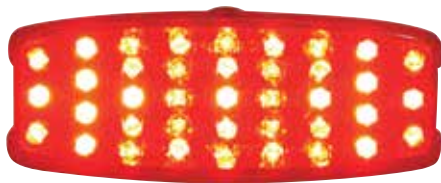

*1941-48 Chevy Passenger Car*

**39 LED Tail Light Assembly**

- 39 super bright red LEDs, complete with polycarbonate lens
- Epoxy coated, fully sealed electronics, 1157 plug
- Stainless steel rim, black housing, rubber mounting pad included
- Mounting pad sold separately: Item # C4003-2

Item Number	LEDs	Lens	Application	Pack
<b>C4061RL</b>	39 Red	Red	Driver	1 Pc./Box
<b>C4062CR</b>	39 Red	Clear	Passenger	1 Pc./Box



*1941-48 Chevy Passenger Car*

**39 LED Tail Light With Flush Mount Bezel**

- 39 super bright red LEDs, flush mount light with polycarbonate lens
- Epoxy coated, fully sealed electronics
- Includes chrome die cast flush mount bezel and rubber mounting pad
- Chrome bezel available separately: item # CTL4248R

Item Number	LEDs	Lens	Pack
<b>CTL424803</b>	39 Red	Red	1 Pc./Card
<b>CTL424804</b>	39 Red	Clear	1 Pc./Card



*1941-48 Chevy Passenger Car*

**39 LED Tail Light with LED Blue Dot**

- 39 super bright LEDs with polycarbonate lens
- Blue dot with chrome plated rim looks exactly like original
- Dual function with tail light & bright stop/turn signal
- Blue dot can be controlled independently with additional wiring
- Easy electrical connection with 1157 plug, no modification to vehicle
- Recommend to upgrade under dash flasher to item # 90652 or 90649 LED flasher

Item Number	LEDs	Lens	Pack
<b>CTL4248LEDBD</b>	39 Red	Red	1 Pc./Card



*1941-48 Chevy Passenger Car*

**36 LED Tail Light Assembly with Blue Dot**

- 36 super bright red LED tail light with stainless steel rim and LED blue dot
- Epoxy coated, fully sealed electronics
- Stainless steel rim, black housing and mounting pad included
- Blue dot with chrome plated rim looks exactly as original
- Blue dot can be controlled independently with additional wiring
- Recommend to upgrade under dash flasher to item # 90652 or 90649 LED flasher

Item Number	LEDs	Application	Pack
<b>C4061RLBD</b>	36 Red	Driver	1 Pc./Box
<b>C4062RRBD</b>	36 Red	Passenger	1 Pc./Box



*1941-48 Chevy Passenger Car*

**LED Tail Light with Blue Dot - Flush Mount**

- 36 super bright red LED tail light with chrome bezel and LED blue dot
- Epoxy coated, fully sealed electronics
- Chrome die cast bezel with rubber mounting pad included
- Blue dot with chrome plated rim looks exactly as original
- Blue dot can be controlled independently with additional wiring
- Recommend to upgrade under dash flasher to item # 90652 or 90649 LED flasher

Item Number	LEDs	Blue Dot	Pack
<b>CTL424805</b>	36 Red	Yes	1 Pc./Card





*1949-50 Chevy Passenger Car*

**16 LED Tail Light Assembly**

- 16 super bright red LEDs, complete with polycarbonate lens
- Epoxy coated, fully sealed electronics, stamped stainless steel rim
- Includes housing, mounting hardware, round reflector, socket, wires
- Mounting pad available separately: Item # C495004
- Recommend to upgrade under dash flasher to item # 90652 or 90649 LED flasher

Item Number	LEDs	Application	Pack
<b>CTL4950LED-ALS</b>	16 Red	Driver	1 Pc./Box
<b>CTL4950LED-ARS</b>	16 Red	Passenger	1 Pc./Box



*1949-50 Chevy Passenger Car*

**16 LED Tail Light**

- 16 super bright red LEDs, complete with polycarbonate lens
- Epoxy coated, fully sealed electronics, 1157 plug
- Energy efficient solid-state circuit board engineered for 12VDC
- Recommend to upgrade under dash flasher to item # 90652 or 90649 LED flasher

Item Number	LEDs	Lens	Pack
<b>CTL4901LED</b>	16 Red	Red	1 Pc./Card



*1949-50 Chevy Passenger Car*

**Tail Light Mounting Pad**

- High durability foam rubber material
- Exact shape and size as original to provide a tight seal
- Sold in pairs

Item Number	Description	Pack
<b>C495004</b>	Mounting Pad	1 Pair



**2** SOLD IN PAIRS

1951-52 Chevy Passenger Car

**16 LED Tail Light Assembly With Chrome Housing**

- 16 super bright red LED with high quality polycarbonate lens
- Beautiful chrome plated housing with show ready chrome zinc die-cast bezel
- Includes chrome housing, mounting hardware, round reflector, socket and wires
- Mounting hardware, round reflector, socket and wiring included
- Recommend to upgrade under dash flasher to item # 90652 or 90649 LED flasher

Item Number	LEDs	Lens	Pack
CTL5152LED-AS	16 Red	Red	1 Pc./Box



1951-52 Chevy Passenger Car

**16 LED Tail Light**

- 16 super bright red LED's with high quality polycarbonate lens
- Epoxy coated, fully sealed electronics, 1157 plug
- Energy efficient solid-state circuit board for 12VDC systems
- Recommend to upgrade under dash flasher to item # 90652 or 90649 LED flasher

Item Number	LEDs	Lens	Pack
CTL5152LED	16 Red	Red	1 Pc./Card



1951-52 & 1956 Chevy Passenger Car

**5 LED Tail Light Reflector**

- 5 super bright LED's with high quality polycarbonate lens
- Mounting stud and nut included
- Mounting pad sold separately: Item # CTL5606P
- Recommend to upgrade under dash flasher to item # 90652 or 90649 LED flasher

Item Number	LEDs	Lens	Pack
CTL5606LED	5 Red	Red	1 Pc.
CTL5606A	5 Amber	Amber	1 Pc.
CTL5606W	5 White	White	1 Pc.

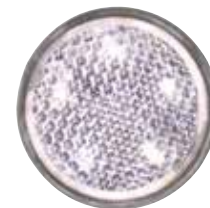
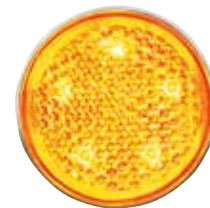
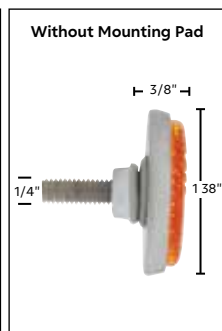

**LED LIGHTS**  
**1950's CHEVY**

*1953 Chevy Passenger Car*

**26 LED Tail Light**

- 26 super bright LEDs with quality polycarbonate lens
- Epoxy coated, fully sealed electronics
- Energy efficient solid-state circuit board for 12VDC systems
- Recommend to upgrade under dash flasher to item # 90652 or 90649 LED flasher

Item Number	LEDs	Lens	Pack
<b>CTL5310</b>	26 Red	Red	1 Pc./Card



*1953 Chevy Passenger Car*

**40 LED Tail Light**

- 40 super bright LEDs with high quality polycarbonate lens
- Stop/tail/turn function
- Epoxy coated, fully sealed electronics
- Energy efficient solid-state circuit board for 12VDC systems
- Recommend to upgrade under dash flasher to item # 90652 or 90649 LED flasher

Item Number	LEDs	Lens	Pack
<b>CTL5312</b>	40 Red	Red	1 Pc./Card



*1953 Chevy Passenger Car*

**26 LED Backup Light**

- 26 super bright clear LEDs with clear lens
- High quality injection molded polycarbonate lens
- Epoxy coated, fully sealed electronics
- Energy efficient solid-state circuit board for 12V DC systems

Item Number	LEDs	Lens	Pack
<b>CBL5311</b>	26 White	Clear	1 Pc./Card



*1954 Chevy Passenger Car*

**40 LED Tail Light**

- 40 super bright red LEDs with high quality polycarbonate lens
- Epoxy coated, fully sealed electronics, 1157 plug
- Energy efficient solid-state circuit board for 12V DC systems
- Recommend to upgrade under dash flasher to item # 90652 or 90649 LED flasher

Item Number	LEDs	Lens	Pack
<b>CTL5401LED</b>	40 Red	Red	1 Pc./Card

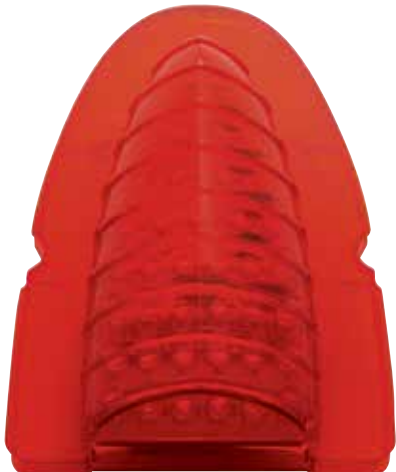

*1954 Chevy Passenger Car*

**28 LED Back-Up Light**

- 28 super bright LEDs with high quality polycarbonate lens
- Epoxy coated, fully sealed electronics, 1156 plug
- Energy efficient solid-state circuit board for 12V DC systems
- Recommend to upgrade under dash flasher to item # 90652 or 90649 LED flasher

Item Number	LEDs	Lens	Pack
<b>CBL5451LED</b>	28 Red	Clear	1 Pc./Card



*1954 Chevy Passenger Car*

**40 LED Tail Light Assembly**

- 40 LED tail light with chrome bezel, all lenses, gaskets, and backing plate
- Includes 28 LED backup lens
- 12V, includes tail light socket & backup light socket
- Mounting hardware and body seal included
- Epoxy coated, fully sealed electronics
- Recommend to upgrade under dash flasher to item # 90652 or 90649 LED flasher

Item Number	LEDs	Lens	Pack
<b>CTL5408LED</b>	40 Red/28White	Red/Clear	1 Pc./Box

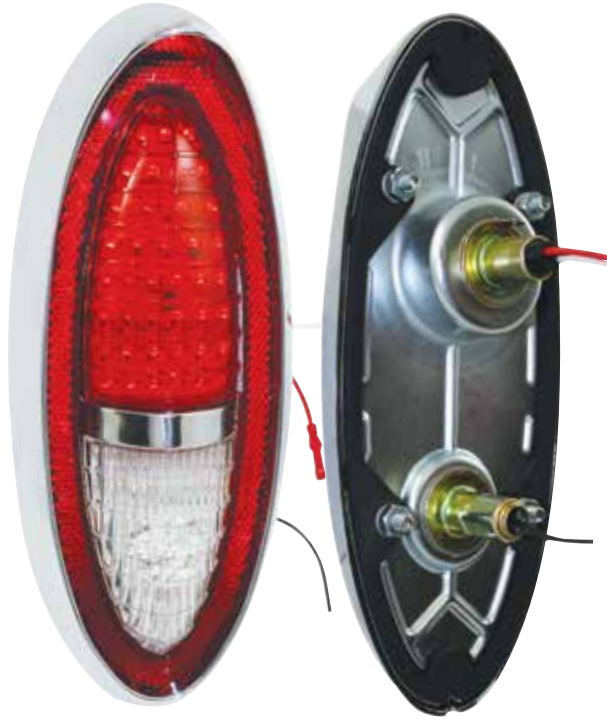

*1955 Chevy Passenger Car*

**37 LED Parking and Turn Signal Light**

- 37 super bright LEDs with high quality polycarbonate lens
- Epoxy coated, fully sealed electronics, 1157 plug
- Solid state circuit boards are designed for 7.7 - 14.0 VDC

Item Number	LEDs	Lens	Pack
<b>CPL5531A</b>	37 Amber	Amber	1 Pc./Card
<b>CPL5531C</b>	37 Amber	Clear	1 Pc./Card



*1955 Chevy Passenger Car*

**37 LED Sequential Parking Light**

- Super bright amber LED with high quality injection molded acrylic lens
- Features sequential function with selector switch to control sequential function off/on
- Epoxy coated, fully sealed electronics
- Easy electrical connection with 1157 plug, no modification to vehicle
- Energy efficient solid-state circuit board engineered for 12V DC systems
- Lens gasket sold separately item #C5536
- Recommend to upgrade under dash flasher to item #90652 or 90649 LED flasher
- Selector switch positions: up=sequence left to right, center=sequential function off, down=sequence right to left

Item Number	LEDs	Lens	Pack
<b>111036</b>	37 Amber	Amber	1 Pc./Card
<b>111037</b>	37 Amber	Clear	1 Pc./Card

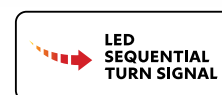

**LED LIGHTS**  
**1950's CHEVY**

1955 Chevy Passenger Car

**48 LED Sequential One-Piece Style Tail Light**

- 48 SMD LED sequential tail light w/ high quality polycarbonate lens
- Features sequential function with selector switch to control sequential function off, direction left, or direction right
- Also features brake attention option with sequence-once function
- Epoxy coated, fully sealed electronics, 1157 plug
- Energy efficient solid-state circuit board for 12V DC systems
- Recommend to upgrade under dash flasher to item # 90652 or 90649 LED flasher
- Recommend license plate with LED back-up light, item # 50187

Item Number	LED	Lens	Application	Pack
110207	48 Red	Red	Tail Light	1 Pc./Card



1955 Chevy Passenger Car

**48 LED One-Piece Style Tail Light**

- 48 SMD super bright red LEDs with high quality polycarbonate lens
- Direct plug & play installation with 1157 type connector
- Epoxy coated, fully sealed electronics, 1157 plug
- Energy efficient solid-state circuit board for 12V DC systems
- Recommend to upgrade under dash flasher to item # 90652 or 90649 LED flasher
- Recommend license plate with LED back-up light, item # 50187

Item Number	LED	Lens	Application	Pack
110206	48 Red	Red	Tail Light	1 Pc./Card



1955 Chevy Passenger Car

**60 LED Tail Light**

- 60 super bright red LEDs with high quality polycarbonate lens
- Epoxy coated, fully sealed electronics, 1157 plug
- Energy efficient solid-state circuit board for 12V DC systems
- Recommend to upgrade under dash flasher to item # 90652 or 90649 LED flasher

Item Number	LEDs	Lens	Pack
CTL5510LED	60 Red	Red	1 Pc./Card



1955 Chevy Passenger Car

**26 LED Backup Light**

- 26 super bright white LEDs with high quality polycarbonate lens
- Epoxy coated, fully sealed electronics, 1156 plug
- Energy efficient solid-state circuit board for 12V DC systems

Item Number	LEDs	Lens	Pack
CBL5511LED	26 White	Clear	1 Pc./Card





*1957 Chevy Passenger Car*

**32 LED Sequential Tail Light**

- 32 super bright red LEDs with high quality polycarbonate lens
- Selector switch controls sequential function off, left, direction right
- Also features brake attention option with sequence-once function
- Epoxy coated, fully sealed electronics, 1157 plug
- Requires to upgrade under dash flasher to item # 90652 or 90649 LED flasher
- DOT & SAE FMVSS108

Item Number	LED	Lens	Application	Pack
110198	32 Red	Red	Tail Light	1 Pc./Card



*1957 Chevy Passenger Car*

**51 LED Tail Light**

- 51 super bright red LEDs with high quality polycarbonate lens
- Epoxy coated, fully sealed electronics, 1157 plug
- Energy efficient solid-state circuit board for 12V DC systems
- Recommend to upgrade under dash flasher to item # 90652 or 90649 LED flasher

Item Number	LEDs	Lens	Pack
CTL5720LED	51 Red	Red	1 Pc./Card

**LED LIGHTS**  
**1950's CHEVY**

1956 Chevy Passenger Car

**40 LED Tail Light**

- 40 super bright LEDs with high quality polycarbonate lens
- Epoxy coated, fully sealed electronics
- Energy efficient solid-state circuit board for 12V DC systems
- Recommend to upgrade under dash flasher to item # 90652 or 90649 LED flasher
- Due to space restriction, wires must be connected with included quick splice terminals

Item Number	LEDs	Lens	Pack
<b>CTL5608LED</b>	40 Red	Red	1 Pc./Card



1956 Chevy Passenger Car

**26 LED Backup Light Lens**

- 26 Super bright white LEDs with high quality polycarbonate lens
- Epoxy coated, fully sealed electronics

Item Number	LEDs	Lens	Application	Pack
<b>CBL5607LED</b>	26 White	Clear	Backup Light	1 Pc./Card



1956 Chevy Passenger Car

**35 LED Parking Light**

- 35 super bright amber LEDs with high quality polycarbonate lens
- Epoxy coated, fully sealed electronics, 1157 plug
- Energy efficient solid-state circuit board for 12V DC systems

Item Number	LEDs	Lens	Pack
<b>CPL5601C</b>	35 Amber	Clear	1 Pc./Card

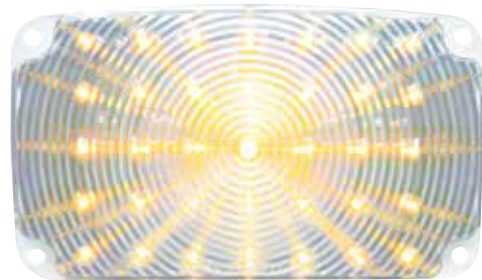

1957 Chevy Car

**17 LED Parking and Turn Signal Light**

- 17 super bright LEDs with high quality polycarbonate lens
- Dual function with parking light & bright turn signal
- Epoxy coated, fully sealed electronics, 1157 plug
- Solid state circuit boards are designed for 7.7 - 14.0 VDC

Item Number	LEDs	Lens	Pack
<b>CPL5702A</b>	17 Amber	Amber	1 Pc./Card
<b>CPL5702C</b>	17 Amber	Clear	1 Pc./Card



1957 Chevy Passenger Car

**28 LED Backup Light**

- 28 super bright white LEDs with high quality polycarbonate lens
- Epoxy coated, fully sealed electronics, 1156 plug
- Lifetime warranty

Item Number	LEDs	Lens	Application	Pack
<b>110221</b>	28 White	Clear	Backup Light	1 Pc./Card



1955-60 Chevy Car

**24 LED Dome Light**

- 24 super bright white LEDs with high quality polycarbonate lens
- Beautiful chrome bezel with housing, whit lens, LED, and wires
- Does not fit 1955 Hardtop or Nomad

Item Number	LEDs	Lens	Pack
<b>CDL555701-AS</b>	24 White	Clear	1 Pc./Box



1955-60 Chevy Car

**24 LED Dome Light Conversion**

- 24 super bright white LEDs with high quality polycarbonate lens
- Simply installs in place of light bulb, connects with 1156 plug
- Does not fit 1955 Hardtop or Nomad

Item Number	LEDs	Lens	Pack
<b>CDL555701</b>	24 White	Clear	1 Pc./Card



**LED LIGHTS**  
**1950's CHEVY**

1959 Cadillac

**40 LED Tail Light**

- 40 super bright LEDs with high quality polycarbonate lens
- Epoxy coated, fully sealed electronics
- 3 wires (1 wire with ring terminal)
- Energy efficient solid-state circuit board for 12V DC systems

Item Number	LEDs	Lens	Pack
CTL5901LED	40 Red	Red	1 Pc./Card

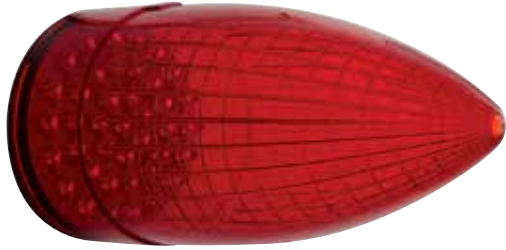

1959 Cadillac

**40 LED Tail Light Assembly**

- 40 super bright LEDs with high quality polycarbonate lens
- Includes chrome die cast bezel with mounting base
- Epoxy coated, fully sealed electronics
- 3 wires (1 wire with ring terminal)

Item Number	LEDs	Lens	Pack
CTL5911LED	40 Red	Red	1 Pc./Card



1959 Cadillac

**40 LED Tail Light - Flush Mount**

- 40 LED Tail Light with chrome die cast flush mount bezel
- Easy surface mounting with 2 studs
- Rubber mounting pad available separately: Item # CTL5903-1
- 12V, completely water proof
- Recommend to upgrade under dash flasher to item # 90652 or 90649 LED flasher

Item Number	LEDs	Lens	Pack
CTL5913LED	40 Red	Red	1 Pc./Box



1959 Cadillac

**Flush Mount Bezel**

- Flush mount bezel for 1959 Cadillac LED Tail Light
- Mounting studs are approximately 3 1/4" apart

Item Number	Description	Pack
CTL5903R	Flush Mount Bezel	1 Pc./Box

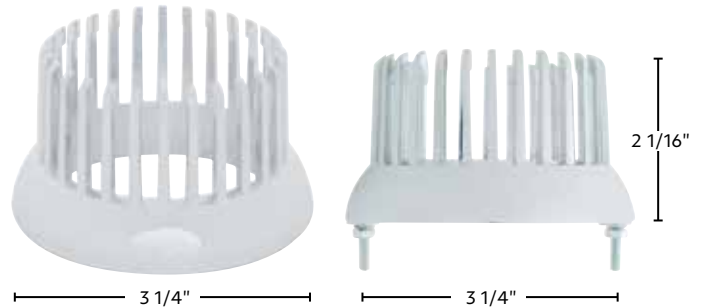

1959 Cadillac

**Flush Mount Rubber Pad**

- Flush mount rubber pad for 1959 Cadillac flush mount bezel

Item Number	Description	Pack
CTL5903-1	Mounting Pad Only	1 Pc.



1958 Chevy Impala

**39 LED Parking Light Lens**

- 39 super bright LED with high quality polycarbonate lens
- New lens is the same size & shape as the original Impala lens
- Dual function with parking light & bright turn signal
- Easy wiring with hard wired 1157 double contact plug
- Recommend to upgrade under dash flasher to item #90652 or 90649
- Hot tip: this LED can be used in place of the dummy lens, 2 LED each

Item Number	LEDs	Lens	Pack
CPL5801A	39 Amber	Amber	1 Pc./Card
CPL5801C	39 Amber	Clear	1 Pc./Card



1959 Chevy Impala

**98 LED Tail Light - Retrofit**

- 98 super bright LEDs, retrofit circuit board only
- Designed to fit 1959 Chevy Impala Tail Light using existing lens
- Epoxy coated, fully sealed electronics, 1157 plug
- Solid state circuit boards are designed for 7.7 - 14.0 VDC
- Fits United Pacific Tail Light lens: Item # C5901L and C5901R

Item Number	LEDs	Lens	Application	Pack
CTL5902LED-L	98 Red	Red	Driver	1 Pc./Card
CTL5902LED-R	98 Red	Clear	Passenger	1 Pc./Card



1958 Chevy Impala

**Parking Light Lens Gasket**

- Grey foam gasket, same as original, each car requires 4 gaskets
- Sold each, fits left hand and right hand side

Item Number	Description	Pack
C5851	Impala Lens Gasket	1 Pc.



1959 Chevy Impala

**Tail Light Lens**

- 1959 Chevy Impala Tail Light lens
- GM restoration licensed product

Item Number	LEDs	Lens	Application	Pack
C5901L	Red	Red	Driver	1 Pc./Bag
C5901R	Red	Red	Passenger	1 Pc./Bag

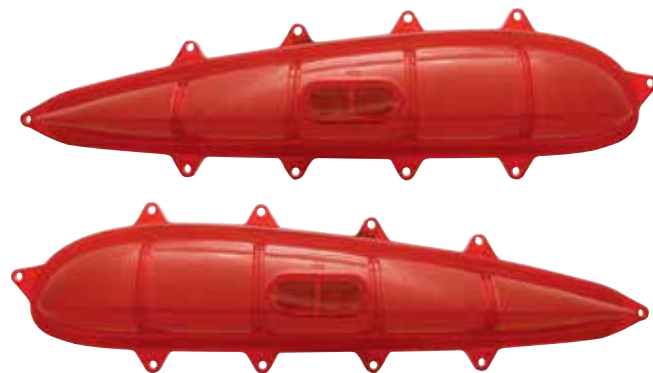

1959 Chevy Impala

**Tail Light Lens Trim Set**

- 8 polished stainless steel trim and 20 shoulder lens screws & nuts
- One set does both tail lamps

Item Number	Description	Pack
C5902	Trim + Nut & Bolt	1 Pair



**2** SOLD IN PAIRS



# C5902 - Trim + Nut & Bolt

**LED LIGHTS**  
**CHEVY CAMARO**





**LED LIGHTS**  
**CHEVY CAMARO**

*1967 Chevy Camaro "Rally Sport"*

**40 LED Tail Light**

- 40 super bright LEDs with high quality polycarbonate lens
- Epoxy coated, fully sealed electronics, 1157 plug
- Energy efficient solid-state circuit board for 12V DC systems
- Recommend upgrading under dash flasher to UP item # 90652 or 90649 LED flasher

Item Number	LEDs	Lens	Application	Pack
<b>CTL6703LED</b>	40 Red	Red	LH & RH	1 Pc./Card



*1967 Chevy Camaro*

**40 LED Stop, Turn & Tail Light With Chrome Bezel**

- 40 LED rectangular S/T/T light with chrome plastic bezel
- Flush mount
- Chrome bezel available separately: Item # 37961

Item Number	LEDs	Lens	Pack
<b>37961</b>	40 Red	Red	1 Pc.



*1968 Chevy Camaro*

**LED Tail Light & Backup Light Lens**

- 48 super bright red LED tail light lens & 20 super bright white LED backup light lens, high quality polycarbonate lens
- Dual function with tail light and bright stop/turn signal
- Epoxy coated, fully sealed electronics, 1157 plug
- Energy efficient solid-state circuit board for 12V DC systems
- Recommend upgrading under dash flasher to UP item # 90652 or 90649 LED flasher

Item Number	LEDs	Lens	Function	Pack
<b>CTL6803LED</b>	48 Red	Red	Tail	1 Pc./Card
<b>CBL6853LED</b>	20 White	Clear	Back-Up	1 Pc./Card

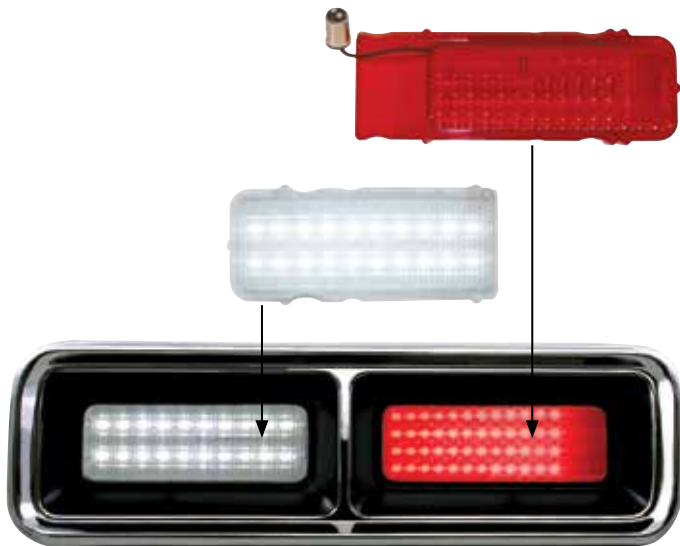

*1968 Chevy Camaro "Rally Sport"*

**48 LED Tail Light - Rally Sport**

- 48 super bright LEDs with high quality polycarbonate lens
- Dual function with tail light & bright stop/turn signal
- Epoxy coated, fully sealed electronics, 1157 plug
- Energy efficient solid-state circuit board for 12V DC systems
- Recommend upgrading under dash flasher to UP item # 90652 or 90649 LED flasher

Item Number	LEDs	Lens	Function	Pack
<b>CTL6805LED</b>	48 Red	Red	Tail	1 Pc./Card
<b>CTL6803LED</b>	48 Red	Red	Tail	1 Pc./Card



*1969 Chevy Camaro "Rally Sport"*

**84 LED Tail Light**

- 84 super bright red LEDs with red polycarbonate lens
- Rally sport style lens with stainless trim, all 3 segments are LED
- Upgrade to sequential function with item # 90656
- Epoxy coated, fully sealed electronics, 1157 plug
- Energy efficient solid-state circuit board for 12V DC systems
- Solid state circuit boards are designed for 7.7 - 14.0 VDC

Item Number	LEDs	Lens	Application	Pack
<b>CTL6901LED-L</b>	84 Red	Red	Driver	1 Pc./Box
<b>CTL6901LED-R</b>	84 Red	Red	Passenger	1 Pc./Box





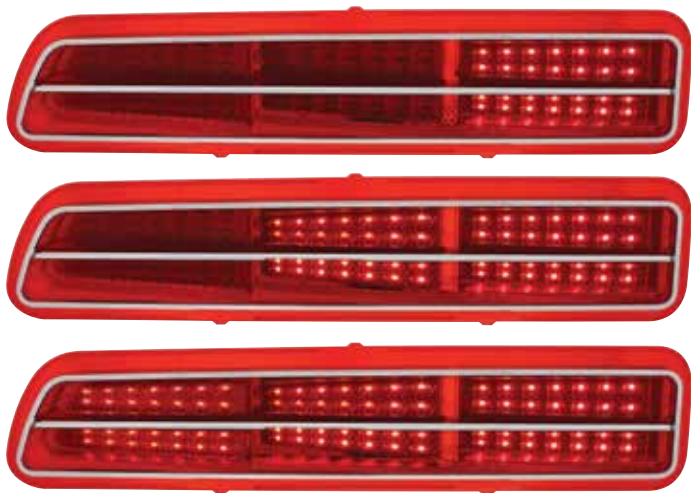

**1969 Chevy Camaro**  
**84 LED Sequential Tail Light**

- Super bright LED, complete with high quality injection molded polycarbonate lens
- Features sequential function with selector switch to control sequential function off/on
- Also features brake attention option with sequence-once function
- Includes polished stainless steel trim ring attached
- Epoxy coated, fully sealed electronics
- Easy electrical connection with 1157 plug, no modification to vehicle
- Energy efficient solid-state circuit board engineered for 12V DC systems
- LED compatible flasher required for proper operation, item #90652 or 90649.
- Lifetime warranty
- Set includes L/H #110108 & R/H #110109 pair pre-packed in one box for shipping

Item Number	LEDs	Lens	Application	Pack
<b>111116</b>	84 Red	Red	Driver & Passenger	1 Pair
<b>110108</b>	84 Red	Red	Driver	1 Pc./Card
<b>110109</b>	84 Red	Red	Passenger	1 Pc./Card

**1967 Chevy Camaro Standard**

**40 LED Tail Light**

- 40 super bright red LEDs with high quality injection molded polycarbonate lens
- Will not fit RS model Camaro
- Energy efficient solid-state circuit board for 12V DC systems
- Recommend to upgrade under dash flasher to item # 90652 or 90649 LED flasher

Item Number	LEDs	Lens	Application	Pack
<b>CTL6704LED</b>	40 Red	Red	Tail Light	1 Pc./Card



**1968 Chevy Camaro**

**48 LED Tail Light Lens**

- 48 super bright red LEDs with high quality injection molded polycarbonate lens
- Epoxy coated, fully sealed electronics
- Easy wiring with hard wired 1157 double contact plug
- Energy efficient solid-state circuit board for 12V DC systems
- Recommend to upgrade under dash flasher to item # 90652 or 90649 LED flasher

Item Number	LEDs	Lens	Application	Pack
<b>CTL6803C</b>	48 Red	Clear	Tail Light	1 Pc./Card



**1967 Chevy Camaro Standard**

**35 LED Backup Light Lens**

- 35 Super bright white LEDs with high quality polycarbonate lens
- Epoxy coated, fully sealed electronics, 1156 plug
- Energy efficient solid-state circuit board for 12V DC systems

Item Number	LEDs	Lens	Application	Pack
<b>CBL6704LED</b>	35 White	Clear	Backup Light	1 Pc./Card



**LED LIGHTS**  
**CHEVY CAMARO**

1968 Chevy Camaro

**20 LED Backup Light Lens**

- 20 super bright white LEDs with high quality polycarbonate lens
- Epoxy coated, fully sealed electronics, 1156 plug
- Energy efficient solid-state circuit board for 12V DC systems

Item Number	LEDs	Lens	Function	Pack
<b>CBL6853LED</b>	20 White	Clear	Back-Up	1 Pc./Card



1970-73 Chevy Camaro

**30 LED Tail Light**

- Super bright red LED with high quality injection molded polycarbonate lens
- Includes polished stainless steel lens trim attached
- Dual function with tail light and bright stop/turn signal
- Fully sealed electronic solid state circuit boards are designed to operate at 12V DC
- LED compatible flasher required for proper operation, item #90652 or 90649
- Set includes L/H #CTL7073LED-L & R/H #CTL7073LED-R pair pre-packed in one box for shipping

Item Number	LEDs	Lens	Application	Pack
<b>111114</b>	30 Red	Red	Driver & Passenger	1 Pair
<b>CTL7073LED-L</b>	30 Red	Red	Driver	1 Pc./Card
<b>CTL7073LED-R</b>	30 Red	Red	Passenger	1 Pc./Card



**2** SOLD IN PAIRS

1969 Camaro "Rally Sport"

**27 LED Backup Light**

- 27 super bright white LEDs with high quality polycarbonate lens
- Epoxy coated, fully sealed electronics, 1156 plug
- Energy efficient solid-state circuit board for 12V DC systems
- Fits L/H or R/H side

Item Number	LEDs	Lens	Application	Pack
<b>110443</b>	27 White	Clear	Backup Light	1 Pc./Card



1970-73 Chevy Camaro

**30 LED Backup Light**

- 30 super bright white LED center backup light with 18 additional dual function red LED light
- Features polished stainless steel lens trim with high quality polycarbonate lens
- Additional red LEDs are designed for tail/stop/turn signal light use (quick splice connectors included)
- Fully sealed electronic solid state circuit boards are designed to operate at 12V DC
- Direct plug-n-play to original wiring harness with 1156 plug

Item Number	LEDs	Lens	Application	Pack
<b>110375</b>	30 Red/18White	Red	Driver	1 Pc./Card
<b>110376</b>	30 Red/18White	Red	Passenger	1 Pc./Card



1965 Chevy Chevelle & Malibu

**41 LED Tail Light**

- Super bright red LED with high quality injection molded polycarbonate lens
- Highly polished stainless steel trim
- Easy electrical connection with 1157 plug, no modification to vehicle
- Energy efficient solid-state circuit board engineered for 12V DC systems
- LED compatible flasher required for proper operation, item #90652 or 90649
- Lifetime warranty
- Set includes L/H #CTL6521LED-L & R/H #CTL6521LED-R pair pre-packed in one box for shipping

Item Number	LEDs	Lens	Application	Pack
<b>111118</b>	41 Red	Red	Driver	1 Pair
<b>CTL6521LED-L</b>	41 Red	Red	Driver	1 Pc./Card
<b>CTL6521LED-R</b>	41 Red	Red	Passenger	1 Pc./Card



**2** SOLD IN PAIRS

1964 Chevy Chevelle

**23 LED Tail Light Lens**

- Super bright red LED with high quality injection molded polycarbonate lens
- Dual function with tail light & bright stop/turn signal
- Epoxy coated, fully sealed electronics, 1157 plug
- LED compatible flasher required for proper operation, item #90652 or 90649
- Set includes L/H #CTL6402LED-L & R/H #CTL6402LED-R pair pre-packed in one box for shipping

Item Number	LEDs	Lens	Application	Pack
<b>111123</b>	23 Red	Red	Driver & Passenger	1 Pair
<b>CTL6402LED-L</b>	23 Red	Red	Driver	1 Pc./Card
<b>CTL6402LED-R</b>	23 Red	Red	Passenger	1 Pc./Card



**2** SOLD IN PAIRS

1967 Chevy Chevelle

**68 LED Tail Light**

- 68 super bright LEDs with high quality polycarbonate lens
- Epoxy coated, fully sealed electronics, 1157 plug
- Energy efficient solid-state circuit board for 12V DC systems
- Recommend upgrading under dash flasher to UP item # 90652 or 90649 LED flasher

Item Number	LEDs	Lens	Function	Pack
<b>CTL6701LED</b>	68 Red	Red	Tail Light	1 Pc./Card
<b>CTL6701C</b>	68 Red	Clear	Tail Light	1 Pc./Card



**LED LIGHTS**  
**CHEVY CHEVELLE/MALIBU**

*1970 Chevy Chevelle*

**48 LED Sequential Tail Light Insert Boards**

- 48 super bright red LED tail light insert board
- Features sequential function with selector switch to control sequential function off/on
- Also features brake attention option with sequence-once function
- Epoxy coated, fully sealed electronics, 1157 plug
- Energy efficient solid-state circuit board for 12V DC systems
- LED compatible flasher required for proper operation, item #90652 or 90649
- Set includes L/H #110157 & R/H #110158 pair pre-packed in one box for shipping

Item Number	LEDs	Sequential	Application	Pack
111122	48 Red	Sequential	Pair	1 Pair
110157	48 Red	Sequential	Driver	1 Pc./Card
110158	48 Red	Sequential	Passenger	1 Pc./Card

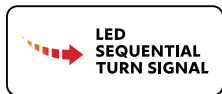
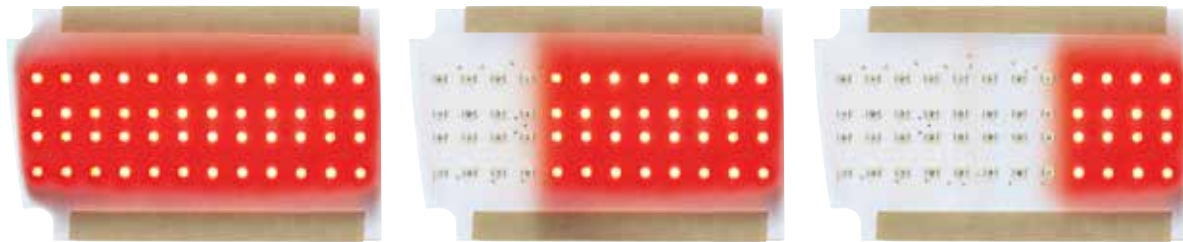

*1970 Chevy Chevelle*

**48 LED Non-Sequential Tail Light Insert Boards**

- 48 super bright red LED tail light insert board
- Epoxy coated, fully sealed electronics
- Easy electrical connection with 1157 plug, no modification to vehicle
- Energy efficient solid-state circuit board engineered for 12V DC systems

Item Number	LEDs	Sequential	Application	Pack
110155	48 Red	Non-Sequential	Driver	1 Pc./Card
110156	48 Red	Non-Sequential	Passenger	1 Pc./Card

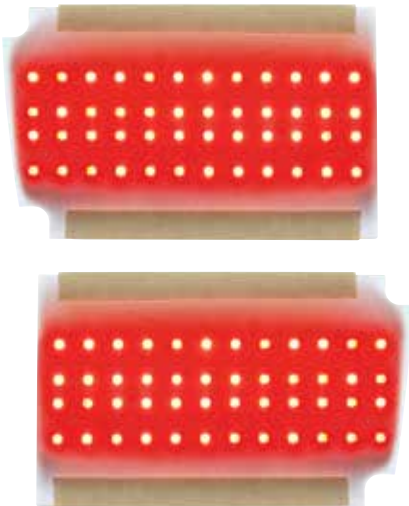

*1968 Chevy Chevelle*

**52 LED Tail Light**

- Super bright red LED with high quality injection molded polycarbonate lens
- Epoxy coated, fully sealed electronics
- Easy electrical connection with 1157 plug, no modification to vehicle
- LED compatible flasher required for proper operation, item #90652 or 90649
- Set includes L/H #CTL6821LED-L & R/H #CTL6821LED-R pair pre-packed in one box for shipping

Item Number	LEDs	Lens	Application	Pack
111115	50 Red	Red	Driver & Passenger	1 Pair
CTL6821LED-L	50 Red	Red	Driver	1 Pc./Card
CTL6821LED-R	50 Red	Red	Passenger	1 Pc./Card



1971 Chevy Chevelle SS & Malibu

**46 LED Tail Light Lens With Stainless Steel Trim**

- 46 super bright red LED tail light with polycarbonate lens and stainless steel trim
- Dual function with tail light and bright stop/turn signal
- Epoxy coated, fully sealed electronics
- Easy wiring with hard wired 1157 double contact plug
- Recommend to upgrade under dash flasher to item # 90652 or 90649 LED flasher
- Lifetime warranty

Item Number	LEDs	Lens	Application	Pack
CTL7101LED-L	46 Red	Red	Driver	1 Pc./Card
CTL7101LED-R	46 Red	Red	Passenger	1 Pc./Card



1972 Chevy Chevelle SS & Malibu

**42 LED Tail Light Lens With Stainless Steel Trim**

- 42 super bright red LED tail light with polycarbonate lens and stainless steel trim
- Dual function with tail light and bright stop/turn signal
- Epoxy coated, fully sealed electronics
- Easy wiring with hard wired 1157 double contact plug
- Recommend to upgrade under dash flasher to item # 90652 or 90649 LED flasher

Item Number	LEDs	Lens	Application	Pack
111119	42 Red	Red	Driver & Passenger	1 Pair
CTL7201LED-L	42 Red	Red	Driver	1 Pc./Card
CTL7201LED-R	42 Red	Red	Passenger	1 Pc./Card



**2** SOLD IN PAIRS

1972 Chevy Chevelle SS & Malibu

**34 White LED Backup Light**

- Super bright white LED with high quality injection molded polycarbonate lens
- Complete with stainless steel trim
- Epoxy coated, fully sealed electronics
- Easy electrical connection with 1156 plug, no wiring modification to vehicle is required
- Lifetime warranty

Item Number	LEDs	Lens	Application	Pack
111127	34 White	Red/Clear	Driver & Passenger	1 Pair
CBL7201LED-L	34 White	Red/Clear	Driver	1 Pc./Card
CBL7201LED-R	34 White	Red/Clear	Passenger	1 Pc./Card



**2** SOLD IN PAIRS



1971 Chevy Chevelle SS & Malibu

**21 LED Backup Light**

- 21 super bright white LEDs with high quality polycarbonate lens and stainless steel trim
- Epoxy coated, fully sealed electronics, 1156 plug
- Lifetime warranty

Item Number	LEDs	Lens	Application	Pack
CBL7101LED-L	21 White	Red/Clear	Driver	1 Pc./Card
CBL7101LED-R	21 White	Red/Clear	Passenger	1 Pc./Card



**LED LIGHTS**  
**CHEVY CORVETTE**

*1963-66 Chevy Corvette*

**20 LED Backup Light**

- 20 super bright white LEDs, complete with polycarbonate lens
- Epoxy coated, fully sealed electronics, 1156 plug
- Energy efficient solid-state circuit board for 12V DC systems

Item Number	LEDs	Lens	Application	Pack
<b>CBL6366LED</b>	20 White	Clear	Back-Up	1 Pc./Card



*1967 Chevy Corvette*

**20 LED Backup Light Lens**

- 20 super bright white LEDs, complete with polycarbonate lens
- Epoxy coated, fully sealed electronics, 1156 plug
- Energy efficient solid-state circuit board for 12V DC systems

Item Number	LEDs	Lens	Application	Pack
<b>CBL6711LED</b>	20 White	Clear	Driver	1 Pc./Card
<b>CBL6712LED</b>	20 White	Clear	Passenger	1 Pc./Card



*1968-73 Chevy Corvette*

**17 LED Tail Light With Stainless Steel Trim**

- 17 super bright red LEDs, complete with polycarbonate lens and stainless steel trim
- Epoxy coated, fully sealed electronics, 1157 plug
- Solid state circuit boards are designed for 7.7 - 14.0 VDC
- Recommend upgrading under dash flasher to UP item # 90652 or 90649 LED flasher

Item Number	LEDs	Lens	Application	Pack
<b>CTL6804LED</b>	17 Red	Red	Tail Light	1 Pc./Card



*1968-73 Chevy Corvette*

**20 LED Backup Light**

- 20 super bright white LEDs, complete with polycarbonate lens and stainless steel trim
- Epoxy coated, fully sealed electronics, 1156 plug
- Energy efficient solid-state circuit board for 12V DC systems

Item Number	LEDs	Lens	Application	Pack
<b>CBL6951LED</b>	20 White	Red/Clear	Back-Up	1 Pc./Card



1990-96 Chevy Corvette

**30 LED Tail Light**

- 30 super bright white LEDs with high quality polycarbonate lens
- Epoxy coated, fully sealed electronics, 1157 plug
- Energy efficient solid-state circuit board for 12V DC systems
- Recommend to upgrade under dash flasher to item # 90652 or 90649 LED flasher

Item Number	LEDs	Lens	Application	Pack
<b>CTL9096LED</b>	30 Red	Red	Tail light	1 Pc./Card



1980-82 Chevy Corvette

**19 Chevy Corvette LED Tail Light**

- 19 super bright red LEDs, complete with polycarbonate lens
- Most Corvette customers install 4 per car (use 50121 back-up light)
- Epoxy coated, fully sealed electronics, 1157 plug
- Energy efficient solid-state circuit board for 12V DC systems
- Will fit 1975-79 note: must trim plastic mounting legs to match 1975-79 size
- Recommend to upgrade under dash flasher to item # 90652 or 90649 LED flasher

Item Number	LEDs	Lens	Application	Pack
<b>CTL8010LED</b>	19 Red	Red	Tail Light	1 Pc./Card
<b>CTL8010C</b>	19 Red	Clear	Tail Light	1 Pc./Card



1975-82 Chevy Corvette

**25 LED Bubble Style Tail Light**

- 25 super bright red LEDs complete with polycarbonate lens
- Most corvette customers install four per car (use 50121 back-up light)
- Epoxy coated, fully sealed electronics, 1157 plug
- Energy efficient solid-state circuit board for 12V DC systems
- 1975-79 note: must trim plastic mounting legs to match 1975-79 size
- Recommend to upgrade under dash flasher to item # 90652 or 90649 LED flasher

Item Number	LEDs	Lens	Application	Pack
<b>CTL7582LED</b>	25 Red	Red	Tail Light	1 Pc./Card



1984-90 Chevy Corvette

**19 LED Tail Light**

- 19 super bright red LEDs with high quality polycarbonate lens
- Epoxy coated, fully sealed electronics, 1157 plug
- Energy efficient solid-state circuit board for 12V DC systems
- Recommend to upgrade under dash flasher to item # 90652 or 90649 LED flasher

Item Number	LEDs	Lens	Application	Pack
<b>CTL8490LED</b>	19 Red	Red	Tail Light	1 Pc./Card



**LED LIGHTS**  
**CHEVY CORVETTE**

*1956-57 Chevy Corvette*

**15 LED Tail Light**

- 15 super bright red LEDs with high quality polycarbonate lens
- Epoxy coated, fully sealed electronics
- Easy wiring with hard wired 1157 double contact plug, 12V only
- Recommend to upgrade to under dash flasher to item #90652 or 90649 LED flasher

Item Number	LEDs	Lens	Application	Pack
CTL5701LED	15 Red	Red	Tail light	1 Pc./Card



*1958-67 Chevy Corvette*

*1958-60 Passenger Car*

**13 LED Tail Light Lens**

- 13 super bright red LEDs with high quality polycarbonate lens
- Epoxy coated, fully sealed electronics, 1157 plug
- Energy efficient solid-state circuit board for 12V DC systems
- Recommend to upgrade to under dash flasher to item #90652 or 90649 LED flasher

Item Number	LEDs	Lens	Application	Pack
CTL5860LED	15 Red	Red	Tail Light	1 Pc./Card



*1953-62 Chevy Corvette*

**25 LED Front Parking Light**

- 25 super bright LEDs with high quality polycarbonate lens
- Dual function with parking light and bright turn signal
- 1953-57 Corvette may require a small notch to be filed on back edge of lens
- Easy wiring with hard wired 1157 double contact plug
- Recommend to upgrade to under dash flasher to item #90652 or 90649 LED flasher

Item Number	LEDs	Lens	Application	Pack
CPL5362A	25 Amber	Amber	Parking	1 Pc./Card
CPL5362C	25 Amber	Clear	Parking	1 Pc./Card



*1958-60 Chevy Corvette*

**Outer Tail Light Lens**

- Quality polycarbonate lens with polished stainless steel strip
- Quality red polycarbonate lens

Item Number	LEDs	Lens	Application	Pack
C5860	-	Red	Tail Light	1 Pc./Card







*1963-67 Chevy Corvette*  
**25 LED 12V Front Parking Light**

- 25 super bright LEDs with high quality polycarbonate lens
- Epoxy coated, fully sealed electronics
- Easy wiring with hard wired 1157 double contact plug
- Dual function with parking light & bright turn signal

Item Number	LEDs	Lens	Package	Pack
<b>CPL6367A</b>	25 Amber	Amber	Carded	1 Pc./Card
<b>CPL6367C</b>	25 Amber	Clear	Carded	1 Pc./Card

*1958 Chevy Passenger Car*  
*1958-67 Chevy Corvette*  
**13 LED Tail Light Lens**

- 13 super bright red LEDs with high quality polycarbonate lens
- Epoxy coated, fully sealed electronics, 1157 plug
- Solid state circuit boards are designed for 7.7 - 14.0 VDC

Item Number	LEDs	Lens	Pack
<b>CTL5860LED</b>	13 Red	Red	1 Pc./Card



*1963-66 Chevy Corvette*  
**20 LED Backup Light**

- 20 super bright white LEDs with high quality polycarbonate lens
- Epoxy coated, fully sealed electronics, 1156 plug
- Energy efficient solid-state circuit board for 12V DC systems

Item Number	LEDs	Lens	Pack
<b>CBL6366LED</b>	20 White	White	1 Pc./Card



# CHEVY EL CAMINO/WAGON

1968-69 Chevy El Camino & Station Wagon

## 30 LED Tail Light Lens

- 30 super bright LEDs with high red polycarbonate lens
- Dual function with tail light & bright stop/turn signal
- Epoxy coated, fully sealed electronics, 1157 plug
- Recommend upgrading under dash flasher to UP item # 90652 or 90649 LED flasher

Item Number	LEDs	Lens	Application	Pack
111117	30 Red	Red	Driver & Passenger	1 Pair
CTL6869LED-L	30 Red	Red	Drive	1 Pc./Card
CTL6869LED-R	30 Red	Red	Passenger	1 Pc./Card



**2** SOLD IN PAIRS

1970-72 Chevy El Camino & Station Wagon

## 36 LED Tail Light

- 36 super bright red LEDs, complete with polycarbonate lens
- Dual function with Tail Light and bright stop/turn signal
- Epoxy coated, fully sealed electronics, 1157 plug
- Recommend upgrading under dash flasher to UP item # 90652 or 90649 LED flasher

Item Number	LEDs	Lens	Application	Pack
111120	36 Red	Red	Driver & Passenger	1 Pair
CTL7072LED-L	36 Red	Red	Driver	1 Pc./Card
CTL7072LED-R	36 Red	Red	Passenger	1 Pc./Card



**2** SOLD IN PAIRS

1969 -72 Chevy El Camino

## 24 LED Backup Light

- 24 Super bright white LEDs with high quality polycarbonate lens
- Epoxy coated, fully sealed electronics, 1156 plug
- Energy efficient solid-state circuit board engineered for 12V DC systems, Lifetime warranty

Item Number	LEDs	Lens	Application	Pack
110458	24 White	Clear	Backup Light	1 Pc./Card

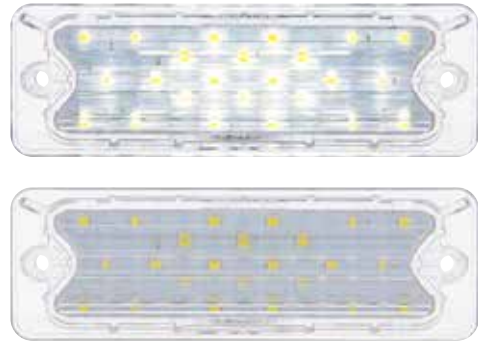

1970-72 Chevy El Camino & Station Wagon

## 36 LED Sequential Tail Light

- Super bright LED with high quality injection molded polycarbonate lens
- Dual function with tail light and bright stop/turn signal
- Features sequential operation with brake attention feature, and selector switch to turn off if desired
- Epoxy coated, fully sealed electronics
- Easy electrical connection with 1157 plug, no modification to vehicle
- LED compatible flasher required for proper operation, item #90652 or 90649

Item Number	LEDs	Lens	Application	Pack
110547	36 Red	Red	Driver	1 Pc./Card
110548	36 Red	Red	Passenger	1 Pc./Card



**LED SEQUENTIAL TURN SIGNAL**

*1960-61 Chevy Impala*

**40 LED Tail Light**

- 40 super bright red LED with high quality polycarbonate lens
- Epoxy coated, fully sealed electronics, 1157 plug
- Solid state circuit boards are designed for 7.7 - 14.0 VDC
- Chrome bezel and seals sold separately, item # C6102 & C606306
- Energy efficient solid-state circuit board for 12V DC systems
- Recommend to upgrade to under dash flasher to item #90652 or 90649 LED flasher

Item Number	LEDs	Lens	Pack
<b>CTL6061LED</b>	40 Red	Red	1 Pc./Card



*1960-61 Chevy Impala*

**40 LED Back-Up Light**

- 40 super bright white LEDs with high quality polycarbonate lens
- Epoxy coated, fully sealed electronics, 1156 plug
- Energy efficient solid-state circuit board for 12V DC systems

Item Number	LEDs	Lens	Pack
<b>CBL6051</b>	40 White	Clear	1 Pc./Card



*1962 Chevy Impala*

**40 LED Tail Light Lens**

- 40 super bright red LEDs with high quality polycarbonate lens
- Epoxy coated, fully sealed electronics, 1157 plug
- Energy efficient solid-state circuit board for 12V DC systems
- Recommend to upgrade to under dash flasher to item #90652 or 90649 LED flasher

Item Number	LEDs	Lens	Pack
<b>CTL6201LED</b>	40 Red	Red	1 Pc./Card



*1962 Chevy Impala*

**26 LED Backup Light**

- 26 Super bright white LEDs with high quality polycarbonate lens
- Epoxy coated, fully sealed electronics, 1156 plug
- Energy efficient solid-state circuit board for 12V DC systems

Item Number	LEDs	Lens	Application	Pack
<b>CBL6251LED</b>	26 White	Red/Clear	Backup Light	1 Pc./Card



**LED LIGHTS**  
**CHEVY IMPALA**

*1963 Chevy Impala*

**40 LED Tail Light**

- 40 super bright red LEDs with high quality polycarbonate lens
- Epoxy coated, fully sealed electronics, 1157 plug
- Energy efficient solid-state circuit board for 12V DC systems
- Use chrome bezel part # C6301P, lens gasket part # C6351
- Recommend to upgrade to under dash flasher to item #90652 or 90649 LED flasher

Item Number	LEDs	Lens	Pack
<b>CTL6301LED</b>	40 Red	Red	1 Pc./Card



*1963 Chevy Impala*

**26 LED Backup Light Lens**

- 26 super bright white LEDs with high quality polycarbonate lens
- Epoxy coated, fully sealed electronics, 1156 plug
- Energy efficient solid-state circuit board for 12V DC systems
- Use chrome bezel part # C6301P, lens gasket part # C6351

Item Number	LEDs	Lens	Pack
<b>CBL6351LED</b>	26 Red	Red/Clear	1 Pc./Card



*1964 Chevy Impala*

**41 LED Tail Light Lens**

- 41 super bright LEDs with high quality polycarbonate lens
- Epoxy coated, fully sealed electronics, 1157 plug
- Energy efficient solid-state circuit board for 12V DC systems
- Recommend to upgrade to under dash flasher to item #90652 or 90649 LED flasher

Item Number	LEDs	Lens	Pack
<b>CTL6401LED</b>	41 Red	Red	1 Pc./Card



*1964 Chevy Impala*

**26 LED Backup Light**

- 26 Super bright white LEDs with high quality polycarbonate lens
- Epoxy coated, fully sealed electronics, 1156 plug
- Energy efficient solid-state circuit board for 12V DC systems

Item Number	LEDs	Lens	Application	Pack
<b>CBL6451LED</b>	26 White	Red/Clear	Backup Light	1 Pc./Card



*1965 Chevy Impala*

**41 LED Tail Light With Stainless Trim**

- 41 super bright LEDs with high quality polycarbonate lens
- Polished stainless steel trim
- Epoxy coated, fully sealed electronics, 1157 plug
- Energy efficient solid-state circuit board for 12V DC systems
- Recommend to upgrade to under dash flasher to item #90652 or 90649 LED flasher

Item Number	LEDs	Lens	Pack
<b>CTL6501LED</b>	41 Red	Red	1 Pc./Card
<b>CTL6501C</b>	41 Red	Clear	1 Pc./Card



*1965 Chevy Impala*

**26 LED Back-Up Light With Stainless Trim**

- 26 super bright white LEDs, w/ polycarbonate lens and stainless trim
- Epoxy coated, fully sealed electronics, 1156 plug
- Solid state circuit boards are designed for 7.7 - 14.0 VDC

Item Number	LEDs	Lens	Pack
<b>CBL6551LED</b>	26 Red	Red/Clear	1 Pc./Card



*1966 Chevy Impala*

**30 LED Parking Light Lens**

- 30 super bright amber LEDs with high quality polycarbonate lens
- New lens is the same size & shape as original Impala lens
- Dual function with parking light & bright turn signal
- Easy electrical connection with 1157 plug, no modification to vehicle
- Recommend to upgrade under dash flasher to item # 90652 or 90649 LED flasher
- Gasket sold separately, item # C6651

Item Number	LEDs	Lens	Pack
<b>CPL6601LED</b>	30 Amber	Amber	1 Pc./Box



*1967 Chevy Impala*

**27 LED Parking Light Lens**

- 27 super bright amber LEDs with high quality polycarbonate lens
- New lens is the same size & shape as original Impala lens
- Dual function with parking light & bright turn signal
- Easy electrical connection with 1157 plug, no modification to vehicle
- Recommend to upgrade under dash flasher to item # 90652 or 90649 LED flasher
- Gasket sold separately, item # C6751

Item Number	LEDs	Lens	Pack
<b>CPL6701LED</b>	27 Amber	Amber	1 Pc./Box



**LED LIGHTS**  
**CHEVY IMPALA**

1968 Chevy Caprice/Impala

**40 LED Tail Light With Stainless Steel Trim**

- 40 super bright red LEDs with high quality polycarbonate lens
- Beautiful polished outer and inner stainless steel trims
- Epoxy coated, fully sealed electronics, 1157 plug
- Energy efficient solid-state circuit board for 12V DC systems
- Recommend to upgrade to under dash flasher to item #90652 or 90649 LED flasher

Item Number	LEDs	Lens	Function	Pack
<b>CTL6801LED</b>	40 Red	Red	Tail	1 Pc./Card
<b>CTL6801C</b>	40 Red	Clear	Tail	1 Pc./Card



1968 Chevy Bel-Air/Biscayne

**40 LED Tail light With Stainless Steel Center Trim**

- 40 super bright red LEDs with high quality polycarbonate lens
- Beautiful polished inner stainless steel trim
- Epoxy coated, fully sealed electronics, 1157 plug
- Energy efficient solid-state circuit board for 12V DC systems

Item Number	LEDs	Lens	Function	Pack
<b>CTL6802LED</b>	40 Red	Red	Tail	1 Pc./Card



1968 Chevy Caprice/Impala

**26 LED Backup Light With Stainless Steel Trim**

- 26 super bright red LEDs with high quality polycarbonate lens
- Beautiful polished outer and inner stainless steel trims
- Epoxy coated, fully sealed electronics, 1157 plug
- Energy efficient solid-state circuit board for 12V DC systems

Item Number	LEDs	Lens	Function	Pack
<b>CBL6851LED</b>	26 White	Clear	Back-Up	1 Pc./Card



1968 Chevy Bel Air/Biscayne

**26 LED Backup Light W/ Stainless Steel Trim**

- 26 super bright white LEDs with high quality polycarbonate lens
- Beautiful polished outer and inner stainless steel trims
- Epoxy coated, fully sealed electronics, 1157 plug
- Energy efficient solid-state circuit board for 12V DC systems

Item Number	LEDs	Lens	Function	Pack
<b>CBL6852LED</b>	26 White	Clear	Back-Up	1 Pc./Card



1966-67 Chevy II & Nova

**68 LED One-Piece Style Tail Light**

- 68 SMD LED tail light w/ high quality red polycarbonate lens
- Custom style on-piece design with backup light deleted
- Epoxy coated, fully sealed electronics, 1157 plug
- Energy efficient solid-state circuit board for 12V DC systems
- Recommend license plate with LED backup light, item # 50187
- Recommend to upgrade under dash flasher to item # 90652 or 90649 LED flasher

Item Number	LEDs	Lens	Pack
<b>110359</b>	68 Red	Red	1 Pc./Card



1966-67 Chevy II & Nova

**68 LED Sequential One-Piece Style Tail Light**

- 68 SMD super bright LED sequential tail light with high quality polycarbonate lens
- Custom style on-piece design with backup light deleted
- Features sequential function with selector switch to control sequential function off, direction left, or direction right
- Also features brake attention option with sequence-once function
- Epoxy coated, fully sealed electronics, 1157 plug
- Solid state circuit boards are designed for 7.7 - 14.0 VDC
- Recommend license plate with LED backup light, item # 50187
- Recommend to upgrade under dash flasher to item # 90652 or 90649 LED flasher

Item Number	LEDs	Lens	Pack
<b>110360</b>	68 Red	Red	1 Pc./Card

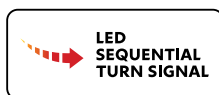

1966-67 Chevy Nova

**30 LED Tail Light**

- 30 super bright LEDs with high quality polycarbonate lens
- Epoxy coated, fully sealed electronics, 1157 plug
- Energy efficient solid-state circuit board for 12V DC systems
- Recommend to upgrade under dash flasher to item # 90652 or 90649 LED flasher

Item Number	LEDs	Lens	Pack
<b>CTL6667LED</b>	30 Red	Red	1 Pc./Card



1966-67 Chevy Nova

**24 LED Backup Light**

- 24 super bright LEDs with high quality polycarbonate lens
- Epoxy coated, fully sealed electronics, 1156 plug
- Energy efficient solid-state circuit board for 12V DC systems

Item Number	LEDs	Lens	Pack
<b>CBL6667LED</b>	24 White	Clear	1 Pc./Card



1966-67 Chevy Nova

**Tail Light Lens Gasket (Pair)**

- Quality thick black foam gasket
- Die cut to the exact shape and size as original to provide a nice tight seal

Item Number	Description	Application	Pack
<b>C666702</b>	Black foam tail light gaskets	LH & RH	1 Pair

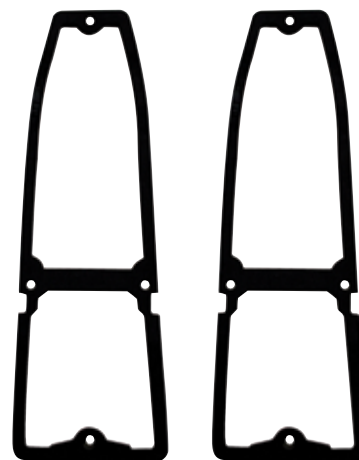

1962-64 Chevy Nova

**26 LED Tail Light Lens**

- 26 super bright LEDs with high quality polycarbonate lens
- Epoxy coated, fully sealed electronics, 1157 plug
- Solid state circuit boards are designed for 7.7 - 14.0 VDC
- Energy efficient solid-state circuit board for 12V DC systems
- Recommend to upgrade under dash flasher to item # 90652 or 90649 LED flasher

Item Number	LEDs	Lens	Pack
<b>CTL6264LED</b>	26 Red	Red	1 Pc./Card



1962-64 Chevy Nova

**26 LED Sequential Tail Light**

- Super bright red LED with high quality injection molded polycarbonate lens
- Epoxy coated, fully sealed electronics
- Easy electrical connection with 1157 plug, no modification to vehicle
- LED compatible flasher required for proper operation, item #90652 or 90649
- Features sequential operation with selector switch to select sequential left, sequential right, or sequential function off
- Also features brake attention option with sequence-once function

Item Number	LEDs	Lens	Pack
<b>110268</b>	26 Red	Red	1 Pc./Card

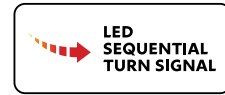

1962-64 Chevy Nova

**32 LED Backup Light**

- 32 super bright white LEDs with high quality polycarbonate lens
- Epoxy coated, fully sealed electronics, 1156 plug
- Energy efficient solid-state circuit board for 12V DC systems

Item Number	LEDs	Lens	Pack
<b>CBL6264LED</b>	32 White	Clear	1 Pc./Card



1968-69 Chevy Nova

**36 LED Tail Light**

- 36 super bright LEDs with high quality polycarbonate lens
- Dual function with tail light & bright stop/turn signal
- All red lens without backup light, fits L/H or R/H side
- Epoxy coated, fully sealed electronics, 1157 plug
- Recommend to upgrade under dash flasher to item # 90652 or 90649 LED flasher

Item Number	LEDs	Lens	Application	Pack
<b>CTL6826LED</b>	36 Red	Red	LH & RH	1 Pc./Card

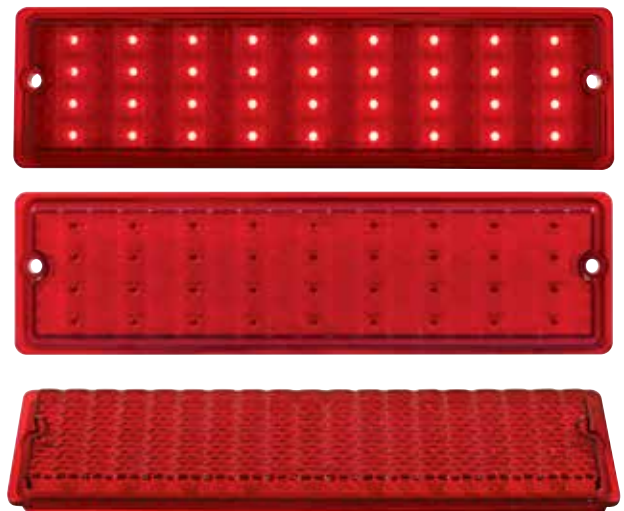



**LED LIGHTS**  
**1940's-50's CHEVY TRUCK**



1940-53 Chevy & GMC Truck

**27 LED Sequential Tail Light**

- 27 super bright red LEDs with high quality polycarbonate lens
- Highly polished stainless steel housing
- Includes LED license illuminator lens with 6 bright white LEDs
- Features sequential function with selector switch to control sequential function off/on
- Also features brake attention option with sequence-once function
- Recommend to upgrade under dash flasher to item # 90652 or 90649 LED flasher



Item Number	LEDs	Lens	Application	Pack
110419	Red	Red	Driver	1 Pc./Box
110420	Red	Red	Passenger	1 Pc./Box

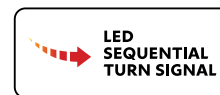

**LED LIGHTS**  
**1940s-50s CHEVY TRUCK**

1940-53 Chevy & GMC Truck

**45 LED Tail Light Assembly**

- 45 super bright red SMD LEDs with high quality polycarbonate lens
- Additional white LED with clear lens for license plate light
- Fully assembled gloss black or stainless steel die stamped metal housing with mounting studs
- Energy efficient solid-state circuit board for 12V DC systems
- Recommend to upgrade under dash flasher to item # 90652 or 90649 LED flasher

Item Number	Housing	Lens	Application	Pack
C7031RL	Black	Red	Driver	1 Pc./Card
C7031RR	Black	Red	Passenger	1 Pc./Card
C7033RL	Stainless	Red	Driver	1 Pc./Card
C7033RR	Stainless	Red	Passenger	1 Pc./Card



1940-53 Chevy Truck

**23 LED Tail Light Assembly with LED Blue Dot**

- 23 super bright red LEDs with LED blue dot, 6 white LEDs for license
- Available with black or stainless steel housing
- Blue dot can be controlled independently with additional wiring. For example, the blue dot can be turned-off, or be turned-on independently from Tail Light

Item Number	Housing	Lens	Application	Pack
C7031RLBD	Black	Red	Driver	1 Pc./Box
C7031RRBD	Black	Red	Passenger	1 Pc./Box
C7033RLBD	Stainless	Red	Driver	1 Pc./Box
C7033RRBD	Stainless	Red	Passenger	1 Pc./Box



1940-53 Chevy & GMC Truck

**Tail Light Lens Gasket**

- Fits between the tail light housing and lens
- Made of quality cork-neoprene material as original
- Die cut to the exact shape and size as original to provide a nice tight seal

Item Number	Description	Package	Pack
C4009G	Tail Light Lens Gasket	Card	1 Pc./Card





**2** SOLD IN PAIRS

1940-53 Chevy & GMC Truck  
 1937-38 Chevy Car

**23 LED Tail Light Set w/ LED Blue Dot**

- 23 super bright red LEDs with LED blue dot, 6 white LEDs for license
- Dual function with tail light and bright stop/turn signal
- Blue dot can be controlled independently with additional wiring
- High quality injection molded polycarbonate lens
- Epoxy coated, fully sealed electronics
- Energy efficient solid-state circuit board for 12V DC systems
- Set includes both L/H & R/H tail light lens, housing not included

Item Number	LEDs	Lens	Application	Pack
110750	Red	Red	L/H & R/H	1 Pair

1947-53 Chevy Truck

**24 LED Parking and Turn Signal Light**

- 24 super bright amber LEDs, complete with polycarbonate lens
- Dual function with parking light and bright turn signal
- Epoxy coated, fully sealed electronics, 1157 plug
- Gasket sold separately, item # C475308

Item Number	LEDs	Lens	Application	Pack
CPL4753A	24 Amber	Amber	Park/Turn	1 Pc./Card
CPL4753C	24 Amber	Clear	Park/Turn	1 Pc./Card



1947-53 Chevy Truck

**24 LED Parking and Turn Signal Light Assembly**

- Complete LED parking and turn signal light
- Polished stainless steel or chrome bezel with black housing
- 24 super bright amber LEDs, complete with polycarbonate lens
- Dual function with parking light and bright turn signal
- Epoxy coated, fully sealed electronics, 1157 plug

Item Number	Housing	LEDs	Lens	Pack
CPL4753A-AC	Chrome	24 Amber	Amber	1 Pc./Box
CPL4753C-AC	Chrome	24 Amber	Clear	1 Pc./Box
CPL4753A-AS	Stainless	24 Amber	Amber	1 Pc./Box
CPL4753C-AS	Stainless	24 Amber	Clear	1 Pc./Box



**LED LIGHTS**

# 1950's-60's CHEVY TRUCK



## 1960-66 Chevy Fleetside Truck

### 33 LED Parking Light

- 33 super bright LED parking light with polycarbonate lens
- Dual function with parking light & bright turn signal
- Fits L/H or R/H side
- Epoxy coated, fully sealed electronics, 1157 plug

Item Number	LEDs	Lens	Application	Pack
CPL6066A	33 Amber	Amber	Park/Turn	1 Pc./Card

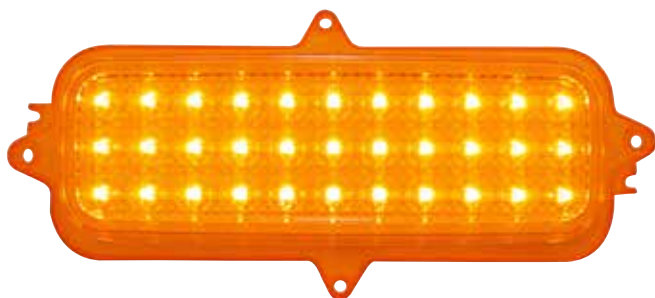

**1955-57 Chevy Truck**

**39 LED Parking Light**

- 39 super bright LED parking light with polycarbonate lens
- Dual function with parking light & bright turn signal
- Easy electrical connection with 1157 plug, no modification to vehicle
- Lifetime warranty

Item Number	LEDs	Lens	Package	Pack
<b>CPL5557A</b>	39 Amber	Amber	Carded	1 Pc./Card
<b>CPL5557C</b>	39 Amber	Clear	Carded	1 Pc./Card



**1951-53 GMC Truck**

**38 LED Parking Light**

- 38 Amber LED parking light with clear lens
- Fits L/H or R/H side

Item Number	LEDs	Lens	Application	Pack
<b>CPL5153C</b>	38 Amber	Clear	LH & RH	1 Pc./Card



**1951-53 GMC Truck**

**LED Parking Light Lens**

- High quality polycarbonate replacement lens
- Excellent reproduction of the original design

Item Number	LEDs	Lens	Application	Pack
<b>C515301</b>	-	Clear	Parking	1 Pc./Bag



**1958-59 Chevy & GMC Truck**

**41 LED Tail Light Lens**

- 41 super bright red LEDs with high quality polycarbonate lens
- Epoxy coated, fully sealed electronics, 1157 plug
- Energy efficient solid-state circuit board for 12V DC systems
- Recommend to upgrade under dash flasher to item # 90652 or 90649 LED flasher

Item Number	LEDs	Lens	Application	Pack
<b>CTL5859LED</b>	41 Red	Red	Tail Light	1 Pc./Card
<b>CTL5859C</b>	41 Red	Clear	Tail Light	1 Pc./Card



# 1950s-60s CHEVY TRUCK

## 1954-59 Chevy & GMC 2nd Series Stepside Truck

### 29 LED Sequential Tail Light

- 29 super bright red LEDs tail light with polycarbonate lens
- Features sequential operation with selector switch to select sequential left, sequential right, or sequential function off
- Also features brake attention option with sequence-once function
- Easy electrical connection with 1157 plug, no modification to vehicle
- Recommend to upgrade under dash flasher to item # 90652 or 90649 LED flasher

Item Number	LEDs	Lens	Application	Pack
110405	29 Red	Red	Tail light	1 Pc./Card

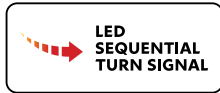
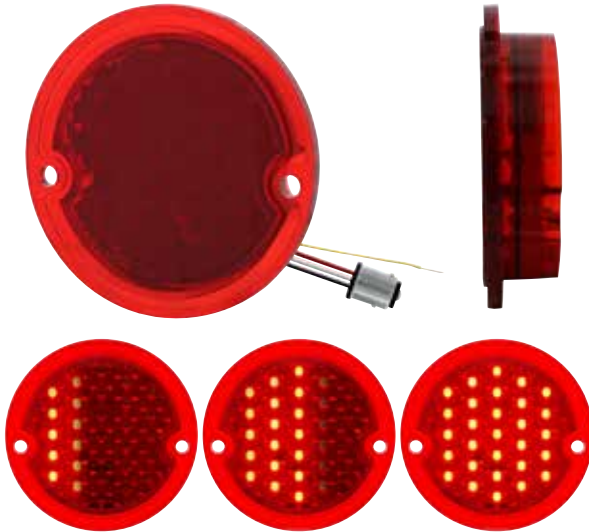

## 1954-59 Chevy & GMC Truck

### 29 LED Sequential Tail Light W/ Stainless Steel Housing

- 29 super bright red LED sequential tail light, with polished stainless steel housing and bezel
- Selector switch to control sequential function off, direction left, or direction right
- Also features brake attention option with sequence-once function
- Easy electrical connection w/ 1157 plug, no modification to vehicle
- Energy efficient solid-state circuit board for 12V DC systems
- Recommend to upgrade under dash flasher to item # 90652 or 90649 LED flasher

Item Number	LEDs	Lens	Application	Pack
110768	29 Red	Red	Tail Light	1 Pc./Card

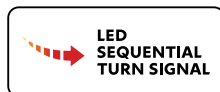

## 1954-59 Chevy & GMC Truck

### 29 LED Tail Light

- 29 super bright red LEDs tail light with polycarbonate lens
- Easy electrical connection with 1157 plug, no modification to vehicle
- Recommend to upgrade under dash flasher to item # 90652 or 90649 LED flasher

Item Number	LEDs	Lens	Application	Pack
110404	29 Red	Red	Tail light	1 Pc./Card

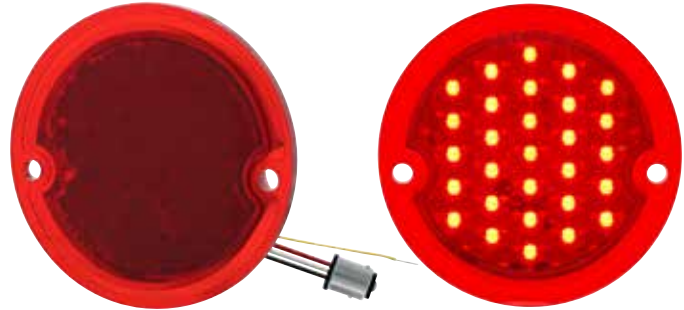

## 1955-59 Chevy Truck

### Tail Light Lens Gasket

- Black foam rubber as original

Item Number	Description	Package	Pack
C555911-3	Tail Light Lens Gasket	Card	1 Pc./Card

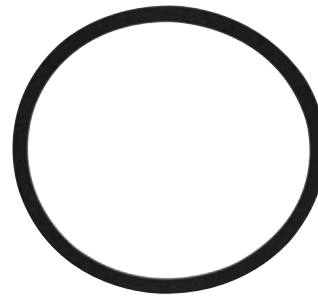

## 1954-59 Chevy & GMC Truck

### 29 LED Tail Light W/ Stainless Steel Housing

- 29 super bright red LED tail light with highly polished stainless steel housing
- Epoxy coated, fully sealed electronics, 1157 plug
- Energy efficient solid-state circuit board for 12V DC systems
- Recommend to upgrade under dash flasher to item # 90652 or 90649 LED flasher

Item Number	LEDs	Lens	Application	Pack
110766	29 Red	Red	Tail Light	1 Pc./Card



**LED LIGHTS**  
**1950s-60s CHEVY TRUCK**

1954-59 Chevy & GMC Truck

**29 LED Sequential Tail Light W/ Black Housing**

- 29 super bright red LED sequential tail light with gloss black powder coated housing and polished stainless steel bezel
- Selector switch to control sequential function off, direction left, or direction right
- Also features brake attention option with sequence-once function
- Epoxy coated, fully sealed electronics, 1157 plug
- Upgrade under dash flasher to item # 90652 or 90649 LED flasher

Item Number	LEDs	Lens	Application	Pack
<b>110767</b>	29 Red	Red	Tail Light	1 Pc./Card



1960-66 Chevy Stepside Truck

**41 LED Tail Light**

- 41 super bright red LEDs with high quality polycarbonate lens
- Epoxy coated, fully sealed electronics, 1157 plug
- Energy efficient solid-state circuit board for 12V DC systems
- Recommend to upgrade under dash flasher to item # 90652 or 90649 LED flasher

Item Number	LEDs	Lens	Application	Pack
<b>CTL6066LED</b>	41 Red	Red	Tail Light	1 Pc./Card
<b>CTL6066C</b>	41 Red	Clear	Tail Light	1 Pc./Card



1954-59 Chevy & GMC Truck

**29 LED Tail Light W/ Black Housing**

- 29 super bright red LED tail light, with gloss black powder coated housing and polished stainless steel bezel
- Epoxy coated, fully sealed electronics, 1157 plug
- Recommend to upgrade under dash flasher to item # 90652 or 90649 LED flasher

Item Number	LEDs	Lens	Application	Pack
<b>110765</b>	29 Red	Red	Tail Light	1 Pc./Card



1960-66 Chevy Stepside Truck

**41 LED Tail Light Assembly**

- 41 super bright red LEDs with high quality polycarbonate lens
- Black or stainless steel housing, lens, gasket, socket & wiring
- Epoxy coated, fully sealed electronics, 1157 plug
- Energy efficient solid-state circuit board for 12V DC systems

Item Number	Housing	Lens	Application	Pack
<b>CTL6066BR</b>	Black	Red	Tail Light	1 Pc./Box
<b>CTL6066BC</b>	Black	Clear	Tail Light	1 Pc./Box
<b>CTL6066SR</b>	Stainless	Red	Tail Light	1 Pc./Box
<b>CTL6066SC</b>	Stainless	Clear	Tail Light	1 Pc./Box



LED LIGHTS

# 1960-66 CHEVY TRUCK



1960-66 Chevy & GMC Fleetside Truck

### 40 LED Sequential Tail Light Assembly

- 40 super bright red LEDs with high quality polycarbonate lens
- Features sequential function with selector switch to control sequential function off, direction left, or direction right
- Features sequence-once brake attention function
- OE style wiring with bullet terminal connectors
- Epoxy coated, fully sealed electronics
- Recommend to upgrade under dash flasher to item # 90652 or 90649 LED flasher

Item Number	LEDs	Lens	Application	Pack
110795	40 Red	Red	Tail Light	1 Pc./Card





1960-66 Chevy & GMC Fleetside Truck

**40 LED Tail Light Assembly**

- 40 super bright red LEDs with high quality polycarbonate lens
- Complete with housing, lens, gasket, socket & wiring
- Fully assembled, ready to install right out of the box
- Recommend to upgrade under dash flasher to item # 90652 or 90649 LED flasher

Item Number	LEDs	Lens	Application	Pack
<b>CTL6066FSR</b>	40 Red	Red	Tail Light	1 Pc./Card
<b>CTL6066FSC</b>	40 Red	Clear	Tail Light	1 Pc./Card



1960-66 Chevy & GMC Fleetside Truck

**40 LED Sequential Tail Light Assembly**

- 40 super bright red LEDs with high quality polycarbonate lens
- Features sequential function with selector switch to control sequential function off, direction left, or direction right
- Also features sequence-once brake attention function
- Epoxy coated, fully sealed electronic, 1157 plug
- Recommend to upgrade under dash flasher to item # 90652 or 90649 LED flasher

Item Number	LEDs	Lens	Application	Pack
<b>110199</b>	40 Red	Red	Tail Light	1 Pc./Card



1960-66 Chevy & GMC Fleetside Truck

**40 LED Tail Light Lens**

- 40 super bright red LEDs with high quality polycarbonate lens
- Epoxy coated, fully sealed electronics, 1157 plug
- Energy efficient solid-state circuit board for 12V DC systems
- Recommend to upgrade under dash flasher to item # 90652 or 90649 LED flasher

Item Number	LEDs	Lens	Application	Pack
<b>CTL6066FSLED</b>	40 Red	Red	Tail Light	1 Pc./Card
<b>CTL6066FC</b>	40 Red	Clear	Tail Light	1 Pc./Card



1960-66 Chevy & GMC Fleetside Truck

**Tail Light Lens Gasket (Pair)**

- White foam rubber as original
- Die cut to the exact shape and size as original to provide nice a tight seal

Item Number	Description	Package	Pack
<b>C606651</b>	Tail Light Gasket	Carded	1 Pair

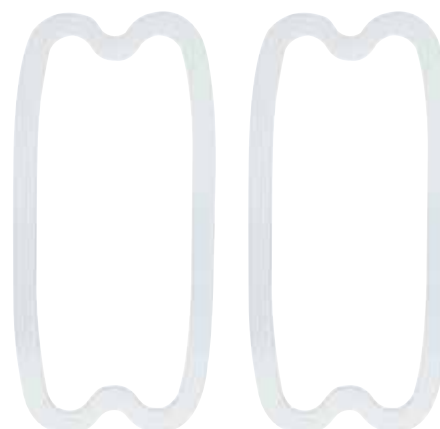

**LED LIGHTS**  
**C10 CHEVY TRUCK**





**LED LIGHTS**  
**C10 CHEVY TRUCK**

1967-72 Chevy & GMC Fleetside Truck

**20 LED TAIL LIGHT - CLEAR LENS**

- Super bright red LED with high quality injection molded polycarbonate lens
- Epoxy coated, fully sealed electronics
- Easy electrical connection w/ 1157 plug, no modification to vehicle
- Energy efficient solid-state circuit board engineered for 12V DC systems
- LED compatible flasher required for proper operation, item #90652 or 90649

Item Number	LEDs	Lens	Application	Pack
<b>CTL6721C</b>	20 Red	Clear	Tail Light	1 Pc./Card



1967-72 Chevy & GMC Fleetside Truck

**20 LED Sequential & Non Sequential Tail Lights**

- 20 super bright red LEDs with high quality polycarbonate lens
- Features sequential operation with selector switch to select sequential left, sequential right, or sequential function off
- Epoxy coated, fully sealed electronics, 1157 plug
- Energy efficient solid-state circuit board for 12V DC systems
- Upgrade under dash flasher to item # 90652 or 90649 LED flasher

Item Number	LEDs	Lens	Application	Pack
<b>CTL6721SEQ</b>	20 Red	Red	Tail Light	1 Pc./Card
<b>CTL6721LED</b>	20 Red	Red	Tail Light	1 Pc./Card

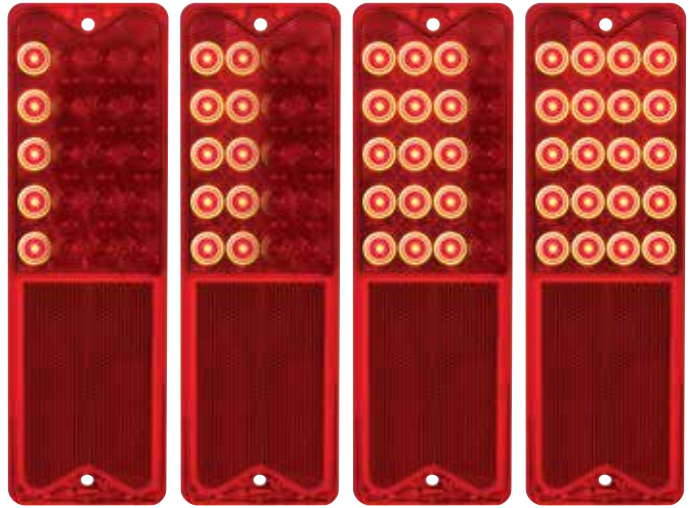

1967-72 Chevy & GMC Fleetside Truck

**20 LED Sequential & Non Sequential Tail Light Assembly**

- 20 super bright red LEDs with high quality polycarbonate lens
- Features sequential operation with selector switch to select sequential left, sequential right, or sequential function off
- Epoxy coated, fully sealed electronics, 1157 plug
- Energy efficient solid-state circuit board for 12V DC systems
- Die stamped steel housing with mounting studs, socket, and gasket
- Recommend to upgrade under dash flasher to item # 90652 or 90649 LED flasher

Item Number	LEDs	Lens	Application	Pack
<b>110214</b>	20 RED	RED	Sequential	1 Pc./Card
<b>110213</b>	20 RED	RED	Non-Seq.	1 Pc./Card

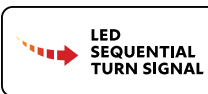
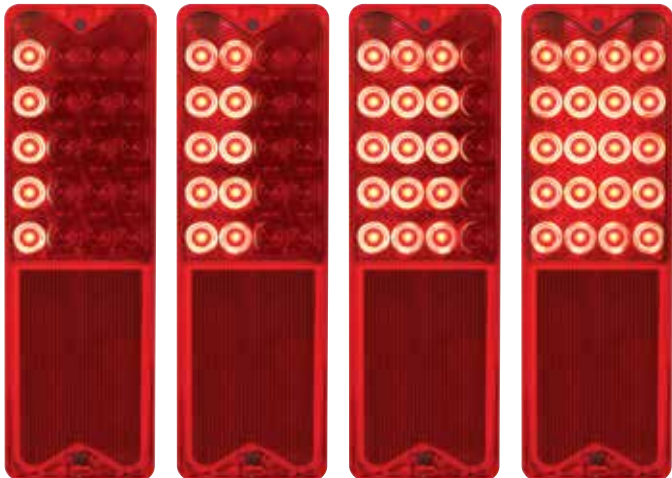

1967-72 Chevy & GMC Suburban & Fleetside

**61 Red LED Tail Light Insert**

- 61 Super bright red LED circuit board installs behind existing lens
- Dual function with tail light & bright stop/turn signal
- Easy wiring with hard wired 1157 double contact plug, no modification to vehicle
- Mold to fit original housing, foam padding and tabs to secure
- Recommend to upgrade under dash flasher to item # 90652 or 90649 LED flasher

Item Number	LEDs	Lens	Application	Pack
110126	61	-	Tail Light	1 Pc./Card

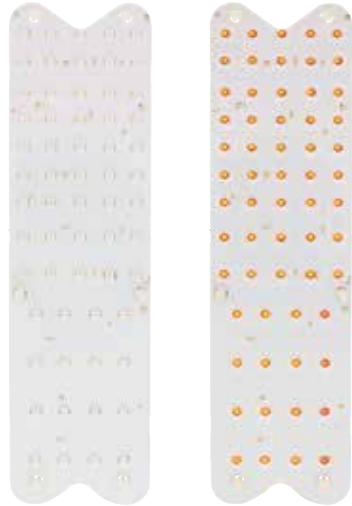

1967-72 Chevy & GMC Truck

**Tail Light Lens Gaskets (Pair)**

- Fits between tail light housing and lens
- White foam rubber as original
- Die cut to the exact shape and size as original to provide a nice tight seal

Item Number	Description	Package	Pack
110215	Tail Light Lens Gasket	Carded	1 Pair



**2** SOLD IN PAIRS

1967-72 Chevy & GMC Truck

**30 LED Backup Light**

- 30 super bright white LED bullseye lens
- Epoxy coated, fully sealed electronics, 1156 plug
- Energy efficient solid-state circuit board for 12V DC systems

Item Number	LEDs	Lens	Application	Pack
111110	30 White	Clear	Backup	1 Pair
110200	30 White	Clear	Driver	1 Pc./Card
110201	30 White	Clear	Passenger	1 Pc./Card



**2** SOLD IN PAIRS

1967-72 Chevy & GMC Truck

**Backup Light Gasket (Pair)**

- Fits between tail light housing and lens
- White foam rubber as original, die cut to the exact shape and size as original to provide a nice tight seal

Item Number	Description	Package	Pack
110202	Backup Light Gasket	Card	1 Pair

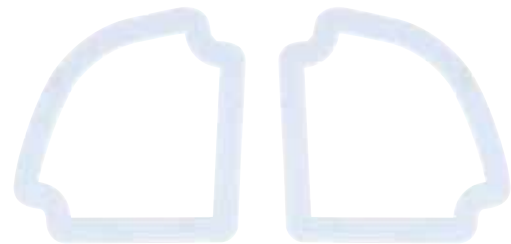

**2** SOLD IN PAIRS

**LED LIGHTS**  
**C10 CHEVY TRUCK**

1967-72 Chevy & GMC Fleetside Truck

**Tail Light Lens**

- Great looking replacement lens (no GM markings)
- High quality injection molded polycarbonate lens
- Fits L/H or R/H

Item Number	LEDs	Lens	Application	Pack
<b>C677209</b>	-	Red	Tail Light	1 Pc./Card



1967-72 Chevy Stepside Truck

**LED Tail Light**

- 25 super bright red LEDs with high quality polycarbonate lens
- Epoxy coated, fully sealed electronics, 1157 plug
- Energy efficient solid-state circuit board for 12V DC systems
- Recommend to upgrade under dash flasher to item # 90652 or 90649 LED flasher

Item Number	LEDs	Lens	Application	Pack
<b>CTL6772LED</b>	25 Red	Red	Tail Light	1 Pc./Card



1973-87 Chevy & GMC Truck

**56 LED Sequential Tail Light**

- 56 super bright red LED tail light with 12 LED white back-up light
- Features sequential operation with brake attention feature, and selector switch to turn off if desired
- Special tail light mounting base plate included
- Electronics completely sealed in epoxy to resist corrosion and moisture
- LED compatible flasher required for proper operation, item #90652 or 90649
- Set includes L/H #CTL7387LED-L & R/H #CTL7387LED-R pair pre-packed in one box for shipping

Item Number	LEDs	Lens	Application	Pack
<b>111113</b>	56 Red	Red	Driver	1 Pair
<b>CTL7387LED-L</b>	56 Red	Red	Driver	1 Pc./Card
<b>CTL7387LED-R</b>	56 Red	Red	Passenger	1 Pc./Card

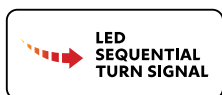

1973-87 Chevy & GMC Truck

**Tail Light Lens Gasket (Pair)**

- Black EVA foam
- Precision die cut to OE specifications for a perfect fit

Item Number	Description	Package	Pack
<b>C738703</b>	Tail Light Lens Gasket	Card	1 Pair

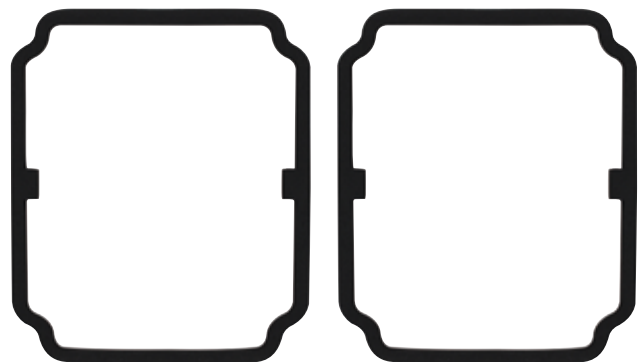

1973-87 Chevy & GMC Truck

**56 LED Sequential Tail Light With Trim**

- 56 super bright red LED tail light with 12 LED white back-up light
- Features sequential operation with brake attention feature, selector switch to turn off if desired
- Special tail light mounting base plate included
- Electronics completely sealed in epoxy to resist corrosion and moisture
- Requires use of United Pacific LED turn signal flasher, item # 90652 or 90649

Item Number	LEDs	Lens	Application	Pack
111112	56 Red	Red	Driver & Passenger	1 Pair
110843	56 Red	Red	Driver	1 Pc./Card
110844	56 Red	Red	Passenger	1 Pc./Card

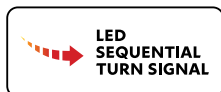

1988-98 Chevy & GMC Truck

**16 LED Tail Light (Pair)**

- Feature 16 bright red LEDs for driving, stop, and turn signal light
- Quality engineered plastic lens with durable polycarbonate housing
- Easy plug-in design with OE style connector
- Original style rear housing mounting tabs
- Compatible with standard 12V DC system
- Uses standard 3157 type bulb for back-up light (bulb not included)
- Also fits 1992-99 Chevy/GMC Suburban, 1995-99 Chevy Tahoe, 1992-94 Chevy Blazer & GMC Jimmy, and 1992-99 GMC Yukon
- Due to design of the rear mounted resistors, modification to tail light housing may require for proper fitment

Item Number	LEDs	Lens	Application	Pack
110545	16 Red	Red/Clear	Driver & Passenger	1 Pair
110546	16 Red	Smoked	Driver & Passenger	1 Pair



**LED LIGHTS**  
**C10 CHEVY TRUCK**

*1967-68 Chevy Truck*

**27 LED Parking Light Lens**

- 27 super bright amber LEDs with high quality polycarbonate lens
- Dual function with parking light & bright turn signal
- Epoxy coated, fully sealed electronics, 1157 plug

Item Number	LEDs	Lens	Application	Pack
<b>CPL6768A</b>	27 Amber	Amber	Park/Turn	1 Pc./Card
<b>CPL6768C</b>	27 Amber	Clear	Park/Turn	1 Pc./Card



*1969-70 Chevy Truck*

**36 LED Parking Light Lens**

- 36 super bright amber LEDs, complete with polycarbonate lens
- Dual function with parking light & bright turn signal
- Epoxy coated, fully sealed electronics, 1157 plug
- Solid state circuit boards are designed for 7.7 - 14.0 VDC
- Recommend to upgrade to under dash flasher to item #90652 or 90649 LED flasher

Item Number	LEDs	Lens	Application	Pack
<b>CPL6970AL</b>	36 Amber	Amber	Driver	1 Pc./Card
<b>CPL6970AR</b>	36 Amber	Amber	Passenger	1 Pc./Card
<b>CPL6970CL</b>	36 Amber	Clear	Park/Turn	1 Pc./Card
<b>CPL6970CR</b>	36 Amber	Clear	Passenger	1 Pc./Card

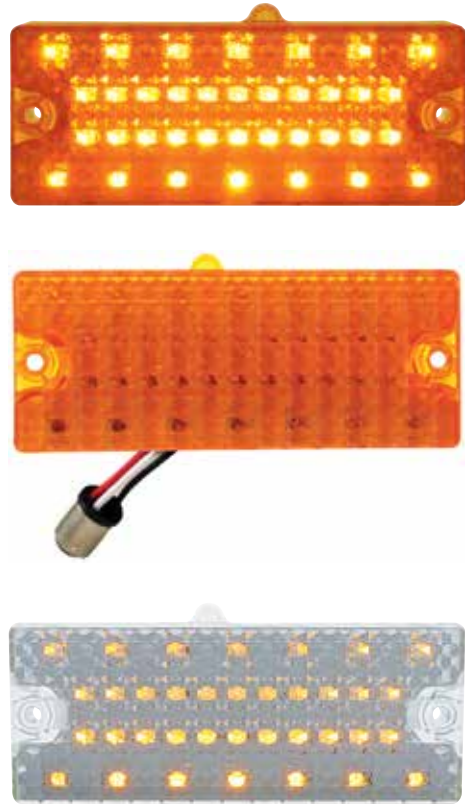

*1971-72 Chevy Truck*

**34 LED Parking Light Lens**

- 34 super bright LEDs with high quality injection molded polycarbonate lens, fits L/H or R/H
- Epoxy coated, fully sealed electronics, 1157 plug
- Recommend to upgrade to under dash flasher to item #90652 or 90649 LED flasher

Item Number	LEDs	Lens	Application	Pack
<b>CPL7172A</b>	34 Amber	Amber	LH & RH	1 Pc./Card
<b>CPL7172C</b>	34 Amber	Clear	LH & RH	1 Pc./Card

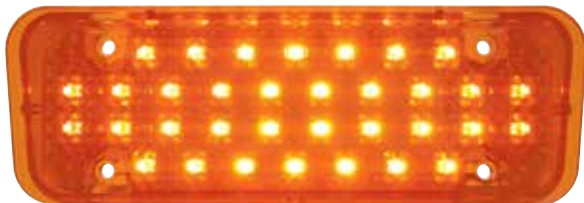



1973-80 Chevy & GMC Truck

**17 AMBER LED FRONT PARKING LIGHT WITH SS TRIM**

- High quality injection molded polycarbonate lens
- Fully epoxy sealed electronics to resist corrosion and moisture
- Feature 17 bright SMD type amber LEDs
- Beautiful stainless steel trim
- Dual function with parking light & bright turn signal
- Easy electrical connection with 1157 plug, no modification to vehicle
- Some applications may require the indexing tab to be removed
- LED compatible flasher required for proper operation, item #90652 or 90649
- DOT/SAE, FMVSS 108
- 111108 set includes L/H #110885 & R/H #110886 pair pre-packed in one box for shipping

Item Number	LEDs	Lens	Application	Pack
111108	17 Amber	Amber	Parking/Turn	1 Set./Box
111109	17 Amber	Clear	Parking/Turn	1 Set./Box
110885	17 Amber	Amber	Left Hand	1 Pc./Card
110886	17 Amber	Amber	Right Hand	1 Pc./Card
110964	17 Amber	Clear	Left Hand	1 Pc./Card
110965	17 Amber	Clear	Right Hand	1 Pc./Card



**2** SOLD IN PAIRS

1969-72 Chevy & GMC Truck

**18 LED 3rd Brake & Cargo Light**

- 18 super bright white LED cargo light with integrated 9 red LED 3rd brake light feature
- Plug & play with 1004 double contact plug as original
- 1004 double contact plug, straight pins
- Third brake light requires additional wiring, instructions included
- Epoxy coated, fully sealed electronics
- Energy efficient solid-state circuit board for 12V DC systems

Item Number	LEDs	Lens	Application	Pack
110127	18 White 9Red	Clear	Brake/Cargo	1 Pc./Card



1988-93 Chevy & GMC Truck

**21 LED CARGO LIGHT & BRAKE LIGHT**

- 14 white LED cargo light with integrated 7 red LED 3rd brake light feature
- Easy plug-in design with OE style plug
- Third brake light requires additional wiring. Wiring instructions included
- Epoxy coated, fully sealed electronics
- Energy efficient solid-state circuit board engineered for 12V DC systems
- Lifetime warranty

Item Number	LEDs	Lens	Application	Pack
110549	14 White 7	Clear	Brake/Cargo	1 Pc./Card

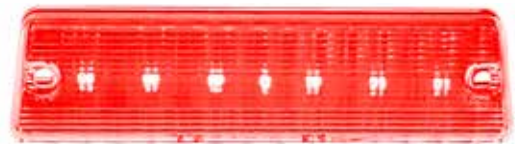

**LED LIGHTS**  
**C10 CHEVY TRUCK**

1969-72 Chevy & GMC Truck

**LED Cargo Light Assembly**

- Super bright LED cargo light assembly with integrated LED 3rd brake light
- High quality heavy chrome plated die-cast housing
- Includes large rubber mounting pad, socket, lens gasket, lens screws and housing to cab mounting spacers

Item Number	LEDs	Lens	Package	Pack
110147	White/Red	Clear	Carded	1 Pc./Card



1968-72 Chevy Truck

**18 LED Side Marker Light W/ Stainless Steel Trim**

- 18 super bright LEDs with high quality polycarbonate lens
- Dual function, parking light and turn signal
- Identical to the original with deluxe stainless trim
- Epoxy coated, fully sealed electronics, 1157 plug
- Easy wiring with hard wired 1157 double contact plug
- Energy efficient solid-state circuit board for 12V DC systems

Item Number	LEDs	Lens	Application	Pack
CML6872A	18 Amber	Amber	Side Marker	1 Pc./Card
CML6872R	18 Red	Red	Side Marker	1 Pc./Card



LED LIGHTS  
**1928-34 FORD**



**LED LIGHTS**  
**1928-32 FORD**

1928-31 Ford Model A

**LED Tail Light Lens W/ License Plate Light - 12V**

- Super bright LED with high quality polycarbonate lens
- Drivers side includes LED license plate illuminator lens on bottom
- Epoxy coated, fully sealed electronics, two 1156 plugs
- Energy efficient solid-state circuit board for 12V DC systems
- Recommend to upgrade under dash flasher to item # 90652 or 90649 LED flasher

Item Number	LEDs	Lens	Application	Pack
FTL2831LED-L	19 Red 4 White	Red/Clear	Driver License	1 Pc./Card
FTL2831LED-R	19 Red	Red	Passenger	1 Pc./Card
FTL2831RA-L	12 Amber 7 Red 4 White	Amber/ Red/Clear	Driver License	1 Pc./Card
FTL2831RA-R	12 Amber 7 Red	Amber/Red	Passenger	1 Pc./Card



1928-31 Ford Model A

**LED Tail Light Lens W/ License Plate Light- 6V**

- Super bright LEDs with high quality polycarbonate lens
- Drivers side includes LED license plate illuminator lens on bottom
- Epoxy coated, fully sealed electronics, 1156 plug
- Energy efficient solid-state circuit board for 6V DC systems
- Recommend 6V flasher item # 110252, and load resistor kit 34235

Item Number	LEDs	Lens	Application	Pack
FTL2831LED6-L	19 Red 4 White	Red/Clear	Driver License	1 Pc./Card
FTL2831LED6-R	19 Red	Red	Passenger	1 Pc./Card
FTL2831RA6-L	12 Amber 7 Red 4 White	Amber/ Red/Clear	Driver License	1 Pc./Card
FTL2831RA6-R	12 Amber 7 Red	Amber/Red	Passenger	1 Pc./Card



1928-31 Ford Model A

**LED Tail Light W/ Stainless Steel Housing - 12V**

- Super bright LEDs with high quality polycarbonate lens
- Complete with polished stainless steel housing and bezel
- Drivers side includes LED license plate illuminator lens on bottom
- Epoxy coated, fully sealed electronics, 1156 plug
- Energy efficient solid-state circuit board for 12V DC systems
- Recommend to upgrade under dash flasher to item # 90652 or 90649 LED flasher

Item Number	LEDs	Lens	Application	Pack
FTL2831LED-AL	19 Red 4 White	Red/Clear	Driver License	1 Pc./Box
FTL2831LED-AR	19 Red	Red	Passenger	1 Pc./Box
FTL2831RA-AL	12 Amber 7 Red 4White	Amber/ Red/Clear	Driver License	1 Pc./Card
FTL2831RA-AR	12 Amber 7 Red	Amber/Red	Passenger	1 Pc./Box



1928-31 Ford Model A

**LED Tail Light W/ Stainless Steel Housing - 6V**

- Super bright LEDs with high quality polycarbonate lens
- Complete with polished stainless steel housing and bezel
- Drivers side includes LED license plate illuminator lens on bottom
- Epoxy coated, fully sealed electronics
- Energy efficient solid-state circuit board for 6V DC systems
- Recommend 6V flasher item # 110252, and load resistor kit 34235

Item Number	LEDs	Lens	Application	Pack
FTL2831LED6-AL	19 Red 4 White	Red/Clear	Driver License	1 Pc./Box
FTL2831LED6-AR	19 Red	Red	Passenger	1 Pc./Box
FTL2831RA6-AL	12 Amber 7 Red 4White	Amber/Red/ Clear	Driver License	1 Pc./Box
FTL2831RA6-AR	12 Amber 7 Red	Amber/Red	Passenger	1 Pc./Box



1928-31 Ford Model A

**LED Tail Light W/ Black Housing - 12V**

- Super bright LEDs with high quality polycarbonate lens
- Drivers side includes LED license plate illuminator lens on bottom
- Gloss black powder coated housing w/ polished stainless steel rim
- Epoxy coated, fully sealed electronics
- Energy efficient solid-state circuit board for 12V DC systems
- Recommend to upgrade under dash flasher to item # 90652 or 90649 LED flasher

Item Number	LEDs	Lens	Application	Pack
<b>FTL2831LED-BAL</b>	19 Red 4 White	Red/Clear	Driver License	1 Pc./Box
<b>FTL2831LED-BAR</b>	19 Red	Red	Passenger	1 Pc./Box
<b>FTL2831RA-BAL</b>	12 Amber 7 Red 4 White	Amber/ Red/Clear	Driver License	1 Pc./Box
<b>FTL2831RA-BAR</b>	12 Amber 7 Red	Amber/Red	Passenger	1 Pc./Box



1928-31 Ford Model A

**LED Tail Light W/ Black Housing - 6V**

- Super bright LEDs with high quality polycarbonate lens
- Drivers side includes LED license plate illuminator lens on bottom
- Gloss black powder coated housing w/ polished stainless steel rim
- Epoxy coated, fully sealed electronics
- Energy efficient solid-state circuit board for 6V DC systems
- Recommend 6V flasher item # 110252, and load resistor kit 34235

Item Number	LEDs	Lens	Application	Pack
<b>FTL2831LED6-BAL</b>	19 Red 4 White	Red/Clear	Driver License	1 Pc./Box
<b>FTL2831LED6-BAR</b>	19 Red	Red	Passenger	1 Pc./Box
<b>FTL2831RA6-BAL</b>	12 Amber 7 Red 4 White	Amber/ Red/Clear	Driver License	1 Pc./Box
<b>FTL2831RA6-BAR</b>	12 Amber 7 Red	Amber/Red	Passenger	1 Pc./Box



1928-31 Ford Model A

**LED Tail Light With LED Blue Dot - 12V**

- Super bright LEDs with high quality polycarbonate lens
- Unique center blue dot lens with chrome ring
- Drivers side includes LED license plate illuminator lens on bottom
- Blue dot can be controlled independently with additional wiring
- Epoxy coated, fully sealed electronics
- Energy efficient solid-state circuit board for 12V DC systems
- Recommend to upgrade under dash flasher to item # 90652 or 90649 LED flasher

Item Number	LEDs	Lens	Application	Pack
<b>FTL2831BD-L</b>	21 Red 4 White	Red/Clear	Driver License	1 Pc./Box
<b>FTL2831BD-R</b>	21 Red	Red	Passenger	1 Pc./Box



1928-31 Ford Model A

**LED Tail Light With LED Blue Dot - 12V**

- Super bright LEDs with high quality polycarbonate lens
- Drivers side includes LED license plate illuminator lens on bottom
- Blue dot can be controlled independently with additional wiring
- Epoxy coated, fully sealed electronics
- Energy efficient solid-state circuit board for 12V DC systems
- Recommend to upgrade under dash flasher to item # 90652 or 90649 LED flasher

Item Number	LEDs	Lens	Application	Housing
<b>FTL2831BD-AL</b>	21 Red 4 White	Red/Clear	Driver License	Stainless
<b>FTL2831BD-AR</b>	21 Red	Red	Passenger	Stainless
<b>FTL2831BD-BAL</b>	21 Red 4 White	Red/Clear	Driver License	Black
<b>FTL2831BD-BAR</b>	21 Red	Red	Passenger	Black



**LED LIGHTS**  
**1928-32 FORD**

1928-31 Ford Car

**31 LED Sequential Tail Light W/ Black Housing SS Rim**

- 31 super bright LEDs behind high quality red acrylic lens
- 4 additional white LEDs with clear lens for license plate light
- Selector switch to control sequential function off, direction left, or direction right
- Also features brake attention option with sequence-once function
- Electronics sealed in epoxy to resist corrosion and moisture
- Energy efficient solid-state circuit board for 12V DC systems
- Recommend to upgrade under dash flasher to item # 90652 (2-terminal) or 90651 (3-terminal) LED flasher

Item Number	LEDs	Lens	Application	Pack
110894	31 Red 4 White	Red/Clear	Driver Side	1 Pc./Box
110895	31 Red	Red	Passenger Side	1 Pc./Box

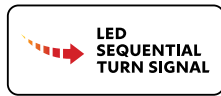

1928-31 Ford Model "A"

**31 LED Sequential Tail Light W/ Stainless Housing & Rim**

- 31 bright LED sequential tail light w/ stainless steel housing & rim
- 4 additional white LEDs with clear lens for license plate light
- Selector switch to control sequential function off, direction left, or direction right
- Also features brake attention option with sequence-once function
- Electronics sealed in epoxy to resist corrosion and moisture
- Energy efficient solid-state circuit board for 12V DC systems
- Recommend to upgrade under dash flasher to item # 90652 (2-terminal) or 90651 (3-terminal) LED flasher

Item Number	LEDs	Lens	Application	Pack
110890	31 Red 4 White	Red/Clear	Driver Side	1 Pc./Box
110891	31 Red	Red	Passenger Side	1 Pc./Box

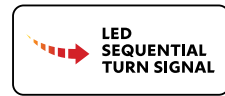

1928-31 Ford Car

**31 LED Sequential Tail Light W/ Black Housing & Rim**

- 31 super bright LED sequential tail light w/ black housing & rim
- 4 additional white LEDs with clear lens for license plate light
- Selector switch to control sequential function off, direction left, or direction right
- Also features brake attention option with sequence-once function
- Electronics sealed in epoxy to resist corrosion and moisture
- Energy efficient solid-state circuit board for 12V DC systems
- Recommend to upgrade under dash flasher to item # 90652 (2-terminal) or 90651 (3-terminal) LED flasher

Item Number	LEDs	Lens	Application	Pack
110892	31 Red 4 White	Red/Clear	Driver Side	1 Pc./Box
110893	31 Red	Red	Passenger Side	1 Pc./Box

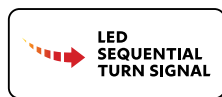

1928-31 Ford Car

**19 LED Tail Light - Stainless Steel Housing & Rim**

- 19 super bright LEDs with polished stainless steel housing & rim
- 4 additional white LEDs with clear lens for license plate light
- Electronics sealed in epoxy to resist corrosion and moisture
- Energy efficient solid-state circuit board for 12V DC systems
- Recommend to upgrade under dash flasher to item # 90652 (2-terminal) or 90651 (3-terminal) LED flasher

Item Number	LEDs	Lens	Application	Pack
<b>FTL2831LED-AL</b>	19 Red 4 White	Red/Clear	Driver Side	1 Pc./Box
<b>FTL2831LED-AR</b>	19 Red	Red	Passenger Side	1 Pc./Box



1928-31 Ford Model "A"

**LED Tail Light W/ Black Housing & Blue Dot Lens**

- Super bright red LEDs w/ gloss black powder coated housing & rim
- 4 additional white LEDs with clear lens for license plate light
- Blue dot with chrome plated ring looks exactly as original
- Blue dot can be controlled independently with additional wiring
- Electronics sealed in epoxy to resist corrosion and moisture
- Energy efficient solid-state circuit board for 12V DC systems
- Recommend to upgrade under dash flasher to item # 90652 (2-terminal) or 90651 (3-terminal) LED flasher

Item Number	LEDs	Lens	Application	Pack
<b>FTL2831BD-MAL</b>	19 Red 4 White	Red/Clear	Driver Side	1 Pc./Box
<b>FTL2831BD-MAR</b>	19 Red	Red	Passenger Side	1 Pc./Box



1932 Ford Car & Truck

**31 LED Sequential Tail Light W/ Stainless Housing & Rim**

- 31 super bright LED sequential tail light w/ highly polished stainless steel housing & rim
- 4 additional white LEDs with clear lens for license plate light
- Selector switch to control sequential function off, direction left, or direction right
- Also features brake attention option with sequence-once function
- Electronics sealed in epoxy to resist corrosion and moisture
- Energy efficient solid-state circuit board for 12V DC systems
- Recommend to upgrade under dash flasher to item # 90652 or 90649 LED flasher

Item Number	LEDs	Lens	Application	Pack
<b>110873</b>	31 Red	Red	Driver	1 Pc./Box
<b>110872</b>	31 Red	Red	Passenger	1 Pc./Box

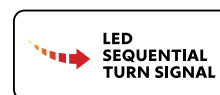

**LED LIGHTS**  
**1928-34 FORD**

**Ford LED Cowl Light**

- Ford LED cowl light, dual function, parking light and turn signal light
- Hardwired with 3 wires, 1 wire with ring terminal, 12V
- Solid state circuit boards are designed for 7.7 - 14.0 VDC

*Fits 1928-1929 Ford*

Item Number	LEDs	Lens	Application	Pack
<b>FPL2829LED</b>	22 Amber	Clear	Carded	1 Pc./Card

*Fits 1930-1931 Ford*

Item Number	LEDs	Lens	Application	Pack
<b>FPL3031LED</b>	17 Amber	Clear	Carded	1 Pc./Card

*Fits 1932 Ford*

Item Number	LEDs	Lens	Application	Pack
<b>FPL3232LED</b>	15 Amber	Clear	Carded	1 Pc./Card

*Fits 1933-1934 Ford*

Item Number	LEDs	Lens	Application	Pack
<b>FPL3334LED</b>	13 Amber	Clear	Carded	1 Pc./Card



FPL2829LED - 1928-29 Ford



FPL3031LED - 1930-31 Ford



FPL23232LED - 1932 Ford



FPL3334LED - 1933-34 Ford

Directly Fits All 1928 - 1934 Ford Cowl Lamps



*1932 Ford Car & Truck*

**Polished Stainless Steel Spreader Bar w/ LED Turn Signals**

- Highly polished stainless steel with hidden welds
- Wires exit on each side near mounting flange and can be easily hidden along inside frame rail
- Flush mounted amber lens LED lights
- Each light strip has 10 super bright amber LED lights to function as turn signal light
- High quality polycarbonate lens with epoxy coated fully sealed 12V DC solid state circuit boards
- Recommend to upgrade under dash flasher to item # 90652 or 90649 LED flasher

Item Number	LEDs	Lens	Application	Pack
<b>F3201LED</b>	5 Amber x 2	Amber	Spreader	1 Pc./Box

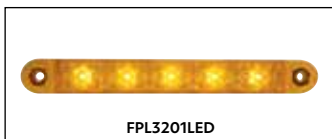
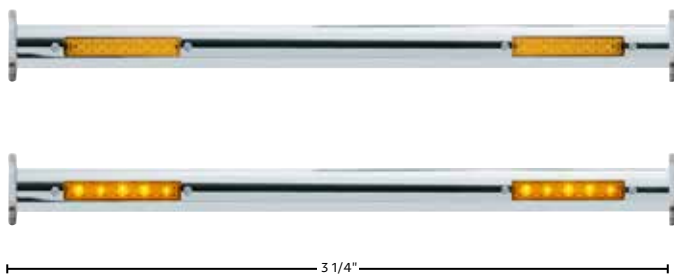

*1933-34 Ford Car & Truck*

**SS Front V-Shape Spreader Bar With LED**

- Highly polished stainless steel with hidden welds
- Wires exit on each side near mounting flange and can be easily hidden along inside frame rail
- Flush mounted amber lens LED lights
- Each light strip has 10 super bright amber LED light to function as turn signal light
- High quality polycarbonate lens with epoxy coated fully sealed 12V DC solid state circuit boards
- Recommend to upgrade under dash flasher to item # 90652 or 90649 LED flasher

Item Number	LEDs	Lens	Application	Pack
<b>F3301-LED</b>	5 Amber x 2	Amber	Spreader	1 Pc./Box

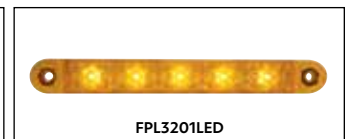
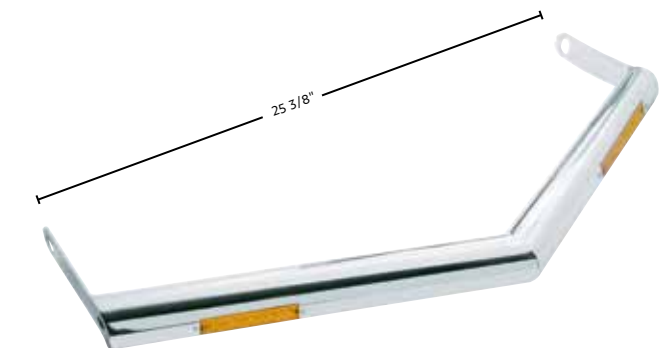



1928-31 Ford Car

**31 LED Sequential Tail Light**

- 31 bright LEDs, driver side includes a 4 white LED license light
- Selector switch to control sequential function off, direction left, or direction right
- Also features brake attention with a sequence-once function
- Epoxy coated, fully sealed electronics, two 1156 plugs
- Recommend to upgrade under dash flasher to item # 90652 or 90649 LED flasher
- DOT & SAE FMVSS108. Not for use w/early 1928 "AR" drum tail lights

Item Number	LEDs	Lens	Application	Pack
110194	31 Red/4 Wht.	Red/Clear	Driver	1 Pc./Card
110195	31 Red	Red	Passenger	1 Pc./Card



1932 Ford Car & Truck

**34 LED Sequential Tail Light**

- 34 bright LEDs, driver side includes a 4 white LED license light
- Selector switch to control sequential function off, direction left, or direction right
- Also features brake attention with a sequence-once function
- Epoxy coated, fully sealed electronics, two 1156 plugs
- Energy efficient solid-state circuit board for 12VDC systems
- Recommend to upgrade under dash flasher to item # 90652 or 90649 LED flasher

Item Number	LEDs	Lens	Application	Pack
110196	34 Red/4 Wht.	Red/Clear	Driver	1 Pc./Card
110197	34 Red	Red	Passenger	1 Pc./Card



1932 Ford Car & Truck

**17 LED Tail Light Lens**

- 17 super bright LEDs, driver side includes a 4 white LED license light
- Epoxy coated, fully sealed electronics, two 1156 plugs
- Solid state circuit boards are designed for 7.7 - 14.0 VDC

Item Number	LEDs	Lens	Application	Pack
FTL3201LED-L	17 Red/4 Wht.	Red/Clear	Driver	1 Pc./Card
FTL3201LED-R	17 Red	Red	Passenger	1 Pc./Card

**LED LIGHTS**  
**1930s-40s FORD**

1932 Ford Car & Truck

**17 LED Tail Light Assembly W/ Stainless Housing**

- 17 super bright LEDs with high quality polycarbonate lens
- Complete with polished stainless steel housing and bezel
- Includes bright LED license plate illuminator lens on bottom
- Electronics sealed in epoxy to resist corrosion and moisture
- Energy efficient solid-state circuit board for 12V DC systems
- Recommend to upgrade under dash flasher to item # 90652 or 90649 LED flasher

Item Number	LEDs	Lens	Application	Pack
FTL3201LED-AL	17 Red/4 Wht.	Red/Clear	Driver	1 Pc./Box
FTL3201LED-AR	17 Red	Red	Passenger	1 Pc./Box



1933-36 Ford Car & Truck

**21 LED Tail Light Assembly**

- 21 super bright LEDs with high quality polycarbonate lens
- Polished stainless steel housing
- Includes bright LED license plate illuminator lens on bottom
- Epoxy coated, fully sealed electronics
- Easy wiring with hard wired 1157 double contact plug
- Recommend to upgrade under dash flasher to item # 90652 or 90649 LED flasher

Item Number	LEDs	Lens	Application	Housing
FTL3336LED-AL	17 Red 4 White	Red/Clear	Driver License	Stainless
FTL3336LED-AR	17 Red	Red	Passenger	Stainless
FTL3336LED-ALB	17 Red 4 White	Red/Clear	Driver License	Black
FTL3336LED-ARB	17 Red	Red	Passenger	Black



1933-36 Ford Car & Truck

**19 LED Tail Light Assembly - Glass Lens**

- 19 super bright LEDs with high quality polycarbonate lens
- Epoxy coated, fully sealed electronics
- Solid-state circuit board engineered for 12V DC systems
- Recommend to upgrade under dash flasher to item # 90652 or 90649 LED flasher

Item Number	LEDs	Lens	Application	Housing
FTL3336L	19 Red 5 White	Red/Clear	Driver License	Stainless
FTL3336R	19 Red	Red	Passenger	Stainless
FTL3336L-BK	19 Red 5 White	Red/Clear	Driver License	Black
FTL3336R-BK	19 Red	Red	Passenger	Black



*1933-36 Ford Truck*

**17 LED Tail Light With Chrome Grille Bezel**

- Great for hot rods, rat rods, and motorcycles
- Chrome plated die-cast metal grille bezel protects tail light lens
- Includes LED license plate illuminator with lens
- Solid-state circuit board engineered for 12V DC systems

Item Number	LEDs	Lens	Application	Pack
<b>110660</b>	17 Red 4 White	Red	Driver License	1 Pc./Card
<b>110661</b>	17 Red	Red	Passenger	1 Pc./Card



*1937 Ford Car*

**17 LED Tail Light W/Chrome Grille Bezel Flush Mount Style**

- 17 super bright red LEDs with chrome flush mount bezel
- Light is 3-3/4" dia. and 3/4" tall
- Mounting studs are approximately 3-7/16" apart
- Recommend to upgrade under dash flasher to item # 90652 or 90649 LED flasher

Item Number	LEDs	Lens	Application	Pack
<b>110407</b>	17 Red	Red	Tail light	1 Pc./Card



*1933-36 Ford Truck*

**17 LED Tail Light W/ Black Grille Bezel**

- Great for hot rods, rat rods, and motorcycles
- Gloss black powder coated metal grille bezel protects tail light lens
- High quality polycarbonate all red lens
- Includes LED license plate illuminator with lens
- Solid-state circuit board engineered for 12V DC systems

Item Number	LEDs	Lens	Application	Pack
<b>110662</b>	17 Red 4 White	Red	Driver License	1 Pc./Card
<b>110663</b>	17 Red	Red	Passenger	1 Pc./Card



*1937 Ford Car*

**17 LED Tail Light W/Black Grille Bezel Flush Mount Style**

- 17 super bright red LEDs with black powder coated flush mount bezel
- Light is 3-3/4" dia. and 3/4" tall
- Mounting studs are approximately 3-7/16" apart
- Recommend to upgrade under dash flasher to item # 90652 or 90649 LED flasher

Item Number	LEDs	Lens	Application	Pack
<b>110409</b>	17 Red	Red	Tail light	1 Pc./Card



*1933-36 Ford Car & Truck*

**21 LED Tail Light**

- 21 super bright LEDs with injection molded polycarbonate lens
- Includes bright LED license plate illuminator lens on bottom
- Epoxy coated, fully sealed electronics, 1157 plug
- Solid-state circuit board engineered for 12V DC systems
- Recommend to upgrade under dash flasher to item # 90652 or 90649 LED flasher

Item Number	LEDs	Lens	Application	Pack
<b>FTL3336LED-L</b>	17 Red 4 White	Red/Clear	Driver License	1 Pc./Card
<b>FTL3336LED-R</b>	17 Red	Red	Passenger	1 Pc./Card

**LED LIGHTS**  
**1930s-40s FORD**

*1937 Ford Car & Truck*

**17 LED Tail Light Lens**

- 17 super bright LED with high quality polycarbonate lens
- Includes bright LED license plate illuminator lens on bottom
- Epoxy coated, fully sealed electronics, 1157 plug
- Energy efficient solid-state circuit board for 12V DC systems
- Recommend to upgrade under dash flasher to item # 90652 or 90649 LED flasher

Item Number	LEDs	Lens	Application	Pack
<b>FTL3701LED-L</b>	17 Red 8 White	Red/Clear	Driver License	1 Pc./Card
<b>FTL3701LED-R</b>	17 Red	Red	Passenger	1 Pc./Card



*1937 Ford Car & Truck*

**17 LED Tail Light**

- 17 super bright LED with high quality polycarbonate lens
- Beautiful chrome plated housing and polished stainless steel rim
- Epoxy coated, fully sealed electronics
- Energy efficient solid-state circuit board for 12V DC systems
- Recommend to upgrade under dash flasher to item # 90652 or 90649 LED flasher

Item Number	LEDs	Lens	Application	Pack
<b>FTL3711RC</b>	17 Red	Red	Passenger	Chrome
<b>FTL3711R</b>	17 Red	Red	Passenger	Black



*1933-36 Ford Car & Truck*

**19 LED Tail Light Retrofit**

- 19 super bright LEDs with high quality polycarbonate lens
- Epoxy coated, fully sealed electronics
- Solid-state circuit board engineered for 12V DC systems
- Recommend to upgrade under dash flasher to item # 90652 or 90649 LED flasher

Item Number	LEDs	Lens	Application	Pack
<b>FTL3336CB-L</b>	19 Red 5 White	Red/Clear	Driver License	1 Pc./Card
<b>FTL3336CB-R</b>	19 Red	Red	Passenger	1 Pc./Card



*1933-36 Ford Car & Truck*

**21 LED Tail Light With Smoke Lens**

- 21 super bright LEDs with high quality polycarbonate lens
- Includes 4 bright white LED license light
- Epoxy coated, fully sealed electronics, 1157 plug
- Solid-state circuit board engineered for 12V DC systems
- Recommend to upgrade under dash flasher to item # 90652 or 90649 LED flasher

Item Number	LEDs	Lens	Application	Pack
<b>110150</b>	21 Red 4 White	Clear	Driver License	1 Pc./Card



1938-39 Ford Car

**33 LED Tail Light Lens**

- 33 super bright LED tail light with red polycarbonate lens
- Dual function with parking light and bright turn signal
- Lens fits all original & reproduction 1938-39 Ford tail lights
- Easy electrical connection w/ 1157 plug, no modification to vehicle
- Fits L/H or R/H side
- Recommend to upgrade under dash flasher to item # 90652 (2-terminal or 90651 (3-terminal)

Item Number	LEDs	Lens	Package	Pack
<b>FTL3839NTLED</b>	33 Red	Red	Carded	1 Pc./Card



1938-39 Ford Car

**33 LED Tail Light W/ Stainless Steel Rim**

- 33 super bright LED tail light with red polycarbonate lens
- Dual function with tail light & bright stop/turn signal
- Epoxy coated, fully sealed electronics, 1157 plug
- Original style black tail lamp housing with stainless steel rim
- Rubber mounting pad sold separately, item # A9009
- Recommend to upgrade under dash flasher to item # 90652 or 90649 LED

Item Number	LEDs	Lens	Package	Pack
<b>F383904</b>	33 Red	Red	Boxed	1 Pc./Box



1938-39 Ford Car

**33 LED Tail Light W/ Chrome Flush Mount Bezel**

- 33 super bright LED tail light with red polycarbonate lens
- Dual function with tail light and bright stop/turn signal
- Die-cast chrome plated bezel, mounts to flat surface with 2 small studs, fits L/H or R/H side
- Epoxy coated, fully sealed electronics, 1157 plug
- Rubber mounting pad sold separately, item # FTL3839-1
- Recommend to upgrade under dash flasher to item # 90652 or 90649 LED

Item Number	LEDs	Lens	Package	Pack
<b>FTL383907</b>	33 Red	Red	Carded	1 Pc./Card



1938-39 Ford Car

**28 LED Tail light With Glass Lens**

- 28 super bright red LED behind glass lens
- Epoxy coated, fully sealed electronics
- Includes stainless steel rim and black housing
- Recommend to upgrade under dash flasher item # 90652 or 90649 LED flasher

Item Number	LEDs	Lens	Package	Pack
<b>A1060LED</b>	28 Red	Red	Carded	1 Pc./Box



**LED LIGHTS**  
**1930s-40s FORD**

1938-39 Ford Car

**51 LED Tail Light**

- 51 super bright red LEDs w/ high quality polycarbonate lens
- Epoxy coated, fully sealed electronics
- Easy electrical connection w/ 1157 plug, no modification to vehicle
- Energy efficient solid-state circuit board for 12V DC systems
- Recommend to upgrade under dash flasher to item # 90652 or 90649 LED

Item Number	LEDs	Lens	Package	Pack
<b>FTL3839LED</b>	51 Red	Red	Carded	1 Pc./Card



1938-39 Ford Car

**51 LED Tail Light With Stainless Steel Rim**

- 51 super bright red LEDs w/ high quality polycarbonate lens
- Epoxy coated, fully sealed electronics
- Includes stainless steel rim and black housing
- Energy efficient solid-state circuit board for 12V DC systems
- Recommend to upgrade under dash flasher to item # 90652 or 90649 LED

Item Number	LEDs	Lens	Package	Pack
<b>F383901</b>	51 Red	Red	Carded	1 Pc./Card



1938-39 Ford Passenger Car

**19 LED Sequential Tail Light Lens**

- 19 super bright red LED sequential tail light
- Selector switch to control sequential function off, direction left, or direction right
- Also features brake attention option with sequence-once function
- Epoxy coated, fully sealed electronics, 1157 plug
- Recommend to upgrade under dash flasher to item # 90652 or 90649 LED
- Fits United Pacific chrome teardrop bezel: item # 34024B and flame bezel item # 34025B, DOT/SAE approved

Item Number	LEDs	Lens	Package	Pack
<b>110253</b>	19 Red	Red	Carded	1 Pc./Card

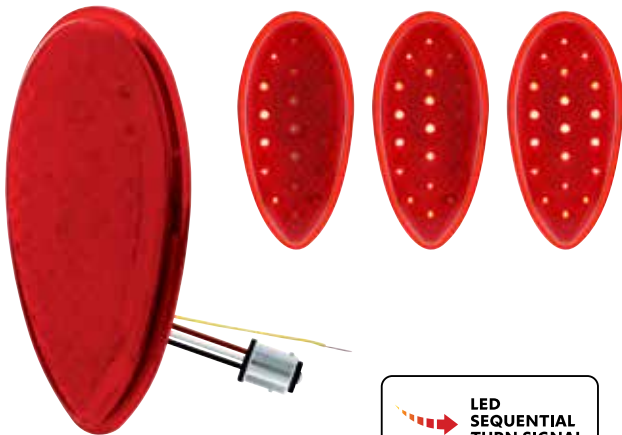

1938-39 Ford Car

**19 LED Sequential Tail Light Assembly**

- 19 super bright red LED sequential tail light
- Black powder coated housing, stainless steel rim
- Selector switch to control sequential function off, direction left, or direction right
- Also features brake attention option with sequence-once function
- Epoxy coated, fully sealed electronics, 1157 plug
- Recommend to upgrade under dash flasher to item # 90652 or 90649 LED

Item Number	LEDs	Lens	Package	Pack
<b>110796</b>	19 Red	Red	Carded	1 Pc./Card

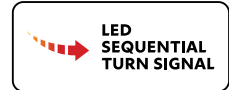
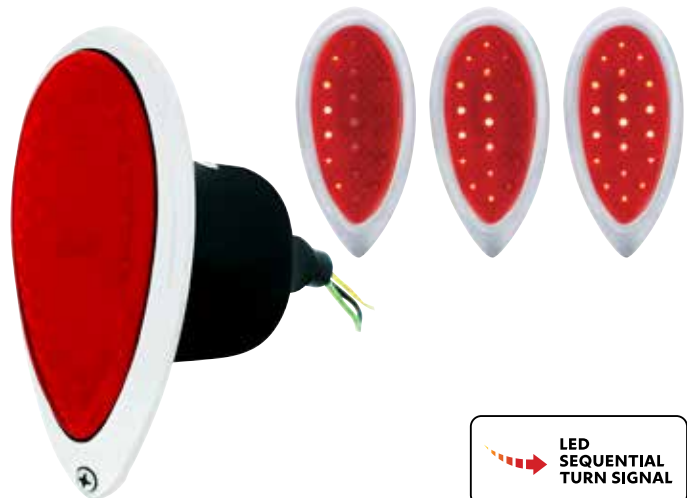

1938-39 Ford Car

**19 LED Sequential Tail Light w/Chrome Bezel - Flush Mount**

- 19 bright LED sequential tail light with chrome flush mount bezel
- Selector switch to control sequential function off, direction left, or direction right
- Also features brake attention option with sequence-once function
- Epoxy coated, fully sealed electronics, 1157 plug
- Chrome plastic flame bezel, mounts with 2 small studs
- Recommend to upgrade under dash flasher to item # 90652 or 90649 LED

Item Number	LEDs	Lens	Package	Pack
<b>110797</b>	19 Red	Red	Carded	1 Pc./Card

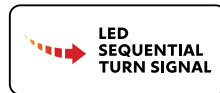
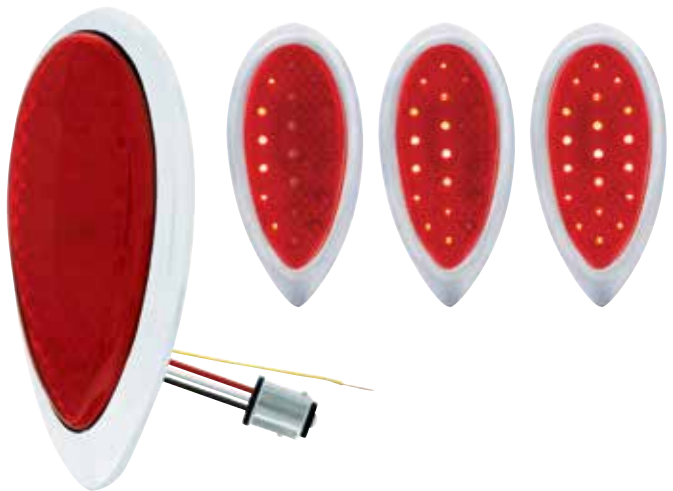

1938-39 Ford Car

**39 LED Tail Light W/ Flush Mount Chrome Bezel**

- 39 super bright LEDs w/ high quality polycarbonate lens
- Die-cast chrome plated bezel mounts to flat surface w/ 2 small studs
- Epoxy coated, fully sealed electronics, 1157 plug
- Energy efficient solid-state circuit board for 12V DC systems
- Mounting pad sold separately item # FTL3839-1
- Recommend to upgrade under dash flasher to item # 90652 or 90649 LED

Item Number	LEDs	Lens	Housing	Pack
<b>FTL383903</b>	39 Red	Red	Chrome	1 Pc./Card



1938-39 Ford Car

**37 LED Tail Light W/ Stainless Steel Bezel**

- 37 super bright LED tail light with high quality polycarbonate lens
- Stainless steel rim and black original style housing
- Epoxy coated, fully sealed electronics, 1157 plug
- Recommend to upgrade under dash flasher to item # 90652 or 90649 LED
- Mounting pad item # A9009 sold separately

Item Number	LEDs	Lens	Housing	Pack
<b>F383905</b>	37 Red/14 Amber	Clear	Chrome	1 Pc./Card



1938-39 Ford Car

**37 LED Tail Light W/ Stainless Steel Bezel**

- 37 super bright LED tail light w/ high quality polycarbonate lens
- High quality injection molded polycarbonate lens
- Epoxy coated, fully sealed electronics
- Easy electrical connection w/ 1157 plug, no modification to vehicle
- Recommend to upgrade under dash flasher to item # 90652 or 90649 LED

Item Number	LEDs	Lens	Housing	Pack
<b>FTL383905ZR</b>	37 Red/14 Amber	Clear	Chrome	1 Pc./Card



**LED LIGHTS**  
**1930s-40s FORD**

1938-39 Ford Car

**51 LED Tail Light W/Flush Mount "Baby Zephyr" Bezel**

- 51 super bright LED tail light with high quality polycarbonate lens
- Baby Zephyr style bezel with over-the-lens cross bar
- Die-cast chrome plated bezel mounts to flat surface w/ 2 small studs
- Epoxy coated, fully sealed electronics, 1157 plug
- Energy efficient solid-state circuit board for 12V DC systems
- Recommend to upgrade under dash flasher to item # 90652 or 90649 LED

Item Number	LEDs	Lens	Housing	Pack
<b>FTL383903ZR</b>	51 Red/14 Amber	Clear	Chrome	1 Pc./Card



1938-39 Ford Car

**33 LED Tail Light Lens - Original Style**

- 33 super bright LED tail light with red polycarbonate lens
- New LED lens design is the same size and shape as original Ford lens
- Dual function with tail light and bright turn signal
- Blue dot can be controlled independently with additional wiring
- Lens fits all original & reproduction 1938-39 Ford tail lights
- Easy wiring with hard wired 1157 double contact plug, no modification to vehicle, fits L/H or R/H side
- Recommend to upgrade under dash flasher to item # 90652 or 90649 LED

Item Number	LEDs	Lens	Package	Pack
<b>FTL3839NT-BD</b>	33 Red	Red	Carded	1 Pc./Card



1938-39 Ford Car

**33 LED Tail Light W/Blue Dot Lens & Stainless Steel Bezel**

- 33 super bright LED tail light with red polycarbonate lens
- Blue dot with chrome plated rim looks exactly as original
- Stamped steel housing with polished stainless rim
- Dual function with tail light and bright turn signal
- Blue dot can be controlled independently with additional wiring
- Rubber mounting pad sold separately, item # A9009
- Recommend to upgrade under dash flasher to item # 90652 or 90649 LED

Item Number	LEDs	Lens	Package	Pack
<b>F383904BD</b>	33 Red	Red	Carded	1 Pc./Card



1938-39 Ford Car

**33 LED Tail Light W/ Chrome Bezel & Blue Dot, Flush Mount**

- 33 super bright LED flush mount tail light with polycarbonate lens
- Blue dot with chrome plated rim looks exactly as original
- Dual function with tail light and bright turn signal
- Blue dot can be controlled independently with additional wiring
- Die-cast chrome plated bezel, mounts to flat surface with 2 studs
- Epoxy coated, fully sealed electronics, 1157 plug
- Recommend to upgrade under dash flasher to item # 90652 or 90649 LED

Item Number	LEDs	Lens	Package	Pack
<b>FTL383908</b>	33 Red	Red	Carded	1 Pc./Card





1938-39 Ford Car

**LED Tail Light w/ Chrome Bezel**

- 37 super bright LED tail light with dual color polycarbonate lens
- Chrome flush mount "Teardrop" style bezel
- Epoxy coated, fully sealed electronics, 1157 plug
- Recommend to upgrade under dash flasher to item # 90652 or 90649 LED

Item Number	LEDs	Lens	Housing	Pack
<b>38812</b>	39 Red	Red	Chrome	1 Pc./Card



1938-39 Ford Car

**33 LED Tail Light w/ Chrome Flame Flush Mount Bezel**

- New LED lens design is the same size and shape as original Ford lens
- Super bright LED with high quality injection molded polycarbonate lens
- Dual function with tail light & bright stop/turn signal
- Epoxy coated, fully sealed electronics, 1157 plug
- Recommend to upgrade under dash flasher to item # 90652 or 90649 LED

Item Number	LEDs	Lens	Package	Pack
<b>FTL383909</b>	33 Red	Red	Carded	1 Pc./Card



1938-39 Ford Car

**19 LED Sequential Tail Light w/Chrome Flame Bezel**

- Chrome plated flush mount flame light bezel
- Selector switch to control sequential function off, direction left, or direction right
- Also features brake attention option with sequence-once function
- Epoxy coated, fully sealed electronics, 1157 plug
- Recommend to upgrade under dash flasher to item # 90652 or 90649 LED

Item Number	LEDs	Lens	Package	Pack
<b>110798</b>	19 Red	Red	Carded	1 Pc./Card

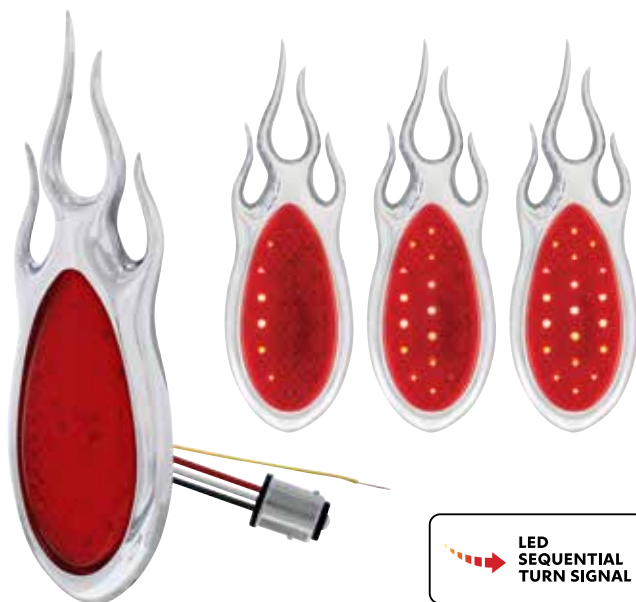

1938-39 Ford Car

**33 LED Tail Light w/ Chrome Flame**

- New lens design is the same size and shape as original Ford lens
- Super bright LED with high quality polycarbonate lens
- Dual function with tail light & bright stop/turn signal
- Epoxy coated, fully sealed electronics, 1157 plug
- Recommend to upgrade under dash flasher to item # 90652 or 90649 LED

Item Number	LEDs	Lens	Package	Pack
<b>FTL383910</b>	33 Red	Red	Carded	1 Pc./Card



**LED LIGHTS**  
**1930s-40s FORD**



Fits in place of original lens

*1940 Ford Car & 1940-41 Ford Truck*

**21 LED Front Turn Signal**

- Super bright LED turn signal with high quality injection molded polycarbonate lens
- 3 mounting clips included with package
- Epoxy coated, fully sealed electronics
- Energy efficient solid-state circuit board for 12V DC systems

Item Number	LEDs	Lens	Housing	Pack
<b>FPL4001LED</b>	12 Amber	Clear	Chrome	1 Pc./Card
<b>FPL4002LED</b>	12 Amber 9 White	Clear	Chrome	1 Pc./Card



*1940 Ford Car*

**24 LED Tail Light w/ Chrome Flush Mount Bezel**

- New chrome bezel and lens is exactly same size & shape as original
- Fits all 1940 Ford standard & deluxe passenger cars
- Mounts on surface of stock fender with 3 small studs, requires drilling 2 small holes behind the light
- Mounts on fender with 3 small studs, requires drilling 2 small holes behind the light
- If using new fenders, no need to cut the large original tail light hole
- Super bright LED complete with red polycarbonate lens
- Dual function with tail light & bright stop/turn signal
- Includes chrome bezel rubber pad and mounting studs
- LED compatible flasher required for proper operation, item #90652 or 90649

Item Number	LEDs	Lens	Package	Pack
<b>FTL4005LED</b>	24 Red	Red	Carded	1 Pc./Card





1940 Ford Car

**24 LED TAIL LIGHT ASSEMBLY WITH BLACK HOUSING & STAINLESS STEEL RIM**

- New lens design is exactly same size & shape as original lens
- Complete with stainless steel rim and black housing
- Epoxy coated, fully sealed electronics
- Mounts on fender with 3 small studs, requires drilling 2 small holes behind the light
- Energy efficient solid-state circuit board engineered for 12V DC systems
- Includes chrome bezel, rubber pad and mounting studs
- LED compatible flasher required for proper operation, item #90652 or 90649

Item Number	LEDs	Lens	Package	Pack
<b>FTL4014LED</b>	24 Red	Red	Carded	1 Pc./Card



1940 Ford Car

**24 LED Tail Light Lens**

- 24 super bright LED tail light lens with polycarbonate lens
- New lens design is exactly same size & shape as original lens
- Dual function with tail light & bright stop/turn signal
- Epoxy coated, fully sealed electronics, 1157 plug
- Recommend to upgrade under dash flasher to item # 90652 or 90649 LED

Item Number	LEDs	Lens	Package	Pack
<b>FTL4004LED</b>	24 Red	Red	Carded	1 Pc./Card



1940 Ford Car

**Chrome Tail Light Bezel and Mounting Pad**

- 1940 Ford chrome flush mount bezel for FTL4004LED
- 1940 flush mount rubber pad for original curved or flat fender

Item Number	LEDs	Pack
<b>FTL4004RB</b>	Chrome Tail light Bezel	1 Pc.
<b>FTL4004-2</b>	Curved Fender Flush Mount Rubber Pad	1 Pc.



**LED LIGHTS**  
**1940s-50s FORD**

1940 Ford Passenger Car

**20 LED Deluxe Tail Light**

- 20 super bright LED tail light lens with polycarbonate lens
- Epoxy coated, fully sealed electronics
- Easy wiring with hard wired 1157 double contact plug
- Energy efficient solid-state circuit board for 12V DC systems
- Recommend to upgrade under dash flasher to item # 90652 or 90649 LED
- Chrome bezel also available separately item # FT4003

Item Number	LEDs	Lens	Package	Pack
<b>FTL4006LED</b>	20 Red	Red	Carded	1 Pc./Card



1940 Ford Passenger Car

**20 LED Deluxe Tail Light**

- 20 super bright LED tail light lens with polycarbonate lens
- Complete with stainless steel rim and black housing
- Epoxy coated, fully sealed electronics
- Easy wiring with hard wired 1157 double contact plug
- Energy efficient solid-state circuit board for 12V DC systems
- Recommend to upgrade under dash flasher to item # 90652 or 90649 LED

Item Number	LEDs	Lens	Package	Pack
<b>FTL4011LED</b>	20 Red	Red	Carded	1 Pc./Card



1940 Ford Passenger Car

1948-56 Ford Panel Truck

1946-48 Sportsman

**21 LED Deluxe Tail Light**

- 21 super bright LED tail light lens with polycarbonate lens
- Epoxy coated, fully sealed electronics
- Easy wiring with hard wired 1157 double contact plug
- Energy efficient solid-state circuit board for 12V DC systems
- Recommend to upgrade under dash flasher to item # 90652 or 90649 LED

Item Number	LEDs	Lens	Package	Pack
<b>FTL4101LED</b>	21 Red	Red	Carded	1 Pc./Card



1941 Ford Car

**21 LED Tail Light w/ Chrome Bezel and Mounting Pad**

- 21 super bright LED tail light lens with polycarbonate lens
- Mounting studs are approximately 4-3/4" apart
- Epoxy coated, fully sealed electronics
- Easy wiring with hard wired 1157 double contact plug
- Energy efficient solid-state circuit board for 12V DC systems
- Recommend to upgrade under dash flasher to item # 90652 or 90649 LED
- Chrome bezel and mounting pad sold separately, item # FTL4101R & FTL4101-1

Item Number	LEDs	Lens	Package	Pack
<b>FTL414103</b>	21 Red	Red	Carded	1 Pc./Card



1941 Ford Car

**21 Super Bright LED Retrofit Tail Light Insert**

- 21 super bright LEDs with amber polycarbonate lens
- Beautiful die-cast chrome bezel
- Mounting studs are approximately 4-3/4" apart
- Epoxy coated, fully sealed electronics
- Energy efficient solid-state circuit board for 12V DC systems
- Chrome bezel and mounting pad sold separately, item # FTL4101R & FTL4101-1

Item Number	LEDs	Lens	Package	Pack
<b>FPL4111A</b>	21 Amber	Amber	Bulk	1 Pc./Card



1941 Ford

**21 Super Bright LED Retrofit Tail Light Insert**

- 21 super bright LEDs with amber polycarbonate lens
- Epoxy coated, fully sealed electronics
- Energy efficient solid-state circuit board for 12V DC systems

Item Number	LEDs	Lens	Package	Pack
<b>FPL4101A</b>	21 Amber	Amber	Bulk	1 Pc./Card

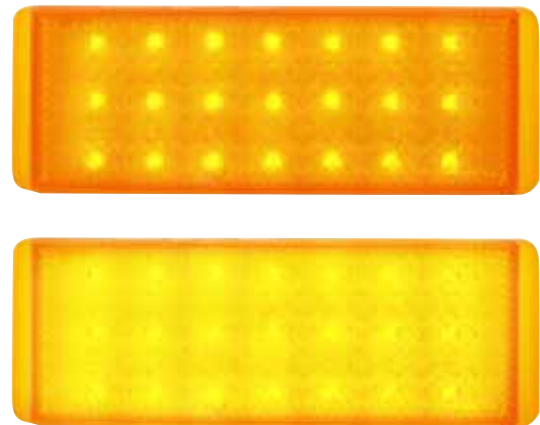

1942-48 Ford

**40 Super Bright LED Tail Light**

- 40 super bright LEDs with polycarbonate lens, stainless steel bezel and black housing
- Epoxy coated, fully sealed electronics, 1157 plug
- Solid state circuit boards are designed for 7.7 - 14.0 VDC

Item Number	LEDs	Lens	Package	Pack
<b>F42802</b>	40 Red	Red	Boxed	1 Pc./Box



1942-48 Ford

**40 Super Bright LED Tail Light**

- 40 super bright LEDs with polycarbonate lens
- Epoxy coated, fully sealed electronics, 1157 plug
- Solid state circuit boards are designed for 7.7 - 14.0 VDC

Item Number	LEDs	Lens	Package	Pack
<b>FTL4248LED</b>	40 Red	Red	Carded	1 Pc./Card



**LED LIGHTS**  
**1940s-50s FORD**

1942-48 Ford Car

**40 LED Chrome Die-cast Flush Mount Tail Light Assembly**

- 40 super bright LED tail light lens with polycarbonate lens, chrome die-cast rim and flush mount bezel
- Epoxy coated, fully sealed electronics
- Easy wiring with 1157 double contact plug
- Recommend to upgrade under dash flasher to item # 90652 or 90649 LED

Item Number	LEDs	Lens	Package	Pack
FTL424803	40 Red	Red	Bulk	1 Pc.



1942-48 Ford Car

**Stainless Steel Flush Mount Tail light Bezel**

- Die stamped highly polished stainless steel

Item Number	Description	Package	Pack
F42805	Stainless Flush Mount Bezel	Bulk	1 Pc.



1942-48 Ford Car

**Chrome Flush Mount Tail light Bezel**

- Chrome flush mount bezel with 3 stud mount

Item Number	Description	Package	Pack
FTL4248R	Chrome Flush Mount Bezel	Bulk	1 Pc.

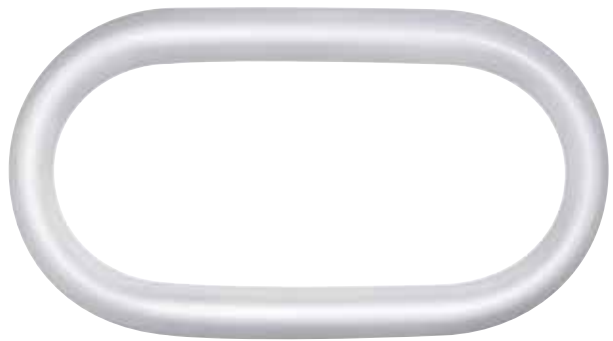

1942-48 Ford Car

**Stainless Steel Flush Mount Tail light Bezel**

- High quality durable rubber material

Item Number	Description	Package	Pack
FTL4248-1	Mounting Pad	Bulk	1 Pc.



*1947-48 Ford Car & 1942-47 Ford Truck*

**21 LED Parking Light Lens**

- 21 super bright LED tail light with polycarbonate lens
- Dual function with parking light and bright turn signal
- Easy wiring with 1157 double contact plug, 12 volt only
- Lens fits all original and reproduction Ford parking light assemblies
- Recommend to upgrade under dash flasher to item # 90652 or 90649 LED flasher
- Gasket available separately item # F474804

Item Number	LEDs	Lens	Package	Pack
<b>FTL4748A</b>	21 Amber	Amber	Carded	1 Pc./Carded
<b>FTL4748C</b>	21 Amber	Clear	Carded	1 Pc./Carded



*1949-50 Ford Car*

**33 LED Tail Light Assembly w/ Chrome Bezel**

- 33 super bright LED tail light lens with polycarbonate lens
- Epoxy coated, fully sealed electronics, 1157 plug
- Chrome zinc die cast rim, complete assembly includes housing, mounting hardware, socket, and wires
- Recommend to upgrade under dash flasher to item # 90652 or 90649 LED flasher

Item Number	LEDs	Lens	Package	Pack
<b>FTL4950LED-AS</b>	33 Red	Red	Carded	1 Pc./Carded



*1949-50 Ford Car*

**33 LED Tail Light**

- 33 super bright LED tail light lens with polycarbonate lens
- Epoxy coated, fully sealed electronics, 1157 plug
- Energy efficient solid-state circuit board for 12V DC systems
- Recommend to upgrade under dash flasher to item # 90652 or 90649 LED flasher

Item Number	LEDs	Lens	Package	Pack
<b>FTL4950LED</b>	33 Red	Red	Carded	1 Pc./Carded



*1949-50 Ford Passenger Car*

**Chrome Die Cast Tail light Bezel**

- Chrome die cast bezel for 1949-50 Ford passenger car tail light

Item Number	Description	Package	Pack
<b>F49503</b>	Chrome Tail light Bezel	Bulk	1 Pc.



*1949-50 Ford Passenger Car*

**Tail light Gasket**

- Made of high quality sponge rubber
- Die cut to the exact shape and size to provide a tight seal

Item Number	Description	Package	Pack
<b>F49501</b>	Tail light Gasket	Bulk	1 Pc.



*1949-50 Ford Passenger Car*

**Tail light Mounting Pad**

- Made of high quality sponge rubber
- Die cut to the exact shape and size to provide a tight seal

Item Number	Description	Package	Pack
<b>F49504</b>	Tail light Mounting Pad	Bulk	1 Pc.



**1940s-50s FORD**

1947-48 Ford Car & 1942-47 Ford Truck

**26 LED Parking Light Assembly**

- 26 super bright LED parking light with polycarbonate lens
- Dual function tail light and bright turn signal
- Complete assembly with LED lens and polished stainless steel rim
- Easy wiring with 1157 double contact plug, 12 volt only
- Includes stamped steel housing with socket, bulb, and pigtail
- Recommend to upgrade under dash flasher to item # 90652 or 90649 LED flasher. Fits L/H or R/H side

Item Number	LEDs	Lens	Package	Pack
110139	26 Amber	Amber	Carded	1 Pc./Carded
110138	26 Amber	Clear	Carded	1 Pc./Carded



1953-56 Ford Truck

**38 LED Sequential Tail Light W/ Chrome Housing**

- 38 SMD LED sequential tail light with polycarbonate lens
- Additional white LED with clear lens for license plate light
- Features sequential function with selector switch to control sequential function off, direction left, or direction right
- Features sequence-once brake attention function
- Fully assembled chrome plated die stamped metal housing
- Upgrade under dash flasher to item # 90652 or 90651

Item Number	LEDs	Lens	Application	Pack
110761	38 Red	Red	Driver	1 Pc./Carded
110762	38 Red	Red	Passenger	1 Pc./Carded

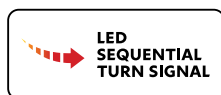

1951 Ford Passenger Car

**44 LED Tail Light Insert Board**

- Super bright LED circuit board installs behind existing lens
- Dual function with tail light & bright stop/turn signal
- Easy electrical connection with 1157 plug, no modification to vehicle
- Recommend to upgrade under dash flasher to item # 90652 or 90649 LED flasher

Item Number	LEDs	Lens	Package	Pack
110128	44 Red	Red	Carded	1 Pc./Carded



1953-56 Ford Truck

**38 LED Tail Light W/ Black Housing**

- 38 SMD LED sequential tail light with polycarbonate lens
- Additional white LED with clear lens for license plate light
- Fully assembled glossy black die stamped metal housing with studs
- Electronics completely sealed in epoxy to resist corrosion and moisture
- Solid-state circuit board engineered for 12V DC systems
- Recommend to upgrade under dash flasher to item # 90652 or 90651 LED flasher

Item Number	LEDs	Lens	Application	Pack
110759	38 Red	Red	Driver	1 Pc./Carded
110760	38 Red	Red	Passenger	1 Pc./Carded





*1953-56 Ford Truck*

**38 LED Sequential Tail Light w/ Black Housing**

- 38 super bright SMD LED sequential tail light with high quality polycarbonate lens
- Additional white LED with clear lens for license plate light
- Features sequential function with selector switch to control sequential function off, direction left, or direction right
- Features sequence-once brake attention function
- Fully assembled with beautiful glossy black plated die stamped metal housing with mounting studs
- Recommend to upgrade under dash flasher to item # 90652 (2-terminal) or 90651 (3-terminal)

Item Number	LEDs	Lens	Application	Pack
<b>110763</b>	38 Red	Red	Driver	1 Pc./Carded
<b>110764</b>	38 Red	Red	Passenger	1 Pc./Carded



*1953-56 Ford Truck*

**38 LED Sequential Tail Light**

- 38 super bright LED sequential tail light with high quality polycarbonate lens
- Additional white LED with clear lens for license plate light
- Features sequential function with selector switch to control sequential function off, direction left, or direction right
- Features sequence-once brake attention function
- 1157 double connector with offset pins, plugs into existing socket
- Recommend to upgrade under dash flasher to item # 90652 or 90651 LED flasher

Item Number	LEDs	Lens	Application	Pack
<b>110144</b>	38 Red	Red	Driver	1 Pc./Carded
<b>110145</b>	38 Red	Red	Passenger	1 Pc./Carded



*1953-56 Ford Truck*

**38 LED Tail Light Lens**

- 38 super bright LED tail light with high quality polycarbonate lens
- Additional white LED with clear lens for license plate light
- Easy electrical connection with 1157 plug, no modification to vehicle
- Electronics completely sealed in epoxy to resist corrosion and moisture
- Energy efficient solid-state circuit board for 12V DC systems
- Recommend to upgrade under dash flasher to item # 90652 (2-terminal) or 90651 (3-terminal)

Item Number	LEDs	Lens	Application	Pack
<b>110142</b>	38 Red	Red	Driver	1 Pc./Carded
<b>110143</b>	38 Red	Red	Passenger	1 Pc./Carded



**LED LIGHTS**  
**FORD MUSTANG**



1964 1/2-66 Ford Mustang

**68 LED Sequential Tail Light Lens**

- 68 super bright LEDs with polycarbonate lens
- Sequential operation with selector switch to select sequential left, sequential right, or sequential function off
- Epoxy coated, fully sealed electronics
- Easy wiring with 1157 double contact plug
- Energy efficient solid-state circuit board for 12VDC systems
- Recommend to upgrade under dash flasher to item # 90652 or 90649 LED
- Lifetime warranty

Item Number	LEDs	Lens	Package	Pack
110105	68 Red	Red	Carded	1 Pc./Card

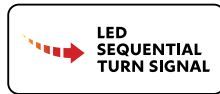

1964 1/2-66 Ford Mustang

**68 LED Tail Light Lens**

- 68 super bright LEDs with high quality polycarbonate lens
- Epoxy coated, fully sealed electronics, 1157 double contact plug
- Energy efficient solid-state circuit board for 12V DC systems
- Recommend to upgrade under dash flasher to item # 90652 or 90649 LED
- Chrome bezel sold separately item # F6405

Item Number	LEDs	Lens	Package	Pack
FTL6401LED	68 Red	Red	Carded	1 Pc./Card



1964 1/2-66 Ford Mustang

**68 LED Tail Light Lens With Chrome Housing & Rim**

- 68 super bright LEDs with high quality polycarbonate lens
- Includes original style wiring connector and mounting hardware
- Epoxy coated, fully sealed electronics
- Easy wiring with 1157 double contact plug
- Energy efficient solid-state circuit board for 12V DC systems
- Recommend to upgrade under dash flasher to item # 90652 or 90649 LED

Item Number	LEDs	Lens	Package	Pack
FTL6411LED	68 Red	Red	Carded	1 Pc./Card



1964 1/2-66 Ford Mustang

**48 LED Parking Light**

- 48 super bright amber LEDs with amber polycarbonate lens
- Not for use on early Mustang with single dash indicator
- Epoxy coated, fully sealed electronics
- Easy wiring with 1157 double contact plug
- Energy efficient solid-state circuit board for 12V DC systems

Item Number	LEDs	Lens	Package	Pack
FPL6401LED	48 Amber	Amber	Carded	1 Pc./Card



*1967-68 Ford Mustang*

**84 LED Sequential Tail Light Lens**

- 84 super bright LEDs with polycarbonate lens
- Sequential operation with selector switch to select sequential left, sequential right, or sequential function off
- Also features brake attention option with sequence-once function
- Epoxy coated fully sealed electronics, 1157 double plug
- Energy efficient solid-state circuit board for 12V DC systems
- Recommend to upgrade under dash flasher to item # 90652 or 90649 LED
- Lifetime warranty

Item Number	LEDs	Lens	Package	Pack
<b>110106</b>	84 Red	Red	Carded	1 Pc./Card

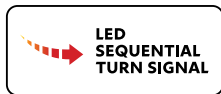

*1969 Ford Mustang*

**108 LED Sequential Tail Light Lens**

- 108 super bright LEDs with high quality polycarbonate lens
- Sequential operation with selector switch to select sequential left, sequential right, or sequential function off
- Includes polished stainless steel trim rings attached
- Epoxy coated fully sealed electronics, 1157 double contact plug
- Energy efficient solid-state circuit board for 12VDC systems
- Recommend to upgrade under dash flasher to item # 90652 or 90649 LED
- Lifetime warranty

Item Number	LEDs	Lens	Package	Pack
<b>110107</b>	108 Red	Red	Carded	1 Pc./Card

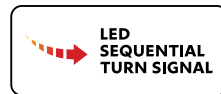

*1967-68 Ford Mustang*

**84 LED Tail Light Lens**

- 84 super bright LEDs with high quality polycarbonate lens
- Epoxy coated fully sealed electronics, 1157 double contact plug
- Energy efficient solid-state circuit board for 12V DC systems
- Recommend to upgrade under dash flasher to item # 90652 or 90649

Item Number	LEDs	Lens	Package	Pack
<b>FTL6701LED</b>	84 Red	Red	Carded	1 Pc./Card



*1969 Ford Mustang*

**108 LED Tail Light**

- 108 super bright LEDs with high quality polycarbonate lens
- Includes polished stainless steel rims
- Epoxy coated fully sealed electronics, 1157 double contact plug
- Energy efficient solid-state circuit board for 12V DC systems
- Includes polished stainless steel trim ring attached
- Recommend to upgrade under dash flasher to item # 90652 or 90649

Item Number	LEDs	Lens	Package	Pack
<b>FTL6901LED</b>	108 Red	Red	Carded	1 Pc./Card

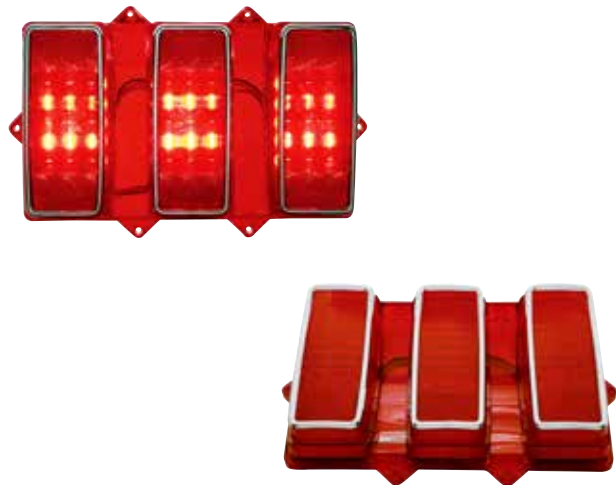



*1961 Ford Thunderbird*

**41 LED Tail Light**

- 41 super bright red LEDs with high quality polycarbonate lens
- Epoxy coated, fully sealed electronics, 1157 plug
- Energy efficient solid-state circuit board for 12V DC systems
- Recommend to upgrade under dash flasher to item # 90652 or 90649 LED flasher
- Rubber mounting pad sold separately, item # S10051-1

Item Number	LEDs	Lens	Package	Pack
<b>FTL6106LED</b>	41 Red	Red	Carded	1 Pc./Card

*1964 Ford Thunderbird*

**68 LED Tail Light**

- 68 super bright red LEDs with high quality polycarbonate lens
- Epoxy coated, fully sealed electronics, 1157 plug
- Easy wiring with 1157 double contact plug
- Energy efficient solid-state circuit board for 12V DC systems
- Recommend to upgrade under dash flasher to item # 90652 or 90649 LED flasher

Item Number	LEDs	Lens	Package	Pack
<b>FTL6406LED</b>	68 Red	Red	Carded	1 Pc./Card



*1964 Ford Thunderbird*

**Tail Light Lens with Chrome Emblem**

- High quality reproduction of the original lens
- Beautiful chrome plate emblem

Item Number	Description	Package	Pack
<b>F6411</b>	Tail light Lens with Emblem	Bulk	1 Pc.



*1964 Ford Thunderbird*

**Tail Light Lens**

- High quality reproduction of the original lens

Item Number	Description	Package	Pack
<b>F6411-1</b>	Tail light Lens	Bulk	1 Pc.



*1964 Ford Thunderbird*

**Chrome Thunderbird Tail Light Emblem**

- Beautiful chrome plated finish with triple chrome plating process
- Perfect replacement for missing or damaged tail light emblem

Item Number	Description	Package	Pack
<b>F6412</b>	Tail light Emblem	Bulk	1 Pc.



**LED LIGHTS**  
**FORD BRONCO**



1967-72 Ford Truck & 1966-77 Ford Bronco

**27 LED Tail Light Insert Board**

- Retrofit circuit board with super bright LEDs
- Installs behind original tail light lens
- Dual function with driving, and bright stop/turn signal
- Easy electrical connection w/ 1157 plug no modification to vehicle
- Recommend to upgrade under dash flasher to item # 90652 or 90649 LED

Item Number	LEDs	Application	Package	Pack
<b>FTL6772LED-PR</b>	27 Red	Driver/passenger	Carded	1 Pair
<b>FTL6772LED-L</b>	27 Red	Driver	Bulk	1 Pc.
<b>FTL6772LED-R</b>	27 Red	Passenger	Bulk	1 Pc.

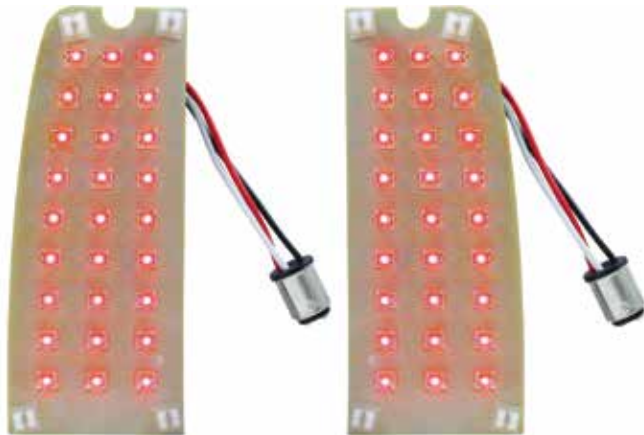

**2** SOLD IN PAIRS



1966-77 Ford Bronco

**Anodized Billet Aluminum Tail Light Bezel (Pair)**

- CNC milled out of a single solid aluminum block
- Beautifully CNC milled from billet aluminum
- Durable anodized finish to resist corrosion while keeping the machined finished look
- Stainless steel extended length socket head screws included for use with original tail light lens mounting holes
- Includes foam gaskets to prevent scratches to the tail light panel

Item Number	Description	Package	Pack
<b>110583</b>	Clear Anodized Aluminum	Box	1 Pair
<b>110584</b>	Black Anodized Aluminum	Box	1 Pair



**2** SOLD IN PAIRS



1967-72 Ford Truck & 1966-77 Bronco

**Tail Light Lens Gaskets (Pair)**

- Fits between tail light housing and lens
- Made of quality white foam rubber as original
- Die cut to the exact shape and size as original to provide a nice tight seal

Item Number	Description	Package	Pack
<b>F677203</b>	Tail Light Lens Gasket	Card	1 Pair

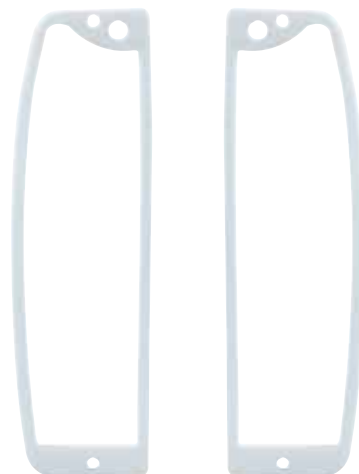

**2** SOLD IN PAIRS

**LED LIGHTS**  
**FORD BRONCO**

1969-77 Ford Bronco

**Anodized Billet Aluminum Turn Signal Bezel (Pair)**

- Beautifully CNC milled from billet aluminum
- Durable clear anodized finish to resist corrosion while keeping the machined finished look
- Mounts between the front turn signal bucket and the grille
- Includes mounting gaskets, sold in pairs

Item Number	Description	Package	Pack
<b>110837</b>	Clear Anodized Aluminum	Box	1 Pair
<b>110838</b>	Black Anodized Aluminum	Box	1 Pair



1969-77 Ford Bronco

**35 LED Front Parking/Signal Light**

- 35 LED parking/signal light for 1969-77 Ford Bronco
- LED dual function, parking light and turn signal
- Epoxy coated, fully sealed electronics, 1157 plug
- Fits left hand or right hand
- Also fits 1959-64 Ford F100, F250, F350, and 1968-74 Econoline

Item Number	LEDs	Lens	Package	Pack
<b>110382</b>	35 Amber	Amber	Carded	1 Pc./Card



1970-77 Ford Bronco

**Anodized Billet Aluminum Low Side Marker Bezel**

- Anodized billet aluminum side marker bezel with raised side protection
- Beautifully CNC milled from billet aluminum
- Durable clear anodized finish to resist corrosion while keeping the machined finished look
- Includes two stainless steel screws and mounting gasket
- Also fits 1970-74 Econoline, and rear 1970-72 F100, F150, & F250
- Sold each

Item Number	Description	Package	Pack
<b>110774</b>	Clear Anodized Aluminum	Box	1 Pc.
<b>110775</b>	Black Anodized Aluminum	Box	1 Pc.





*1969-77 Ford Bronco*

**Anodized Billet Aluminum Side Marker Bezel**

- Anodized billet aluminum side marker bezel with raised side protection
- Beautifully CNC milled from billet aluminum
- Durable clear anodized finish to resist corrosion while keeping the machined finished look
- Includes two stainless steel screws and mounting gasket
- Also fits 1970-74 Econoline, and rear 1970-72 F100, F150, & F250
- Sold each

Item Number	Description	Package	Pack
<b>110772</b>	Clear Anodized Aluminum	Box	1 Pc.
<b>110773</b>	Black Anodized Aluminum	Box	1 Pc.



*1970-77 Ford Bronco*

**8 LED Side Marker Light**

- 8 LED dual function, parking light and turn signal
- Super bright amber LED with amber acrylic lens
- Epoxy coated, fully sealed electronics
- Fits left hand and right hand

Item Number	LEDs	LENS	Application	Package	Pack
<b>110804</b>	8 Amber	Amber	Front	Carded	1 Pc./Card
<b>110805</b>	8 Red	Red	Rear	Carded	1 Pc./Card



*1953-56 Ford Truck*

**12 LED License Plate Light W/ Clear Lens**

- 12 super bright white LEDs with high quality polycarbonate lens
- Epoxy coated, fully sealed electronics
- Easy electrical connection w/ 1157 plug, no modification to vehicle
- Energy efficient solid-state circuit board for 12V DC systems

Item Number	LEDs	Lens	Package	Pack
<b>FTL5356LLB</b>	12 White	Clear	Carded	1 Pc./Card



**LED LIGHTS**  
**1950s PONTIAC**

1963-67 Shelby Cobra

**36 LED Tail Light**

- Exact replacement of original Shelby Cobra tail light
- Includes mounting pad and hardware
- Energy efficient solid-state circuit board for 12V DC systems
- Epoxy coated, fully sealed electronics
- Recommend to upgrade under dash flasher to item # 90652 or 90649 LED flasher

Item Number	LEDs	Lens	Application	Pack
STL1012LED	36 Red	Red	Tail light	1 Pc./Card



1950s Pontiac Style

**41 LED Round Tail Light**

- 41 super bright amber LEDs with amber polycarbonate lens
- 3 5/16" diameter tail light
- Epoxy coated, fully sealed electronics
- Fits United Pacific rim item # S1005
- Recommend to upgrade under dash flasher to item # 90652 or 90649 LED

Item Number	LEDs	Lens	Package	Pack
STL1001LED	41 Red	Red	Carded	1 Pc./Card



1950s Ford Pontiac

**Chrome 1950s Pontiac Style Tail Light Bezel**

- 4 5/16 round chrome zinc die-cast bezel with two mounting studs
- Fits Pontiac style LED light item # STL1001LED/STL1002

Item Number	Description	Package	Pack
S1005	Pontiac Style Tail Light Bezel	Bulk	1 Pc.

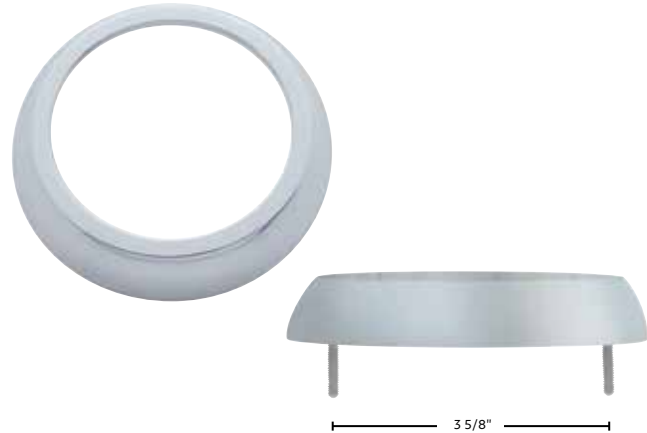

1950s Pontiac Style

**41 LED Pontiac Style Tail Light W/ Chrome Bezel**

- 41 super bright red LEDs with high quality polycarbonate lens
- 3 5/16" dia. with 4 5/16" dia. chrome bezel
- Epoxy coated, fully sealed electronics
- Energy efficient solid-state circuit board for 12V DC systems
- Rubber pad sold separately item # S10051-1
- Recommend to upgrade under dash flasher to item # 90652 or 90649 LED flasher

Item Number	LEDs	Lens	Package	Pack
STL1006LED	41 Red	Red	Carded	1 Pc./Card



1950s Pontiac Style

**41 LED Spider Web Style Tail Light**

- 41 super bright LEDs with high quality polycarbonate lens
- Chrome spider lens overlay styled after 1936 Chrysler Airflow tail lamp lens, mounts flat to surface with 2 small studs
- Dual function with tail light & bright turn signal
- Epoxy coated, fully sealed electronics
- Rubber mounting pad sold separately, item # S1005-1

Item Number	LEDs	Lens	Application	Pack
STL1004LED	41 Red	Red	LH & RH	1 Pc./Box



1937-42 Willys

**22 LED Tail Light Assembly**

- 22 super bright red LEDs with polished stainless steel bezel
- Mounts with two studs, long enough to use with fiberglass bodies
- Includes flat mounting pad and wedge mounting pad
- Epoxy coated, fully sealed electronics
- Energy efficient solid-state circuit board for 12VDC systems
- Recommend to upgrade under dash flasher to item # 90652 or 90649 LED

Item Number	LEDs	Lens	Package	Pack
<b>STL1010LED-AS</b>	22 Red	Red	Bulk	1 Pc.



1937-42 Willys

**22 LED Tail Light**

- Fits in place of the original glass lens
- Epoxy coated, fully sealed electronics
- Energy efficient solid-state circuit board for 12VDC systems
- Recommend to upgrade under dash flasher to item # 90652 or 90649 LED

Item Number	LEDs	Lens	Package	Pack
<b>STL1010LED</b>	22 Red	Red	Carded	1 Pc./Card



1968 Dodge Charger

**25 LED Tail Light**

- 25 super bright LEDs with polycarbonate lens
- Epoxy coated, fully sealed electronics
- Easy wiring with 1157 double contact plug
- Solid state circuit boards are designed for 7.7 - 14.0 VDC

Item Number	LEDs	Lens	Package	Pack
<b>DTL6801LED</b>	25 Red	Red	Carded	1 Pc./Card

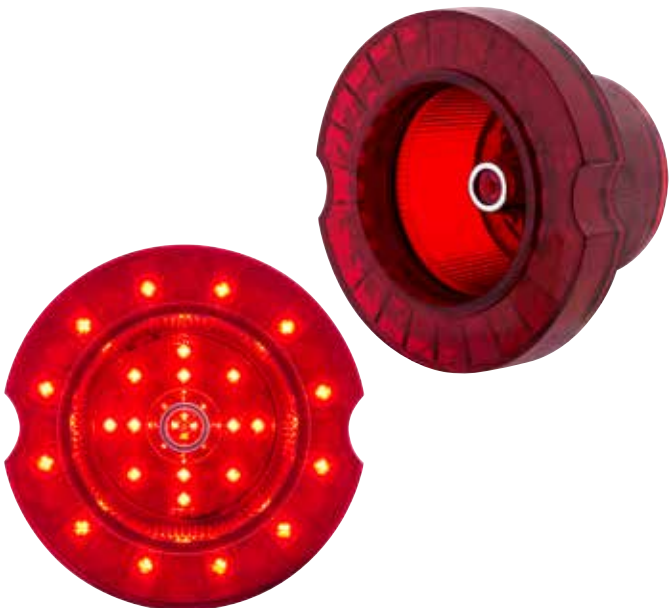

1968-70 VW Beetle

**46 LED Tail Light**

- 46 super bright red LEDs for tail light/stop light/turn signal
- 20 super bright white LEDs for backup light, polycarbonate lens
- Plug-n-play, fits in place of original lens without modification
- Easy electrical hook-up with mail push-on terminals
- Includes stainless steel trim and mounting screws

Item Number	LEDs	Lens	Application	Pack
<b>VTL6870LED</b>	46 Red 20 White	Red/ White	Tail Back-Up	1 Pc./Card



# HONDA & PEDESTAL LIGHTS

*Honda*

**13 LED 2 1/8" Arm Light Kit w/ Flame Bezel**

- 13 super bright LED Honda light with 2 1/8" arm and flame bezel
- Beautiful high quality chrome plated housing with triple chrome plating process
- 2 wires (hard wired)

Item Number	LEDs	Lens	Package	Pack
<b>38496</b>	13 Amber	Amber	Carded	1 Pc./Card
<b>38497</b>	13 Red	Red	Carded	1 Pc./Card
<b>38498</b>	13 White	Clear	Carded	1 Pc./Card



*Honda*

**13 LED 1 1/8" Arm Light Kit w/ Flame Bezel**

- 13 super bright LED Honda light with 1 1/8" arm and flame bezel
- Beautiful high quality chrome plated housing with triple chrome plating process
- 2 wires (hard wired)

Item Number	LEDs	Lens	Package	Pack
<b>38492</b>	13 Amber	Amber	Carded	1 Pc./Card
<b>38493</b>	13 Red	Red	Carded	1 Pc./Card
<b>38494</b>	13 Amber	Clear	Carded	1 Pc./Card



*Honda*

**13 LED 1 1/8" Arm Watermelon Light Kit**

- 13 super bright LED watermelon Honda light with 1 1/8" arm
- Beautiful high quality chrome plated housing with triple chrome plating process
- 2 wires (hard wired)

Item Number	LEDs	Lens	Package	Pack
<b>38820</b>	13 Amber	Amber	Carded	1 Pc./Card



**LED LIGHTS**  
**HONDA & PEDESTAL LIGHTS**

*Honda*

**11 LED 2 1/8" Arm Watermelon Light Kit w/ Visor**

- 11 super bright LED watermelon Honda light with 2 1/8" arm and visor
- Beautiful high quality chrome plated housing with triple chrome plating process
- 2 wires (hard wired)

Item Number	LEDs	Lens	Package	Pack
<b>38595</b>	11 Amber	Amber	Carded	1 Pc./Card
<b>38597</b>	11 Amber	Clear	Carded	1 Pc./Card



*Honda*

**11 LED 1 1/8" Arm Watermelon Light Kit w/ Visor**

- 11 super bright LED watermelon Honda light with 1 1/8" arm and visor
- Beautiful high quality chrome plated housing with triple chrome plating process
- 2 wires (hard wired)

Item Number	LEDs	Lens	Package	Pack
<b>38444</b>	11 Amber	Amber	Carded	1 Pc./Card
<b>38446</b>	11 Amber	Clear	Carded	1 Pc./Card
<b>38445</b>	11 Red	Red	Carded	1 Pc./Card
<b>38447</b>	11 Red	Clear	Carded	1 Pc./Card



*Honda*

**13 LED 2 1/8" Arm Watermelon Light Kit**

- 13 super bright LED watermelon Honda light with 2 1/8" arm
- Beautiful high quality chrome plated housing with triple chrome plating process
- 2 wires (hard wired)

Item Number	LEDs	Lens	Package	Pack
<b>38824</b>	13 Amber	Amber	Carded	1 Pc./Card

# HONDA & PEDESTAL LIGHTS

*Honda*

**11 LED 2 1/8" Arm Watermelon Light Kit**

- 11 super bright LED watermelon Honda light with 2 1/8" arm
- Beautiful high quality chrome plated housing with triple chrome plating process
- 2 wires (hard wired)

Item Number	LEDs	Lens	Package	Pack
38440	11 Amber	Amber	Carded	1 Pc./Card
38442	11 Amber	Clear	Carded	1 Pc./Card
38441	11 Red	Red	Carded	1 Pc./Card
38443	11 Red	Clear	Carded	1 Pc./Card



*Honda*

**11 LED 1 1/8" Arm Watermelon Light Kit**

- 11 super bright LED watermelon Honda light with 1 1/8" arm
- Beautiful high quality chrome plated housing with triple chrome plating process
- 2 wires (hard wired)

Item Number	LEDs	Lens	Package	Pack
38436	11 Amber	Amber	Carded	1 Pc./Card
38438	11 Amber	Clear	Carded	1 Pc./Card
38437	11 Red	Red	Carded	1 Pc./Card
38439	11 Red	Clear	Carded	1 Pc./Card



*Honda*

**13 LED 2 1/8" Arm Light Kit**

- 13 super bright LED Honda light with 2 1/8" arm
- High quality chrome plated housing with triple chrome plating
- 2 wires (hard wired)

Item Number	LEDs	Lens	Package	Pack
<b>38379</b>	13 Amber	Amber	Carded	1 Pc./Card
<b>38389</b>	13 Amber	Clear	Carded	1 Pc./Card
<b>38380</b>	13 Red	Red	Carded	1 Pc./Card



*Honda*

**13 LED 1 1/8" Arm Light Kit**

- 13 super bright LED Honda light with 1 1/8" arm
- High quality chrome plated housing with triple chrome plating
- 2 wires (hard wired)

Item Number	LEDs	Lens	Package	Pack
<b>38375</b>	13 Amber	Amber	Carded	1 Pc./Card
<b>38377</b>	13 Amber	Clear	Carded	1 Pc./Card
<b>38376</b>	13 Red	Red	Carded	1 Pc./Card



*Pedestal Light*

**2 High Power LED "Hyper Mini"**

- 1W rebel 3045 LED, 100. Waterproof compact design
- Heavy duty chrome die-cast housing
- Vertical & horizontal mounting application
- Universal application, install anywhere
- Lifetime warranty

Item Number	LEDs	Lens	Package	Pack
<b>36675</b>	2 Red	Clear	Carded	1 Pc./Card



# ROD AND BULLET LIGHTS

## 6 LED Medium Rod Lights

- 6 LED medium rectangular rod light with chrome housing
- 3 wires (hard wired), 12 volt

Item Number	LEDs	Lens	Package	Pack
39192	6 Amber	Amber	Carded	1 Pc./Card
39193	6 Red	Red	Carded	1 Pc./Card



## 4 LED Small Rod Lights

- 4 LED small rectangular rod light with chrome housing
- 3 wires (hard wired), 12 volt

Item Number	LEDs	Lens	Package	Pack
39188	4 Amber	Amber	Carded	1 Pc./Card
39189	4 Red	Red	Carded	1 Pc./Card



## 6 LED Large Rod Lights

- 6 LED large rectangular rod light with chrome housing
- 3 wires (hard wired), 12 volt

Item Number	LEDs	Lens	Package	Pack
39196	6 Amber	Amber	Carded	1 Pc./Card
39197	6 Red	Red	Carded	1 Pc./Card



## 9 LED Dual Function Mini Bullet Lights

- 9 LED mini bullet light with chrome housing, dual function
- Perfect for custom installation on motorcycles, trucks and hot rods
- Chrome bullet housing available separately: item # 30105B

Item Number	LEDs	Lens	Package	Pack
36859	9 Amber	Amber	Carded	1 Pc./Card
36860	9 Red	Red	Carded	1 Pc./Card



## 4 LED Small Rod Light

- 4 super bright LEDs with polycarbonate lens
- 3 wires (hard wired)

Item Number	LEDs	Lens	Package	Pack
39512B	4 Red	Red	Bulk	1 Pc./Bulk





**15 LED 3" Single Face Light**

- 15 LED single face auxiliary light with chrome housing
- For auxiliary/utility light applications, 2 wires (hard wired)

Item Number	LEDs	Lens	Package	Pack
<b>38853</b>	15 Amber	Amber	Carded	1 Pc./Card
<b>38855</b>	15 Amber	Clear	Carded	1 Pc./Card
<b>38856</b>	15 Red	Clear	Carded	1 Pc./Card



**17 LED Watermelon Double Face Light**

- Durable heavy duty chrome plated housing with single stud mount
- Beautiful high quality chrome plated housing with triple chrome plating process
- For auxiliary/utility light application, 2 wires (hard wired)
- Universal application, install anywhere, lifetime warranty

Item Number	LEDs	Lens	Package	Pack
<b>32326</b>	17 Amber/Red	Amber/Red	Carded	1 Pc./Card
<b>32329</b>	17 Amber/Red	Clear	Carded	1 Pc./Card
<b>37308</b>	17 Amber	Dark Amber	Carded	1 Pc./Card



**3 LED Straight Mount Double Face Light**

- 3 LED rectangular double face auxiliary light
- Chrome die-cast t-mount housing only item # 30963b
- 2 wires (hard wired)

Item Number	LEDs	Lens	Package	Pack
<b>38842</b>	3 Amber/Red	3 Amber/Red	Carded	1 Pc./Card
<b>38843</b>	3 Amber/Red	Clear	Carded	1 Pc./Card



**3 LED T-Mount Double Face Light**

- 3 LED rectangular double face auxiliary light
- Chrome die-cast t-mount housing only item # 30962b
- 2 wires (hard wired)

Item Number	LEDs	Lens	Package	Pack
<b>38840</b>	3 Amber/Red	3 Amber/Red	Carded	1 Pc./Card
<b>38841</b>	3 Amber/Red	Clear	Carded	1 Pc./Card



**19 LED 17" Stop, Turn, Tail Light Bar With Bezel**

- 19 LED S/T/T light bar with chrome plastic bezel
- Perfect for trailers or below tailgate on pickups
- Approximate size 17 1/8" L x 1 5/8" W x 1 1/8" H
- Mounting holes are approximately 16" apart

Item Number	LEDs	Lens	Package	Pack
36833	19 Red	Red	Carded	1 Pc./Card



**17 LED Flush Mount Tail Light W/ Chrome Bezel**

- 17 super bright red LED flush mount bezel
- Light is 3-3/4" dia. and 3/4" tall
- Mounting studs are approximately 3-7/16" apart
- Includes installation hardware and mounting pad
- Recommend to upgrade under dash flasher to item # 90652 or 90649 LED flasher

Item Number	LEDs	Lens	Application	Pack
110406	17 Red	Red	Tail light	1 Pc./Card



**10 LED Split Function 3rd Brake Light**

- 10 bright red LED 3rd brake light with swivel pedestal base, red polycarbonate lens and beautiful chrome plated housing and base
- Adjustable base mount for inside rear window installation
- Mounting base swivels 180 degrees for multiple applications

Item Number	LEDs	Lens	Application	Pack
33010	10 Red	Red	Brake Light	1 Pc./Card



**40 LED Stop, Turn & Tail light With Bezel**

- 40 Super bright red LED S/T/T light with chrome plastic bezel
- Flush mount
- Chrome plastic bezel available separately: item # 34027B

Item Number	LEDs	Lens	Application	Pack
37961	40 Red	Red	S/T/T Light	1 Pc./Card



**15 LED Pick-Up/SUV Cab Light**

- Beautiful chrome plated housing
- Polycarbonate lens sonically sealed to housing to prevent moisture intrusion, epoxy coated fully sealed electronics
- 2 wires (1 wire with ring terminal)

Item Number	LEDs	Lens	Package	Pack
<b>38453</b>	15 Amber	Amber	Carded	1 Pc./Card
<b>38454</b>	15 Amber	Clear	Carded	1 Pc./Card



**13 LED Pick-Up/SUV Cab Light**

- Beautiful chrome plated housing
- Polycarbonate lens sonically sealed to housing to prevent moisture intrusion, epoxy coated fully sealed electronics
- 2 wires (1 wire with ring terminal)

Item Number	LEDs	Lens	Package	Pack
<b>38451</b>	15 Amber	Amber	Carded	1 Pc./Card
<b>38450</b>	15 Amber	Clear	Carded	1 Pc./Card



**6 Amber LED Pick-Up/SUV Cab Light**

- Polycarbonate lens sonically sealed to housing to prevent moisture intrusion, epoxy coated fully sealed electronics
- Fits various standard pickup trucks
- Includes mounting gasket

Item Number	LEDs	Lens	Package	Pack
<b>36621B</b>	6 Amber	Amber	Carded	1 Pc./Card



**12 LED Door/Interior Light**

- 12 super bright amber LED door/interior light with amber lens
- Includes chrome plastic bezel

Item Number	LEDs	Lens	Package	Pack
<b>38021</b>	12 Amber	Amber	Carded	1 Pc./Card



**LED ACCESSORY LIGHTS**  
**MISCELLANEOUS**

**4 LED DUAL FUNCTION MINI WATERMELON LIGHT (CLEARANCE/MARKER)**

- Features 4 super bright dual function LEDs with beautiful polished stainless steel bezel
- Quality polycarbonate lens with watermelon style lens design, epoxy sealed to prevent moisture intrusion
- Requires 3/4" diameter hole for installation
- Mounts with included rubber grommet
- 12V DC, 3 wire hookup
- Wiring color code: white=ground, black=low function, red=high function

Item Number	LEDs	Lens	Package	Pack
34847	4 Amber	Amber	Carded	1 Pc./Card
34848	4 Red	Red	Carded	1 Pc./Card
34849	4 Amber	Clear	Carded	1 Pc./Card
34850	4 Red	Clear	Carded	1 Pc./Card
34851	4 Blue	Clear	Carded	1 Pc./Card
34852	4 White	Clear	Carded	1 Pc./Card

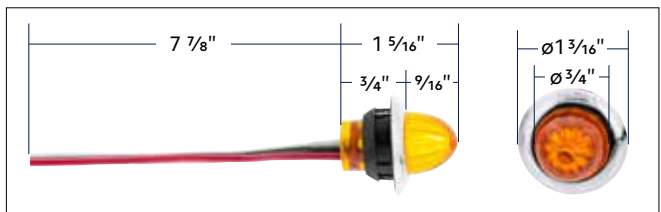

**DUAL FUNCTION**

**STAINLESS STEEL BEZEL**

**4 LED DUAL FUNCTION MINI SPIKE LIGHT W/ SS BEZEL (CLEARANCE/MARKER)**

- Spike lens shape with unique frosted inner design
- Features 4 super bright 12V LEDs
- Polished stainless steel bezel
- Fully epoxy sealed to prevent moisture intrusion
- Mounts with included rubber grommet
- Easy wiring with 3 male bullet plugs
- Requires a 3/4" opening
- Available in various LED color and lens color options

Item Number	LEDs	Lens	Package	Pack
34841	4 Amber	Amber	Carded	1 Pc./Card
34842	4 Red	Red	Carded	1 Pc./Card
34843	4 Amber	Clear	Carded	1 Pc./Card
34844	4 Red	Clear	Carded	1 Pc./Card
34845	4 Blue	Clear	Carded	1 Pc./Card
34846	4 White	Clear	Carded	1 Pc./Card

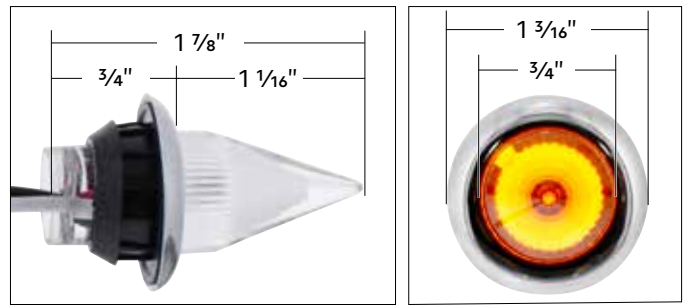

**4 LEDs**

**DUAL FUNCTION**

**STAINLESS STEEL BEZEL**

# ARCBLAST

## LED DUAL FUNCTION ARCBLAST MINI LIGHT (CLEARANCE/MARKER)

- Single super bright LED with stainless steel bezel
- Dual functions with high and low brightness
- Polycarbonate lens epoxy sealed to housing to prevent moisture intrusion
- Requires 3/4" diameter hole for installation
- Mounts with included rubber grommet
- 12V DC, straight forward 3 wire hookup

Item Number	LEDs	Lens	Package	Pack
34820	1 Amber	Amber	Carded	1 Pc./Card
34821	1 Red	Red	Carded	1 Pc./Card
34822	1 Amber	Clear	Carded	1 Pc./Card
34823	1 Red	Clear	Carded	1 Pc./Card
34824	1 Amber	Amber	Carded	1 Pc./Card
34825	1 Red	Red	Carded	1 Pc./Card
34826	1 Amber	Clear	Carded	1 Pc./Card
34827	1 Red	Clear	Carded	1 Pc./Card

## LED ACCESSORY LIGHTS MISCELLANEOUS



## 4 LED Mini Bullet Marker Lights

- 4 LED die-cast mini bullet marker light
- Universal application, mounts anywhere, perfect for trucks, 12 volt

Item Number	LEDs	Lens	Package	Pack
37151	4 Blue	Clear	Carded	1 Pc./Card
37153	4 Red	Clear	Carded	1 Pc./Card
37154	4 White	Clear	Carded	1 Pc./Card



**1 SMD LED Mini Clearance/Marker Lights**

- 1 SMD LED mini clearance/marker light with rubber grommet.
- Polycarbonate lens sonically sealed to housing to prevent moisture
- Requires a 3/4" diameter hole for installation
- Lifetime warranty

Item Number	LEDs	Lens	Package	Pack
36843	1 Amber	Amber	Carded	1 Pc./Card
36844	1 Red	Red	Carded	1 Pc./Card

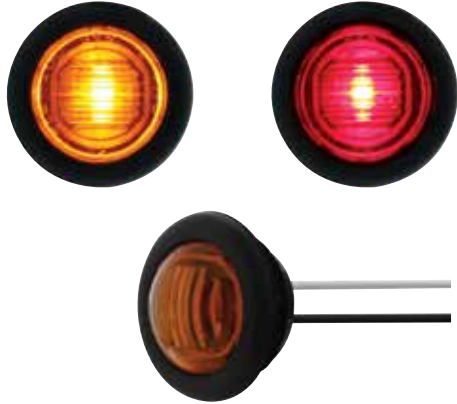

**3 LED Dual Function Mini Auxiliary/Utility/Light W/ Bezel**

- 3 LED mini dual function clearance marker light with stainless steel bezel
- Requires a 3/4" diameter hole for installation
- Fits panels and bumpers up to 1/4" thick
- Includes plastic backing washer for mounting on thin body panels

Item Number	LEDs	Lens	Package	Pack
36600	3 Amber	Amber	Carded	1 Pc./Card
36601	3 Red	Red	Carded	1 Pc./Card
36602	3 Amber	Clear	Carded	1 Pc./Card
36603	3 Red	Clear	Carded	1 Pc./Card

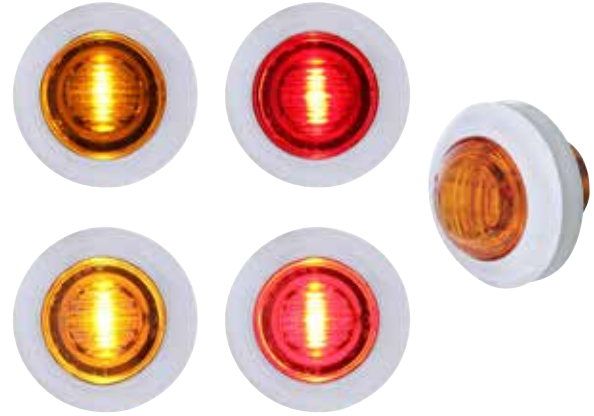

**3 LED Mini Clearance/Marker Lights**

- Requires a 13/16" opening, grommet mount, 7 1/2" wire lead
- Stainless bezel available separately: item # 20527B

Item Number	LEDs	Lens	Package	Pack
39767	3 Amber	Amber	Carded	1 Pc./Card
39768	3 Red	Red	Carded	1 Pc./Card
39769	3 Amber	Clear	Carded	1 Pc./Card
39770	3 Red	Clear	Carded	1 Pc./Card
39771	3 Blue	Clear	Carded	1 Pc./Card
39772	3 White	Clear	Carded	1 Pc./Card



**3 LED Mini Clearance/Marker Lights - Stainless Steel**

- Requires a 13/16" opening, grommet mount, 7 1/2" wire lead
- Stainless bezel available separately: item # 20527B

Item Number	LEDs	Lens	Light	Pack
39932	3 Amber	Amber	39767	1 Pc./Card
39933	3 Red	Red	39768	1 Pc./Card
39934	3 Amber	Clear	39769	1 Pc./Card
39935	3 Red	Clear	39770	1 Pc./Card
39936	3 Blue	Clear	39771	1 Pc./Card
39937	3 White	Clear	39772	1 Pc./Card



**LED Bullet Fastener Lights**

- 4 LED die-cast mini bullet marker light
- Universal application, mounts anywhere, perfect for trucks, 12 volt

Item Number	LEDs	Lens	Package	Pack
10863	1 Amber	Amber	Carded	2 Pcs./Card
10864	1 Blue	Blue	Carded	2 Pcs./Card
10867	1 Red	Red	Carded	2 Pcs./Card
10862	1 White	Clear	Carded	2 Pcs./Card



**1 LED Indicator Lights**

- Indicator light with 1 super bright LED
- Requires 1/4" diameter hole for installation, 12 volt

Item Number	LEDs	Lens	Package	Pack
39314	1 Amber	Amber	Carded	1 Pc./Card
39314B	1 Amber	Amber	Bulk	1 Pc.
39315	1 Blue	Blue	Carded	1 Pc./Card
39315B	1 Blue	Blue	Bulk	1 Pc.
39316	1 Green	Green	Carded	1 Pc./Card
39316B	1 Green	Green	Bulk	1 Pc.
39317	1 Purple	Purple	Carded	1 Pc./Card
39317B	1 Purple	Purple	Bulk	1 Pc.
39318	1 Red	Red	Carded	1 Pc./Card
39318B	1 Red	Red	Bulk	1 Pc.
39319	1 White	Clear	Carded	1 Pc./Card
39319B	1 White	Clear	Bulk	1 Pc./Card



**1 LED License Plate Fastener Lights (2 Pack)**

- Super bright LED fastener with stainless steel housing
- Perfect for license plates, interior and under the hood lighting
- Includes nylon mounting nuts. Requires 5/16" diameter hole for installation
- 12 Volt DC. Easy hookup with 8 1/2" wire leads

Item Number	LEDs	Lens	Package	Pack
70301	1 Blue	Clear	Carded	2 Pcs./Card
70302	1 Red	Clear	Carded	2 Pcs./Card
70303	1 White	Clear	Carded	2 Pcs./Card



**Mini Pilot Lights**

- Simple wiring connection with 0.180" diameter ring terminal at wire end
- Requires 3/8" diameter mounting holes, universal application

Item Number	LEDs	Lens	Package	Pack
40051	1 Amber	Amber	Carded	2 Pcs./Card
40052	1 Blue	Blue	Bulk	2 Pcs./Card
40053	1 Green	Green	Carded	2 Pcs./Card
40055	1 Red	Red	Bulk	2 Pcs./Card



**MISCELLANEOUS**

**21 High Power LED 6 1/4" Dome Light W/ Bezel**

- 21 high power LED dome light with chrome plated bezel
- 6 1/4" round
- 12V/24V application

Item Number	LEDs	Lens	Package	Pack
37625B	21 White	Clear	Carded	1 Pc./Card



**4 LED Dome Light With Chrome Bezel**

- 4 super bright LED clear lens auxiliary light w/ chrome plastic bezel
- 2 wires (hard wired)
- Mounting holes are 2 3/16" apart

Item Number	LEDs	Lens	Package	Pack
38931	4 Amber	Clear	Carded	1 Pc./Card
38936	4 White	Clear	Carded	1 Pc./Card



**3 LED 1" Dual Function Auxiliary/Utility Light W/ Visor**

- 3 high power amber LED 1" auxiliary/utility light with visor

Item Number	LEDs	Lens	Package	Pack
36899	3 Amber	Amber	Carded	1 Pc./Card



**5 LED Tab Mounting Auxiliary/Utility Light**

- Super bright LEDs with high quality injection molded polycarbonate lens
- Easy hookup to any 12V DC system
- Clip attachment

Item Number	LEDs	Lens	Package	Pack
CTL4950LED	5 Red	Red	Carded	1 Pc./Card

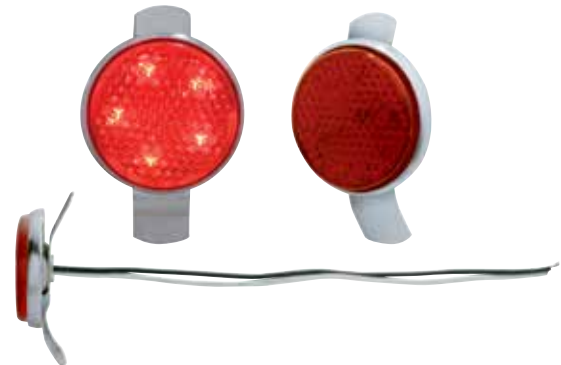

**30 LED 19 1/2" Auxiliary/Utility Flex Strip Light**

- Can be used as accent lighting under dash edges, arm rest, inside trunk and engine compartment
- Easily attaches with adhesive tape
- Not designed or warranted for exterior use

Item Number	LEDs	Package	Pack
37954	30 Amber	Carded	1 Pc./Card
37957	30 Red	Carded	1 Pc./Card

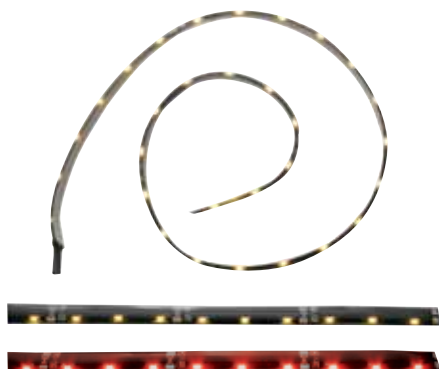

**45 LED 35 1/4" Auxiliary/Utility Flex Strip Light**

- 45 super bright LED flex strip light

Item Number	LEDs	Wire Exit	Package	Pack
37623	45 Red	Left	Carded	1 Pc./Card
37624	45 Red	Right	Carded	1 Pc./Card
37659	45 White	Left	Carded	1 Pc./Card
37660	45 White	Right	Carded	1 Pc./Card

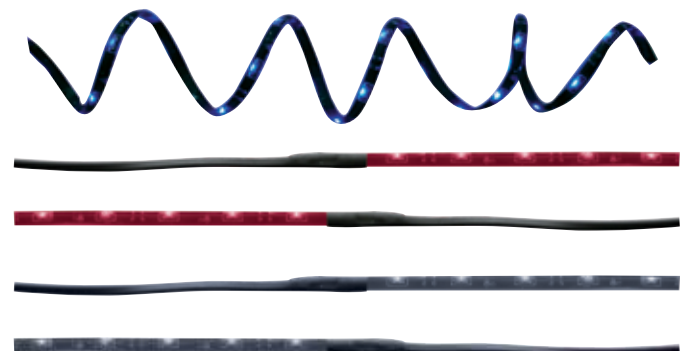



**1 LED Snap-In Indicator Light**

- Snap-in indicator light with 1 super bright LED
- Requires 1/4" diameter hole for installation
- 2 wire (hard wired), wire length approximately 7"

Item Number	LEDs	Lens	Package	Pack
36517B	1 Amber	Amber	Carded	1 Pc./Card
36518B	1 Blue	Clear	Carded	1 Pc./Card
36519B	1 Green	Green	Carded	1 Pc./Card
36520B	1 Red	Red	Carded	1 Pc./Card
36521B	1 White	Clear	Carded	1 Pc./Card



**11 LED Slim Strip Light**

- 11 high power white LED slim, low profile LED strip light

Item Number	LEDs	Lens	Package	Pack
37499B	11 White	Clear	Carded	1 Pc./Card



**Bluetooth RGB Multi-Color 500 Lumen LED Rock Light**

- Bluetooth app control with thousands of colors, dimming, strobe & beat to music on your IOS or Android device
- Plays millions of colors of light synchronized to the beat of the music from your smart phone
- Control & dim lights with RGB remote app
- CREE LED in a waterproof and aluminum housing
- Mounting pads & spacers, screws and instructions included
- Supports most iPhone, iPad and Android smartphones
- 500 lumens, 12V-24V multiple voltage
- Wire length: 11'
- Solids & Liquid protection rating: IP-67

Item Number	LEDs	Lens	Package	Pack
36604	1 Amber	Amber	Carded	1 Pc./Card



**LED ACCESSORY LIGHTS**  
**LED LIGHT BARS**

**19 LED 12" Reflector Turn Signal Light Bar**

- 19 LED 12" P/T/C reflector light bar, approximate size 12" L x 5/8" W
- Mounting holes approximately 11 7/16" apart



Item Number	LEDs	Lens	Package	Pack
39773	19 Amber	Amber	Carded	1 Pc./Card
39773B	19 Amber	Amber	Bulk	1 Pc.
39774	19 Red	Red	Carded	1 Pc./Card
39774B	19 Red	Red	Bulk	1 Pc.
39775	19 Amber	Clear	Carded	1 Pc./Card
39775B	19 Amber	Clear	Bulk	1 Pc.
39776	19 Red	Clear	Carded	1 Pc./Card
39776B	19 Red	Clear	Bulk	1 Pc.

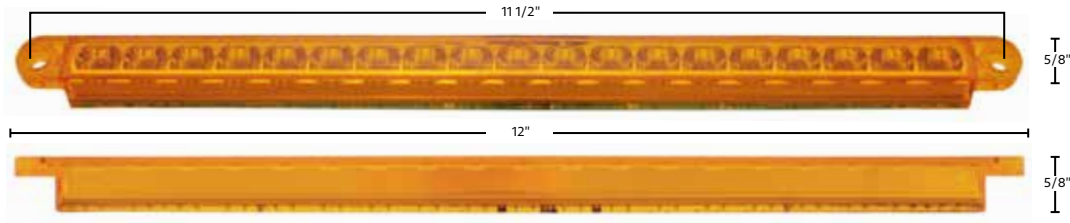

**14 LED 12" Reflector Turn Signal Light Bar**

- 14 LED 12" P/T/C strip light, 3 wire
- Mounting holes approximately 11 7/16" apart



Item Number	LEDs	Lens	Package	Pack
38946	14 Amber	Amber	Carded	1 Pc./Card
38946B	14 Amber	Amber	Bulk	1 Pc.
38947	14 Red	Red	Carded	1 Pc./Card
38947B	14 Red	Red	Bulk	1 Pc.
38948	14 Amber	Clear	Carded	1 Pc./Card
38948B	14 Amber	Clear	Bulk	1 Pc.
38949	14 Red	Clear	Carded	1 Pc./Card
38949B	14 Red	Clear	Bulk	1 Pc.
39483B	14 Blue	Clear	Bulk	1 Pc.
39484B	14 Green	Clear	Bulk	1 Pc.
39485B	14 White	Clear	Bulk	1 Pc.
39644B	14 Amber	Chrome	Bulk	1 Pc.
39645B	14 Red	Chrome	Bulk	1 Pc.

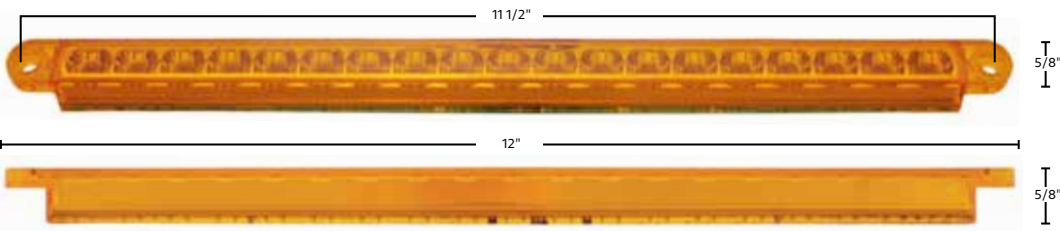

**12 LED 12" Ultra Slim Turn Signal Light Bar**

- Mounting holes approximately 11 1/2" apart



Item Number	LEDs	Lens	Package	Pack
38861B	12 Amber	Amber	Bulk	1 Pc.
38862B	12 Red	Red	Bulk	1 Pc.
38863B	12 Amber	Clear	Bulk	1 Pc.
38864B	12 Red	Clear	Bulk	1 Pc.

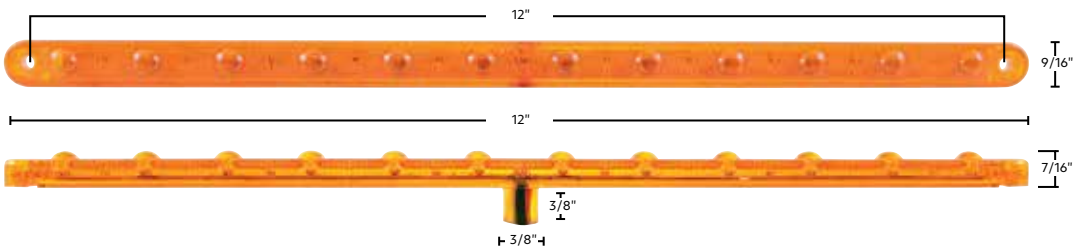

**10 LED 9" Turn Signal Light Bar**

- 10 LED 9" P/T/C strip light, 3 wire
- Mounting holes approximately 8 1/2" apart

Item Number	LEDs	Lens	Package	Pack
38942	10 Amber	Amber	Carded	1 Pc./Card
38942B	10 Amber	Amber	Bulk	1 Pc.
38943	10 Red	Red	Carded	1 Pc./Card
38943B	10 Red	Red	Bulk	1 Pc.
38944	10 Amber	Clear	Carded	1 Pc./Card
38944B	10 Amber	Clear	Bulk	1 Pc.
38945	10 Red	Clear	Carded	1 Pc./Card
38945B	10 Red	Clear	Bulk	1 Pc.
38005	10 White	Clear	Carded	1 Pc./Card

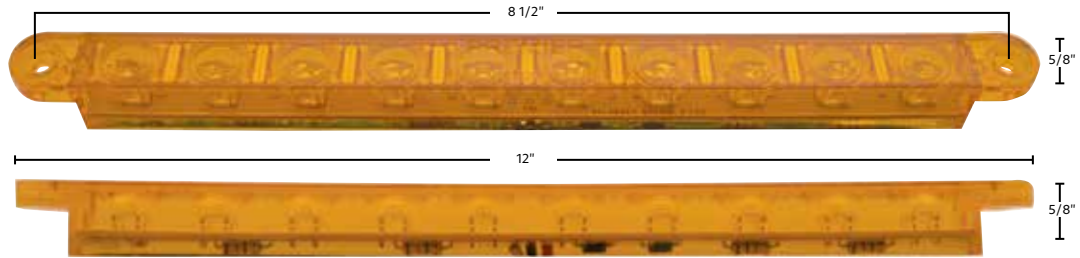
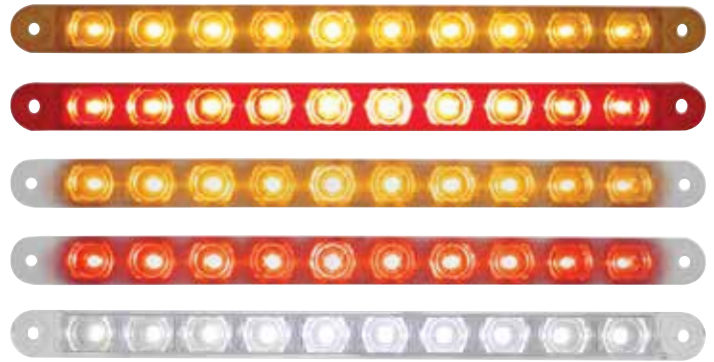

**10 LED 6 1/2" Turn Signal Light Bar**

- 10 LED 6 1/2" turn signal light bar, 3 wires (hard wired)
- Mounting holes approximately 6" apart

Item Number	LEDs	Lens	Package	Pack
39684B	10 Amber	Amber	Bulk	1 Pc.
39685	10 Red	Red	Carded	1 Pc./Card
39685B	10 Red	Red	Bulk	1 Pc.
39686	10 Amber	Clear	Carded	1 Pc./Card
39686B	10 Amber	Clear	Bulk	1 Pc.
39687	10 Red	Clear	Carded	1 Pc./Card
39687B	10 Red	Clear	Bulk	1 Pc.

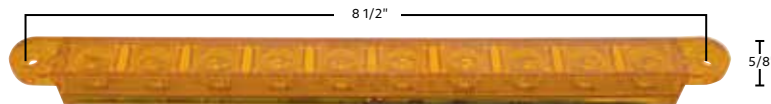
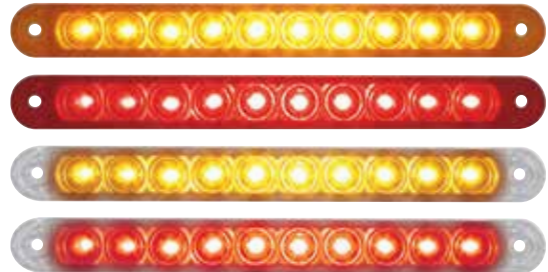

**5 LED 5" Light Strip With Hard Wire**

- 5 super bright SMD LED 5" light strip with fully sealed electronics
- 12VDC, dual function red or amber, or single function white
- Captive #6-32 nuts for rear flush mounted installation
- For clean and proper mounting, a 3-15/16x5/8" rectangular pocket is required, see line art for more dimensional details

Item Number	LEDs	Lens	Package	Pack
36446	5 Amber	Amber	Carded	1 Pc./Card
36447	5 Red	Red	Carded	1 Pc./Card
36448	5 White	Clear	Carded	1 Pc./Card

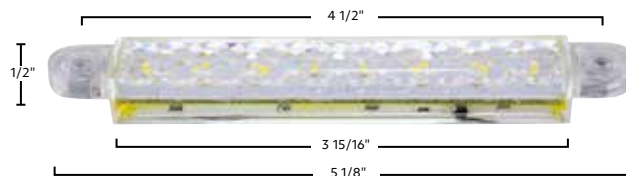

# LED LIGHT BARS W/ BEZEL

## 19 LED 12" Reflector Turn Signal Light Bar With Bezel

- 19 LED 12" reflector light bar with chrome plastic bezel
- Stainless steel mounting hardware included
- Mounting screws can be moved to accommodate mounting distance from 4 1/2" - 7 3/8" apart
- 12" chrome plastic light bar bezel available separately: item # 30933B

Item Number	LEDs	Lens	Light	Pack
37940	19 Amber	Amber	39773B	1 Pc./Card
37941	19 Red	Red	39774B	1 Pc./Card
37942	19 Amber	Clear	39775B	1 Pc./Card
37943	19 Red	Clear	39776B	1 Pc./Card

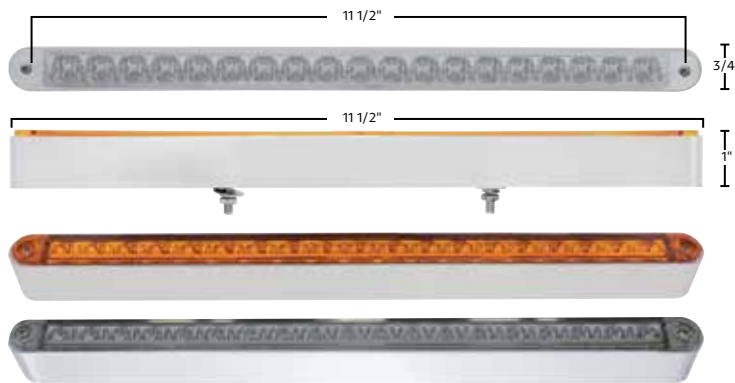
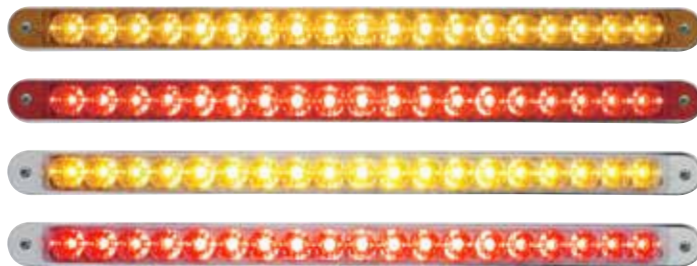

## 14 LED 12" Turn Signal Light Bar W/ Bezel

- 14 LED 12" light bar with chrome plastic bezel
- Stainless steel hardware included
- Mounting holes can be moved to accommodate mounting distance from 4 1/2" - 7 3/8" apart

Item Number	LEDs	Lens	Light	Pack
39606	14 Amber	Amber	38946B	1 Pc./Card
39608	14 Amber	Clear	38948B	1 Pc./Card
39607	14 Red	Red	38947B	1 Pc./Card
39609	14 Red	Clear	38949B	1 Pc./Card
39804	14 Blue	Clear	39483B	1 Pc./Card
39805	14 Green	Clear	39484B	1 Pc./Card
39806	14 White	Clear	39485B	1 Pc./Card
39698	14 Amber	Chrome	39644B	1 Pc./Card
39699	14 Red	Chrome	39645B	1 Pc./Card

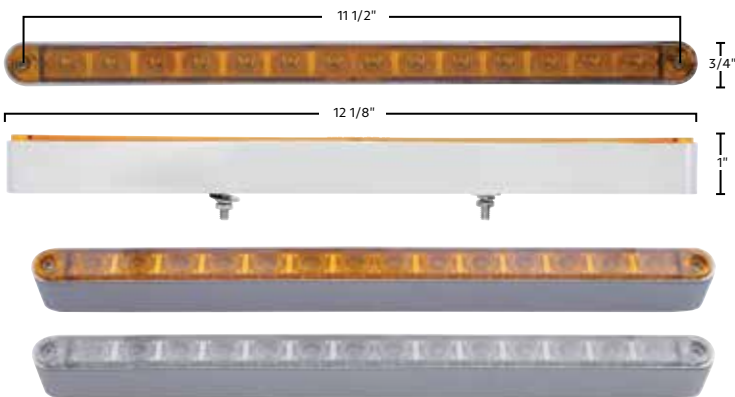
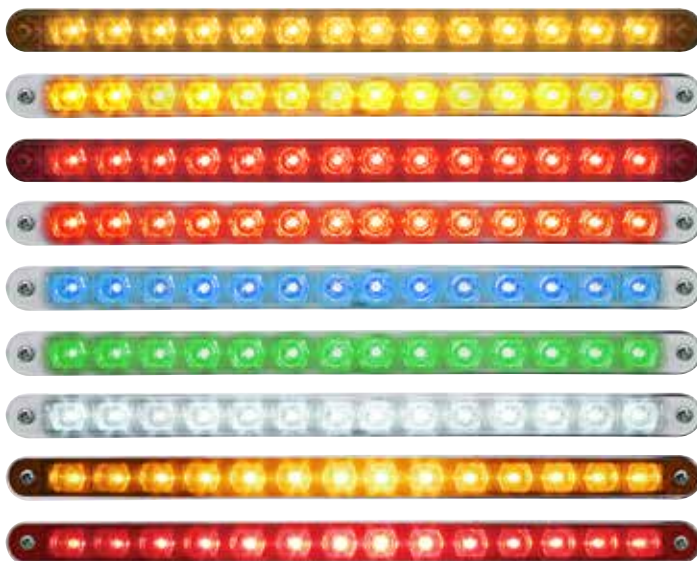

**10 LED 9" Turn Signal Light Bar W/ Bezel**

- 10 LED 9" light bar with quality polycarbonate lens
- Beautiful chrome plated plastic bezel
- Mounting screws can move to accommodate mounting distance from 4 1/2" - 7 3/8" apart

Item Number	LEDs	Lens	Light	Pack
39306	10 Amber	Amber	38942B	1 Pc./Card
39307	10 Red	Red	38943B	1 Pc./Card
39308	10 Amber	Clear	38944B	1 Pc./Card
39309	10 Red	Clear	38945B	1 Pc./Card

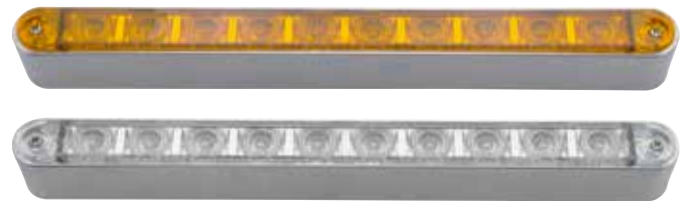
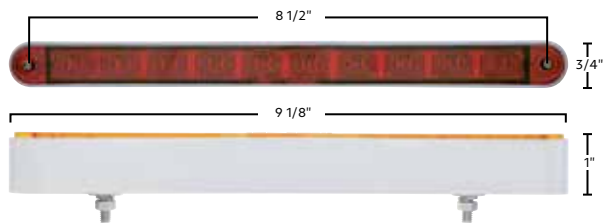

**10 LED 6 1/2" Turn Signal Light Bar W/ Bezel**

- 10 LED 6 1/2" light bar with quality polycarbonate lens
- Beautiful chrome plated plastic bezel
- Mounting screws can move to accommodate mounting distance from 2 1/4" - 4 7/8" apart

Item Number	LEDs	Lens	Light	Pack
37637	10 Amber	Amber	39684B	1 Pc./Card
37638	10 Red	Red	39685B	1 Pc./Card
37639	10 Amber	Clear	39686B	1 Pc./Card
37640	10 Red	Clear	39687B	1 Pc./Card

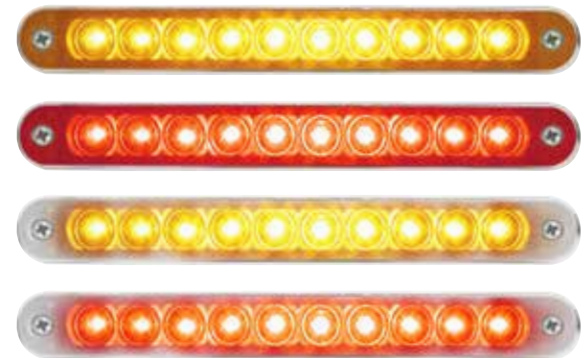
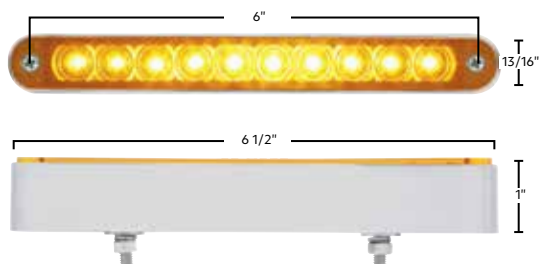

**LED ACCESSORY LIGHTS**  
**LED LICENSE LIGHT**

**19 LED 12" Light Bar Chrome License Plate Frame**

- Beautiful high quality chrome plated finish with triple chrome plating process
- Designed for all 12V application

Item Number	LEDs	Lens	Package	Pack
<b>37946</b>	19 Amber	Amber	Bulk	1 Pc./Card
<b>37947</b>	19 Red	Red	Bulk	1 Pc./Card
<b>37948</b>	19 Red	Clear	Bulk	1 Pc./Card
<b>37949</b>	19 Red	Clear	Bulk	1 Pc./Card



**14 LED Dual Light Bar Chrome License Plate Frame**

- 14 super bright white LEDs with clear polycarbonate lens
- Solid state circuit boards are designed for 7.7-14.0V DC, 1156 plug
- Perfect solution for back-up lights on Corvettes converted to 4 tail lights, hardware included

Item Number	LEDs	Lens	Package	Pack
<b>50121</b>	14 White	Clear	Carded	1 Pc./Card
<b>50122</b>	14 Red	Clear	Carded	1 Pc./Card



**14 LED Light Bar Chrome License Plate Frame**

- Beautiful high quality chrome plated finish with triple chrome plating process
- Designed for all 12V application

Item Number	LEDs	Lens	Package	Pack
<b>39743</b>	14 Amber	Amber	Bulk	1 Pc./Card
<b>39744</b>	14 Red	Red	Bulk	1 Pc./Card
<b>39781</b>	14 White	Clear	Bulk	1 Pc./Card

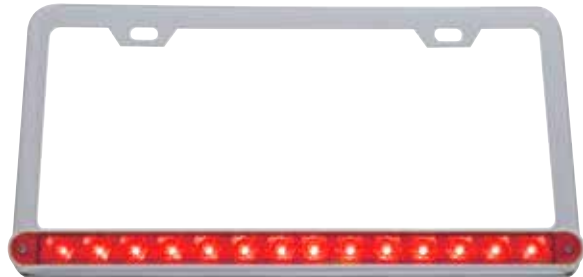
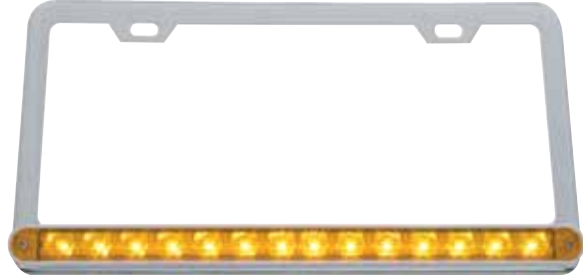

**10 LED Chrome Deluxe License Plate Frame**

- Beautiful chrome plated finish with triple chrome plating process
- New deluxe vintage style with 10 white LEDs and clear lens
- Designed for all 12V applications

Item Number	LEDs	Lens	Package	Pack
<b>36541</b>	10 White	Clear	Carded	1 Pc./Card



**LED Chrome License Plate Frame W/ LED Auxiliary Light**

- Deluxe chrome license plate frame with LED back-up light and white LED license light
- Beautiful chrome die cast metal light housing with 5 LED light, and 11 LED license plate light
- Fits standard U.S. & Canadian 6" x 12" license plates
- Overall frame dimension 12-5/16" x 6-3/8"

Item Number	LEDs	Lens	Package	Pack
50148	5 Red/10 White	White	Carded	1 Pc./Card
50149	5 Amber/10 White	Amber	Carded	1 Pc./Card
50187	5 White/10 White	White	Carded	1 Pc./Card



**10 LED 9" Light Bar Chrome License Plate Frame**

- Beautiful high quality chrome plated finish with triple chrome plating process
- Designed for all 12V application

Item Number	LEDs	Lens	Package	Pack
39755	10 Amber	Amber	Bulk	1 Pc.
39756	10 Red	Red	Bulk	1 Pc.
39757	10 Amber	Clear	Bulk	1 Pc.
39758	10 Red	Clear	Bulk	1 Pc.

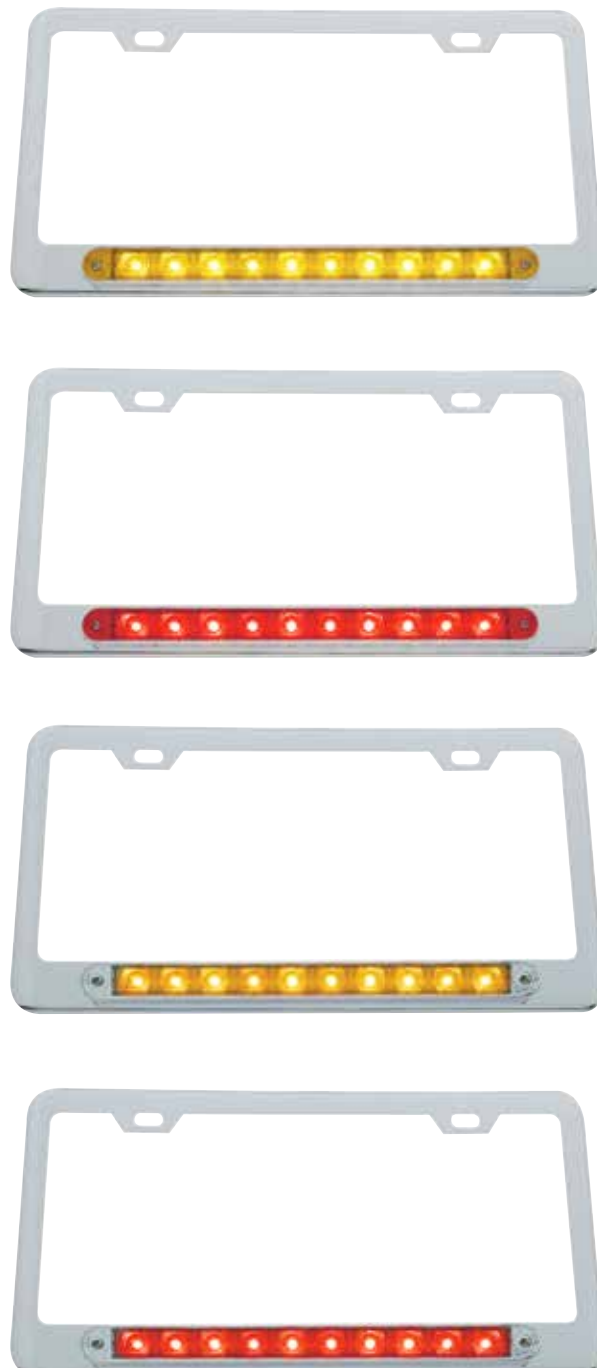

**LED ACCESSORY LIGHTS**  
**LED LICENSE LIGHT**

**Chrome License Plate Frame W/ 24 LED GLO Light**

- Beautiful high quality chrome plated finish with triple chrome plating process
- Easy hookup to your existing brake light switch, 12V application
- Fits standard U.S. & Canadian 6" x 12" license plates

Item Number	LEDs	Lens	Package	Pack
36497	24 Red	Red	Carded	1 Pc./Card
36498	24 Red	Clear	Carded	1 Pc./Card



**Chrome Deluxe License Plate W/ Split Turn Function**

- Chrome license plate with 10 LED 9 split turn function light bar
- Dual function 10 LED running light & 5 LED left hand & 5 LED right hand turn signal
- Easy electrical hookup w/ 4 wires: ground, tail, L/H high, R/H high
- Includes stainless steel mounting hardware

Item Number	LEDs	Lens	Package	Pack
39397	10 Red	Red	Carded	1 Pc./Card



**Black License Plate Frame W/ 24 LED GLO Light**

- Gloss black powder coated plastic license plate frame and plastic light bar housing
- 12V application, easy hookup to your existing auxiliary wiring
- Fits standard U.S. & Canadian 6" x 12" license plates

Item Number	LEDs	Lens	Package	Pack
36480	24 Amber	Amber	Carded	1 Pc./Card
36482	24 Amber	Clear	Carded	1 Pc./Card
36481	24 Red	Red	Carded	1 Pc./Card
36483	24 Red	Clear	Carded	1 Pc./Card





**14 LED Black License Plate Frame W/ 12" Light Bar**

- Gloss black powder coated plastic license plate frame and plastic light bar housing
- 12V application, easy hookup to your existing auxiliary wiring
- Fits standard U.S. & Canadian 6" x 12" license plates

Item Number	LEDs	Lens	Package	Pack
36472	14 Amber	Amber	Carded	1 Pc./Card
36474	14 Amber	Clear	Carded	1 Pc./Card
36473	14 Red	Red	Carded	1 Pc./Card
36475	14 Red	Clear	Carded	1 Pc./Card
36496	14 White	Clear	Carded	1 Pc./Card



**19 LED Black License Plate Frame W/ 12" Light Bar**

- Gloss black powder coated plastic license plate frame and plastic light bar housing
- 12V application, easy hookup to your existing auxiliary wiring
- Fits standard U.S. & Canadian 6" x 12" license plates

Item Number	LEDs	Lens	Package	Pack
36476	19 Amber	Amber	Carded	1 Pc./Card
36478	19 Amber	Clear	Carded	1 Pc./Card
36477	19 Red	Red	Carded	1 Pc./Card
36479	19 Red	Clear	Carded	1 Pc./Card



**LED ACCESSORY LIGHTS**  
**LED LICENSE LIGHT**

**6 LED Stainless Steel Tube Light**

- 6 LED stainless tube light, universal application, install anywhere
- Highly polished 304 stainless steel finish for durability and shine
- Mounting studs are approximately 8" apart
- Designed for all 12V application, 2 wires (hard wired)

Item Number	LEDs	Lens	Package	Pack
37586	6 Amber	Clear	Carded	1 Pc./Card
37587	6 Blue	Clear	Carded	1 Pc./Card
37588	6 Red	Amber	Carded	1 Pc./Card



**6 LED Stainless Steel Tube Light**

- 6 LED stainless tube light, universal application, install anywhere
- Highly polished 304 stainless steel finish for durability and shine
- Mounting studs are approximately 8" apart
- Designed for all 12V application, 2 wires (hard wired)

Item Number	LEDs	Lens	Package	Pack
S2008LED	6 White	Clear	Carded	1 Pc./Card

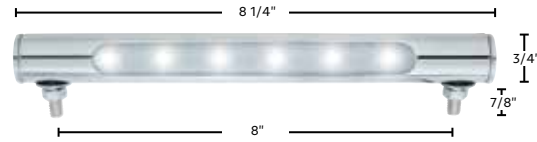

**2 LED Chrome License Plate Light/Utility Light**

- 2 super bright white LED license/utility light, 12 volt
- Water resistant chrome housing
- Includes mounting screws and pad
- Mounting screws are 5-1/2" apart

Item Number	LEDs	Lens	Package	Pack
39909	2 White	Clear	Carded	1 Pc./Card



**4 LED License Light**

- 4 super bright LED utility/license light
- Chrome housing, water resistant
- Install anywhere
- 2 wires (hard wired)

Item Number	LEDs	Lens	Package	Pack
39930	4 White	Clear	Carded	1 Pc./Card



**2 LED License Light**

- 2 white LED auxiliary/license light

Item Number	LEDs	Lens	Package	Pack
39994B	2 White	Clear	Carded	1 Pc./Card





**11 LED Chrome License Plate Frame**

- Show quality chrome plated die-cast license bracket
- 11 bright white LED license plate light
- 5 bright LED rear facing auxiliary light
- Mounts to any surface with 2 mounting studs on back

Item Number	LEDs	Lens	Package	Pack
S2007LED-A	11 White/5 Amber	Amber	Carded	1 Pc./Card
S2007LED	11 White/5 Red	Red	Carded	1 Pc./Card
S2007LED-W	11 White/5 White	Clear	Carded	1 Pc./Card



**11 LED Chrome License Plate Light**

- Beautiful chrome die-cast art-deco design light housing
- 11 bright white LED license plate light
- 5 bright LED rear facing auxiliary light
- Mounting screws are 5-1/2" apart
- Includes mounting pad with lip and mounting hardware

Item Number	LEDs	Lens	Package	Pack
110265	11 White/5 Amber	Amber	Carded	1 Pc./Card
110203	11 White/5 Red	Red	Carded	1 Pc./Card
110204	11 White/5 White	Clear	Carded	1 Pc./Card



**4 LED Round License Light**

- 4 bright white LED round license plate light, simple universal auxiliary license plate light design
- Requires 12V power and can be mounted horizontal, vertical, on or off the license plate frame

Item Number	LEDs	Lens	Package	Pack
39995B	4 White	Clear	Carded	1 Pc./Card



1928 Ford Model "A" Style

**LED Tail Lights - Horizontal**

- Bobber style LED 1928 Ford Model "A" tail light w/ LED license light
- Bright red LEDs with red glass lens and black license bracket
- Perfect for custom motorcycles

Item Number	LEDs	Lens	Rim/Housing	Pack
<b>86819</b>	19 Red 4 White	Red/Clear	Black/Black	1 Pc./Box
<b>86817</b>	19 Red 4 White	Red/Clear	Stainless Steel/ Black	1 Pc./Box
<b>86815</b>	19 Red 4 White	Red/Clear	Stainless Steel	1 Pc./Box



86819



86817



86815

1932 Ford Style

**LED Tail Light - Horizontal W/ Stainless Rim & Housing**

- Bobber style LED 1932 Ford tail light w/ LED license light
- Bright red LEDs with red glass lens and black license bracket
- Perfect for custom motorcycles

Item Number	LEDs	Lens	Rim/Housing	Pack
<b>86821</b>	19 Red 4 White	Red/Clear	Stainless Steel	1 Pc./Box



1933 Ford Style

**LED Tail Lights - Horizontal**

- Bobber style LED 1933 Ford tail light w/ LED license light
- Bright red LEDs with red glass lens and black license bracket
- Perfect for custom motorcycles

Item Number	LEDs	Lens	Rim/Housing	Pack
<b>86824</b>	19 Red 4 White	Red/Clear	Black/Black	1 Pc./Box
<b>86823</b>	19 Red 4 White	Red/Clear	Stainless Steel/ Black	1 Pc./Box



86823



86824

**LED LIGHT BULBS**  
**1157 BULBS**

**2 High Power LED 1157 Bulbs**

- Bright 2 watt Osram LED, 250 lumens
- Double contact, offset pin

Item Number	LEDs	Lens	Package	Pack
36932	2	Amber	Carded	1 Pc./Card
36934	2	Red	Carded	1 Pc./Card
36935	2	White	Carded	1 Pc./Card



**8 High Power LED 1157 Bulb (2 Pack)**

- 8 high power SMD LED's, 50 lumens/150/lumens
- Replaces most #1157 and #P21/5W applications
- 12 volt, double contact with off-set pins

Item Number	LEDs	Lens	Package	Pack
36445	8 Amber	Amber	Carded	2 Pcs./Card
36444	8 Red	Red	Carded	2 Pcs./Card
36443	8 White	White	Carded	2 Pcs./Card

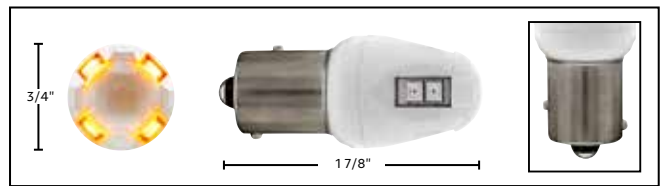

**High Power 1157 LED Bulb**

- Dual function LED bulb: high 275 lumens/low 150 lumens
- 360 degrees surround illumination, 180 degree front illumination
- Long life sealed design

Item Number	LEDs	Lens	Package	Pack
36469	1 Amber	Amber	Carded	1 Pc./Card
36470	1 Red	Red	Carded	1 Pc./Card
36471	1 White	White	Carded	1 Pc./Card

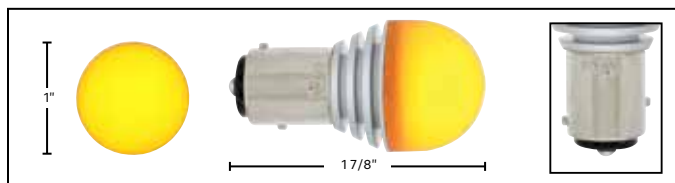

**13 LED 360 Degree 1157 Bulb**

- 13 LED 360 degree 1157 bulb
- 1157 double contact, offset pin

Item Number	LEDs	Lens	Package	Pack
39862	13 Amber	Amber	Carded	1 Pc./Card

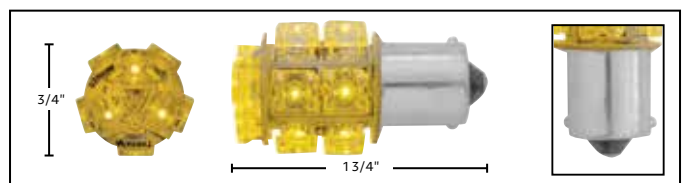

**8 High Power LED 1156 Bulb (2 Pack)**

- 8 high power SMD LED's, 250 lumens
- Replaces most #1156 and #89 applications
- 12 volt, single contact straight across pins

Item Number	LEDs	Lens	Package	Pack
<b>38899</b>	8 Amber	Amber	Carded	2 Pcs./Card
<b>38898</b>	8 Red	Red	Carded	2 Pcs./Card
<b>38897</b>	8 White	Amber	Carded	2 Pcs./Card



**2 High Power LED 1156 Bulbs**

- Bright 2 watt Osram LED, 250 lumens
- Single contact, straight pin

Item Number	LEDs	Lens	Package	Pack
<b>36928</b>	2	Amber	Carded	1 Pc./Card
<b>36930</b>	2	Red	Carded	1 Pc./Card
<b>36931</b>	2	White	Carded	1 Pc./Card

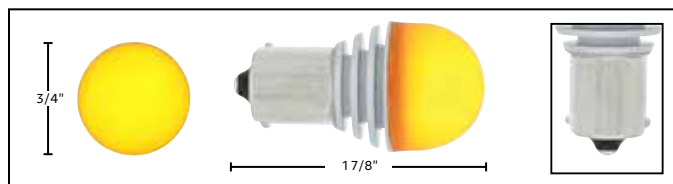

**High Power 1156 LED Bulb**

- Single function LED bulb with maximum 275 lumens
- 360 degrees surround illumination, 180 degree front illumination
- Long life sealed design

Item Number	LEDs	Lens	Package	Pack
<b>36465</b>	1 Amber	Amber	Carded	1 Pc./Card
<b>36466</b>	1 Red	Red	Carded	1 Pc./Card
<b>36467</b>	1 White	White	Carded	1 Pc./Card

**LED LIGHT BULBS**  
**194 BULBS**

**4 LED 194 Bulb (3 Pack)**

- Standard 194 wedge base
- Deluxe packaging with 3 bulbs per card

Item Number	LEDs	Lens	Package	Pack
38272	4	Amber	Carded	3 Pcs./Card
38273	4	Blue	Carded	3 Pcs./Card
38274	4	Green	Carded	3 Pcs./Card
38276	4	Red	Carded	3 Pcs./Card
38277	4	White	Carded	3 Pcs./Card

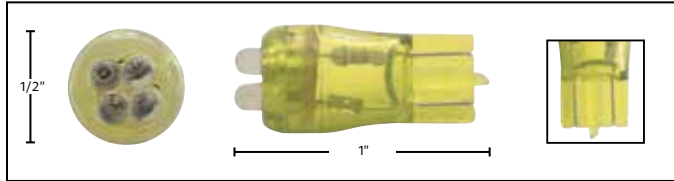

**1 LED 194 Bulb (2 Pack)**

- Single Cree LED
- Single contact, straight pin

Item Number	LEDs	Lens	Package	Pack
36917	1 Amber	Clear	Carded	2 Pcs./Card
36918	1 Blue	Clear	Carded	2 Pcs./Card
36919	1 Red	Clear	Carded	2 Pcs./Card
36920	1 White	Clear	Carded	2 Pcs./Card



**1 Micro LED 37/BP2 Bulb (2 Pack)**

- Popular on most dash applications
- Standard 37/bp2 wedge base

Item Number	LEDs	Lens	Package	Pack
38343	1	Amber	Carded	2 Pcs./Card
38344	1	Blue	Carded	2 Pcs./Card
38345	1	Green	Carded	2 Pcs./Card
38346	1	Purple	Carded	2 Pcs./Card
38348	1	White	Carded	2 Pcs./Card



**4 Micro LED 194 Bulb (2 Pack)**

- Standard 194 wedge base

Item Number	Micro LEDs	Lens	Package	Pack
38288	4 Purple	Purple	Carded	2 Pcs./Card

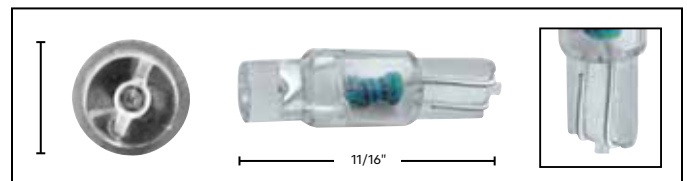





**13 LED 3157 Bulb**

- Epoxy coated fully sealed electronics
- Single contact, straight pin

Item Number	LEDs	Lens	Package	Pack
37800	5	Amber	Carded	2 Pcs./Card
37801	5	Blue	Carded	2 Pcs./Card
37802	5	Red	Carded	2 Pcs./Card
37803	5	White	Carded	2 Pcs./Card

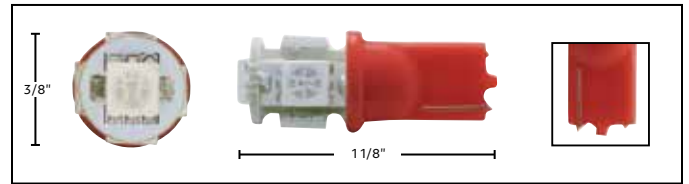

**2 High Power LED 3157 Bulb**

- Super bright 2W LED
- Output rated at 250 lumens
- 3157 wedge base

Item Number	LEDs	Lens	Package	Pack
36547	4 Amber	Clear	Carded	1 Pc./Card
36549	4 Red	Clear	Carded	1 Pc./Card
36550	4 White	Clear	Carded	1 Pc./Card



**2 High Power LED 3156 Bulb**

- Super bright 2W LED
- Output rated at 250 lumens
- 3156 wedge base

Item Number	LEDs	Lens	Package	Pack
36543	2 Amber	Amber	Carded	1 Pc./Card
36545	2 Red	Red	Carded	1 Pc./Card



**LED LIGHT BULBS**  
**1893/211-1/912 BULBS**

**1 LED 1893 Bulb (2 Pack)**

- 1893 bulb with 1 large 10mm LED bulb
- Single contact, straight pin

Item Number	LEDs	Lens	Package	Pack
38565	1	White	Carded	2 Pcs./Card

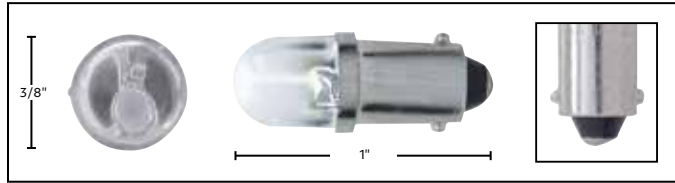

**4 Micro LED 1893 Bulb (2 Pack)**

- 1893 bulb with 4 micro LED bulbs, single contact, straight pin

Item Number	Micro LEDs	Lens	Package	Pack
38566	4	Amber	Carded	2 Pcs./Card
38567	4	Blue	Carded	2 Pcs./Card
38568	4	Green	Carded	2 Pcs./Card
38570	4	Red	Carded	2 Pcs./Card
38571	4	White	Carded	2 Pcs./Card



**7 White LED 912/921 Bulb**

- 912/921 wedge base, also fits 194 socket
- Light output is estimated at 34 lumens

Item Number	LEDs	Lens	Package	Pack
36504	7 White	White	Carded	1 Pc./Card

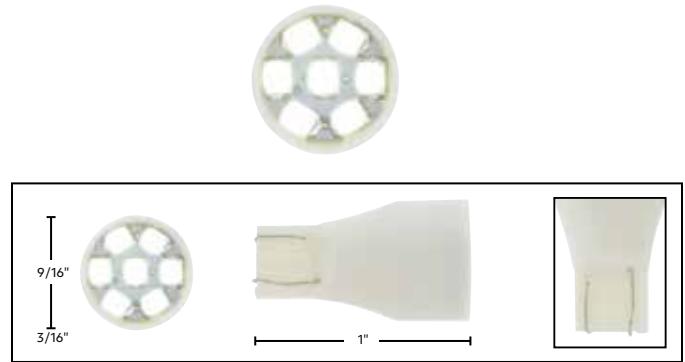

**6 SMD High Power LED 6418-6461 36mm Bulb (2 Pack)**

- Standard T-3 festoon base
- Specially designed bulb projects light 160 degrees

Item Number	LEDs	Lens	Package	Pack
36591	6 Amber	Amber	Carded	2 Pcs./Card
36592	6 Blue	Blue	Carded	2 Pcs./Card
36593	6 Red	Red	Carded	2 Pcs./Card
36594	6 White	White	Carded	2 Pcs./Card

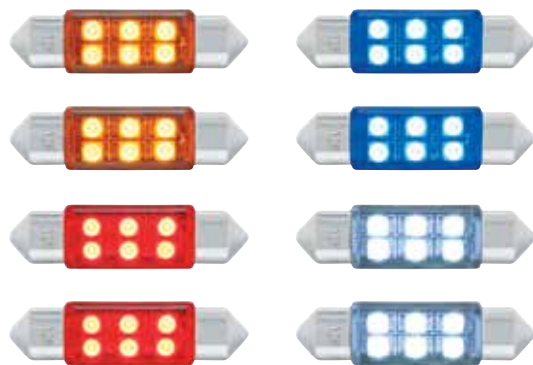

**8 SMD High Power LED 211-1 Bulb (2 Pack)**

- Perfect upgrade for dome lights that use a 211-2 bulb
- Specially designed bulb projects light 160 degrees
- Standard T-3 festoon base, 43.7mm length, 8.5mm dia, 12VDC

Item Number	LEDs	Lens	Package	Pack
36595	8 Amber	Amber	Carded	2 Pcs./Card
36596	8 Blue	Blue	Carded	2 Pcs./Card
36597	8 Red	Red	Carded	2 Pcs./Card
36598	8 White	White	Carded	2 Pcs./Card



**LED Flasher W/ Reverse Polarity Base & Extension Wires**

- Designed for all 12V applications, 20 amp maximum
- Solves turn signal problems, such as hyper flashing, no flashing, or burnt out bulb indication when using LED lights and bulbs
- Includes polarity reversing base & extension wires

Item Number	Description	Package	Pack
90649	LED Flasher - 2 Terminal	Carded	1 Pc./Card



**LED Flashers - 12V, Terminal**

- For use with all vehicles that are changed to LED tail lights and front turn signals
- Single contact, straight pin

Item Number	Description	Package	Pack
90651	LED Flasher - 3 Terminal	Carded	1 Pc./Card



**LED Flasher With Polarity Reversing Adapter 12V**

- For use with all vehicles that are changed to LED tail lights and front turn signals, plug & play
- Simply replaces the original 552, or 536 under dash flasher
- Includes 2-terminal flasher (90650), polarity reversing adapter (90650a)
- Polarity reversing adapter solves reversed issues on some applic.

Item Number	Description	Package	Pack
90652	12V Flasher & Adapter	Carded	1 Pc./Card



**Sequential LED Light Kit**

- This kit will convert three 12 volt LED tail lights to sequential operation
- Kit includes two sequencer modules, hookup wire, wire connectors and instructions
- Designed for pre 1970's classic applications
- Also works with United Pacific LED tail lights for 1969 Camaro, 1967-68 Mustang and 1969 Mustang
- Not for use on vehicles with factory cruise control, alarm systems, or ABS brakes
- Not for use on vehicles that tow trailer, and not for use on trailers
- Not for use with incandescent light bulbs (LED only)
- Installation requires knowledge of automotive electrical systems

Item Number	Description	Package	Pack
90656	Sequential Light Kit	Kit	1 Kit

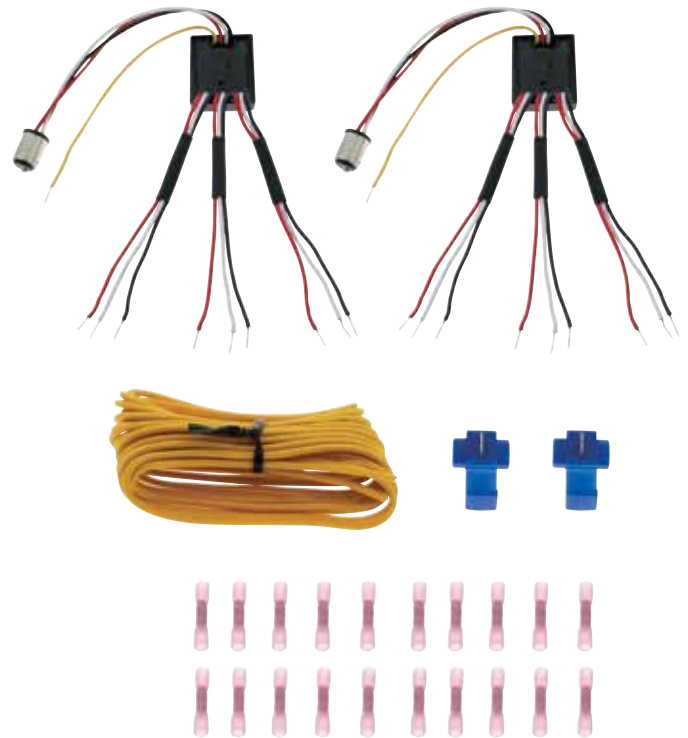

**Polarity Reversing Adapter**

- Polarity reversing adapter for UP 90650 turn signal flasher
- Reverses "X" and "I" terminals without modifying vehicle wiring

Item Number	Description	Package	Pack
90650A	Polarity Adapter	Carded	1 Pc./Card



# FLASHERS/LOAD RESISTORS

## Load Resistor - 50 Watt, 6 OHM

- Sends higher amperage to headlights
- Corrects dim lights on classic cars and hot rods
- Works on original style 6014 sealed beams
- Select proper kit to match your type of headlamp bulbs
- 12 volt application

Item Number	Description	Package	Pack
34263	H4 Relay Harness	Bulk	1 Pc.
34264	9005/9006 Relay Harness	Bulk	1 Pc.
34265	9007 Relay Harness	Bulk	1 Pc.

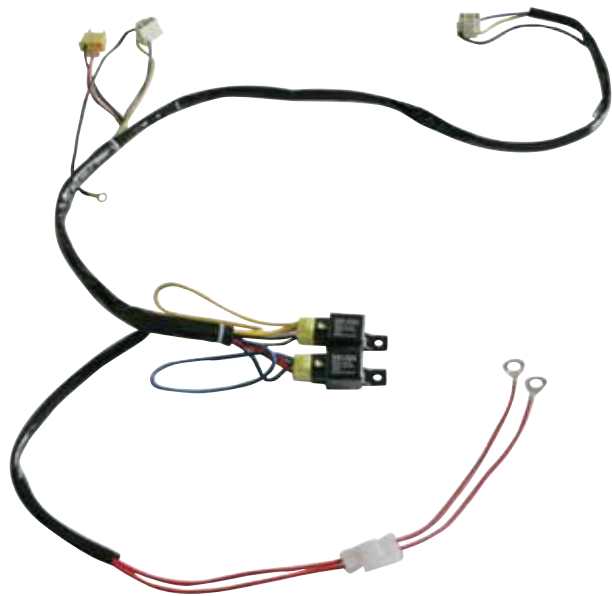

## Load Resistor - 50 Watt, 6 OHM

- Simulate the load of an incandescent bulb
- Eliminate LED turn signal and LED headlight problems, such as hyper flashing, no flashing or burnt out bulb indication
- Aluminum housing with proprietary heat management allows installation in most locations
- Mounting hardware included
- Includes one load resistor and 2 connectors

Item Number	Description	Package	Pack
34205	Load Resistor	Carded	1 Pc./Card

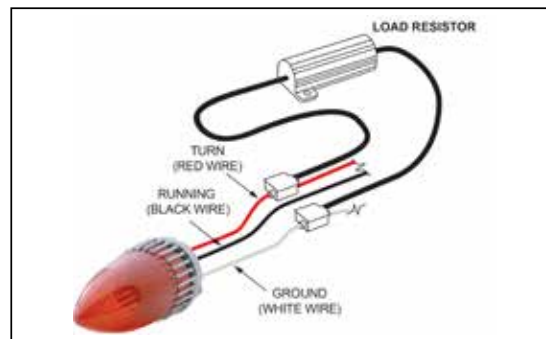

## Brake Attention Module

- Upon applying the brakes, this electronic device rapidly flashes the third brake light (or both brake lights) for a second or two to gain the attention of the driver behind you
- Maximum capacity of 1.5 amp
- Easy hookup instructions included, 12 volt

Item Number	Description	Package	Pack
90655	Polarity Adapter	Carded	1 Pc./Card

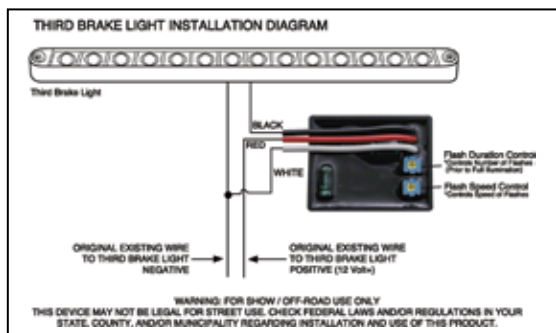

## Load Resistor Kit Solves LED Issue - 50 Watt/6 OHM

- 50W/6 OHM LED load resistors for LED turn signal lights or LED license plate lights
- Eliminate LED turn signal problems, such as hyper flashing, no flashing, or burnt out bulb indication
- Simulates the load of an incandescent bulb to solve LED issues
- Aluminum housing with proprietary heat management allows installation in most locations
- Kit includes two load resistors and 4 connectors

Item Number	Description	Package	Pack
34235	Load Resistor Kit	Box	2 Pcs./Box



**Fog Lamp Wiring Harness**

- Complete wire harness from dash switch fog lamps
- Relay safety handles high amperage draw from fog lights
- 12 volt application

Item Number	Description	Package	Pack
34266	Fog Lamp Wiring Harness	Carded	1 Pc./Card

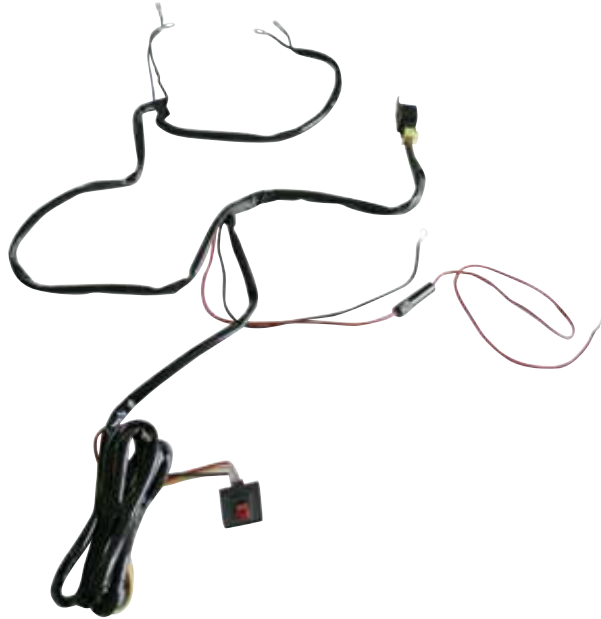

**72" Chrome Plastic Wire Looms**

**1/4" Diameter**

Item Number	Diameter	Color	Package	Pack
34800	1/4"	Chrome	Hang Pack	1 Pc./Pack

**3/8" Diameter**

Item Number	Diameter	Color	Package	Pack
34801	3/8"	Chrome	Hang Pack	1 Pc./Pack

**1/2" Diameter**

Item Number	Diameter	Color	Package	Pack
34802	1/2"	Chrome	Hang Pack	1 Pc./Pack

**5/8" Diameter**

Item Number	Diameter	Color	Package	Pack
34803	5/8"	Chrome	Hang Pack	1 Pc./Pack

**3/4" Diameter**

Item Number	Diameter	Color	Package	Pack
34804	3/4"	Chrome	Hang Pack	1 Pc./Pack



**LED Flasher/Warning Module With 24 Flash Patterns**

- Converts regular LED lights into flashing warning lights
- 24 selectable flash patterns, sync or alternating flash
- 12V application, 2 outputs, 20 amp max draw
- 1 module works with 2 LED lights

Item Number	Description	Package	Pack
90660	LED Warning Module	Carded	1 Pc./Card



**Plug Adaptor For Tail Lamp Socket**

- 3 wire 1157 double contact plug adaptor with 5' of wire
- and 2 wire 1156 single contact style adaptor with 5' of wire

Item Number	Description	Package	Pack
FTL1157-PLUG	3 Wire Plug	Bag	1 Pc./Bag
FTL1156-PLUG	2 Wire Plug	Bag	1 Pc./Bag



**100" Chrome Plastic Wire Looms**

**1/4" Diameter**

Item Number	Diameter	Color	Package	Pack
34815	1/4"	Chrome	Hang Pack	1 Pc./Pack

**1/2" Diameter**

Item Number	Diameter	Color	Package	Pack
34817	1/2"	Chrome	Hang Pack	1 Pc./Pack



# TERMS & CONDITIONS/ORDERING/FREIGHT

## Terms and Conditions for Wholesale

### New Accounts

Initial buy-in amount and/or quantity is to be determined by United Pacific Industries, UPI hereafter. All initial orders must be prepaid in advance by Cashier's Check or VISA/MC/AMX. All new/potential accounts must complete a UPI "New Dealer Info/Credit Form" and follow the Dealer Qualification Instructions. Upon completion of the credit application, approved accounts will be assigned payment terms of NET 30 Days (from invoice date). Accounts denied a credit line will be required to prepay in advance by Cashier's Check, ACH or Bank wire or VISA/MC/AMX.

## Payment Terms

### Term Accounts

Accounts with NET 30 Days terms are required to submit payment within the 30 days from the date of invoice. Acceptable forms of payment include checks, ACH (Automated Clearing House), or wire transfer. A service charge of 1.5% per month will be imposed on invoices not paid within the 30-day term. Delinquent accounts will be required to pay Cash-In-Advance (CIA). Checks will be accepted but orders will not be released until the check is cleared by the bank. Past due invoices will delay current orders. Please check with UPI on your account status when placing an order.

### Credit Cards

Accounts denied credit terms may be given the option to pay by Visa, MasterCard or American Express. The credit card will be charged upon shipment. A 3% service fee will be added to the invoice. Credit card payments will not be accepted once an order has been shipped. UPI does not accept Discover card.

### COD

There is no COD payment offered.

### Returned Checks

A \$30.00 NSF (Non-Sufficient Fund) fee will be assessed on each incidence a check is returned to UPI.

## Ordering Guidelines

### Placing Orders

New orders and PO's may be placed by any of the following methods:

- Fax: (888) 986-5988
- E-mail: [antique@upauto.com](mailto:antique@upauto.com)
- Telephone: In order to minimize errors, dealers are encouraged to submit their orders by fax or mail. Telephone orders are generally not preferred as to minimize errors. Utilize one of the methods above for placing orders.

### Changes to Orders

Once orders are released for picking, changes are no longer possible. Dealers would have to submit a new PO for any additional items needed.

### Cancelling Orders

Cancellation of Stock orders must be submitted via fax or email within 24 hours of the order date. If the Stock order has already shipped it will be the dealer's responsibility to return the order at the dealer's own expense. A restocking fee may apply, please see "Return" policy for further detail. Drop Ship orders cannot be canceled due to the priority processing and shipping.

### Backorders

Dealers have the option of having their backorders shipped or canceled. UPI will notify dealer as to availability of backorders and will be able to ship any backorder items dealer still needs as part of their next stock order. UPI reserves the right to cancel backorders that are 2 month or older from invoice date.

### Minimum Orders

A minimum order of \$50.00 is required. Orders below \$50.00 will be assessed a minimum order fee of \$10.00.

### Packaging

A 10% service charge will be added to orders with special packaging or UPC barcoding requirements.

### Lead Times

Standard lead time for all United Pacific Stock orders is 5 business days from the receipt of the purchase order. Larger Stock orders may require a lead time of up to 7 business days. Drop Ship orders generally ship in 2 business days or less. Transit time of 3-5 business days must be considered when placing orders. UPI cannot be responsible for delays in shipment after an order leaves our warehouse. UPI will work to resolve delays with freight forwarding firms, however, delays do arise from time to time due to weather and unforeseen circumstances beyond UPI's control. Express orders are exempt; please view Freight/Shipping Policy for further detail.

### Order Confirmation

United Pacific will acknowledge receipt of orders by email or EDI within 1 business day of receiving the PO. If confirmation is not received, please contact UPI to ensure your order was received.

## Freight

### Prepaid Freight

Stock orders between \$.01 and \$1,999.99 (US Lower 48 States and Canada), \$.01 and \$3,299.99 (Alaska and Hawaii), [all price net US\$], will be shipped FOB Long Beach, California. Stock orders of \$2,000.00 (US Lower 48 States and Canada), \$3,300.00 (Alaska and Hawaii), [all price net US\$], or more will be shipped Freight Prepaid Ground to a single location only. Exclusions on prepaid: 1) B20000-A, -B, -C, -D, -E 1932 5W Body, Bronco Hood #110460, 110461, 110462 and C-10 Bed #110839 items always ship freight collect. 2) Express NDA and 2-day orders, Special Net Pricing orders, and Special Quote Pricing orders ship FOB Long Beach. All drop shipment orders will be assessed a 5% processing fee. Drop shipment processing fee will be automatically added to the invoice without notice. No freight allowance or prepaid freight will be permitted for any drop shipment. All drop ship orders, regardless of order size, are FOB Long Beach, CA. A minimum order of \$50.00 is required. Orders below \$50.00 will be assessed a minimum order fee of \$10.00. United Pacific reserves the right to select the carrier of our choice. Freight paid orders do not include extra services such as liftgate fee.

# TERMS AND WARRANTY

## Will Call Orders

Will Call orders can be picked up in 1-3 days after placing the order. Dealers will receive their scheduled pick-up time in the order confirmation. Dealers should always call ahead to confirm when order will be ready. Sorry no same-day pick-up allowed. Will Call hours are 8:30AM – 4:00PM PST.

## Shipping Policy

### International Shipments

Shipments to locations outside the continental United States will be shipped to the dealer's shipping agent or broker within the continental United States in accordance with the US freight policy. International dealers will be responsible for the duties and taxes of their respective country.

### Express Orders

All express orders, such as Next Day, Second Day, 3 Day Service & Will Call, must be emailed, faxed, or sent via EDI. Order confirmation will be sent to the dealer for final approval. If confirmation is not received, please contact UPI to ensure your order was received. Dealers are required to sign off on express orders and send confirmation back to UPI. Cut off for express order is 10:00AM PST (Pacific Standard Time). Express orders received after 10:00AM PST will ship the next business day. Please contact UPI to confirm projected shipping date or will call time. Due to the high cost of express shipments, dealer may request UPI to notify them of freight charges. If dealer does not request confirmation, UPI will ship the express order.

### Drop Shipments

All drop shipment orders will be assessed a 5% handling fee and will be automatically added to the invoice without notice. All drop shipment orders must be emailed, faxed, or sent via EDI. No freight allowance or prepaid freight will be permitted for any drop shipment; thus, all drop ship orders regardless of order size, are FOB Long Beach, CA.

## Claims

### General Policy

All claims (Shortage, Mis-Shipped, Damage, Overage, Dealer Error & Billing Error) must be submitted to UPI within 3 business days of the receipt of shipment. Claims submitted beyond 3 business days of the receipt of shipment will be voided by UPI.

On all shipments, the person who signs and receives the shipment is responsible for noting on the Bill of Lading, in writing, whether any boxes arrived damaged or shorted. Failure to do so will void all claim rights between all parties. UPI will have no recourse against the trucking company if dealer does not note any damages or shortages on the Bill of Lading.

The dealer's receiving department must count and sign for the exact number of boxes received. Failure to follow the above instructions will void all claim rights between all parties.

### Shortages / Mis-Ships / Damages

While UPI strives to fill every order with 100% accuracy, on occasion an item may get shipped in error or get damaged during shipping. In the event this occurs, please follow the process below. Note: This type of claim must be reported to UPI within three (3) business days of receiving the order.

1. Contact the United Pacific office to initiate the claim. To make it easy for you we have two acceptable methods for requesting the claim: By e-mail : [returns@upauto.com](mailto:returns@upauto.com) OR By fax : (888) 986-5988

**Note** - To ensure you receive a timely credit, we cannot accept claim requests by phone.

2. You will be required to provide the following information:

- Your business name
- Contact name and telephone number (in case we have questions)
- Date the order was received
- A copy of the Packing List / Invoice noting the item number and quantity that was shipped in error or damaged during shipping.
- Special instructions you have for us.

3. UPI will send a return label so you can ship the items back.

4. Once we receive the miss-shipped/damaged item(s) a credit will be issued to your account on the next billing cycle. Shortages will be credit to the Dealers' account, unless dealer would like the shortages replaced.

**Overages:** UPI strives to provide our dealers with the best dealer service and products, in turn we would greatly appreciate any help from dealer in notifying UPI of any shipping overages. Dealers will be offered the option of retaining the merchandise or returning the merchandise to UPI at UPI's expense. If the items are to be returned, an RMA number and return shipping label will be provided.

**Dealer Errors:** Any item or quantity ordered in error by the dealer may be returned by contacting UPI for a RMA number.

1. We have two acceptable methods for requesting the RMA:

By e-mail : [returns@upauto.com](mailto:returns@upauto.com) OR By fax : (888) 986-5988

**Note** - To ensure you receive a timely credit, we cannot accept claim requests by phone.

2. You will be required to provide the following information:

- Your business name
- Contact name and telephone number (in case we have questions)
- A list of the items number and quantity ordered in error
- Special instructions you have for us.

3. UPI will review the request to ensure the products are within the return period.

4. Once we have validated the request, United Pacific will issue an RMA number to the dealer. In issuing the RMA approval, the following conditions will apply:

- Returned items are subject to a 20% re-stocking fee.
- Return shipping costs are the responsibility of the dealer.
- Items must not have any retail/price sticker on exterior package/box/card or they will be returned to the dealer at dealer's expense and no credit given.
- Items must be in good condition with original packaging intact, unblemished and in re-sellable condition, or they will be returned to the dealer at dealer's expense and no credit given.
- Allow up to 30 days for the credit to be issued from the time the returned items are received.

# TERMS/RETURNS

## Billing Errors

Billing errors should be reported to UPI within 3 business days of invoice receipt. Dealers are asked to provide the invoice number, part number, and quantities in question. Once verified, UPI will issue a credit or an invoice for the difference in billing error.

## Warranty

### General Policy

UPI offers a NO HASSLE WARRANTY RETURN policy. Warranty claims can only be submitted through an authorized UPI Distributor. UPI warranty is not transferable and applies to the original installation and purchase only. UPI warranty varies by product and each item's warranty period is stated on UPI's product web page. In no event shall UPI be liable for incidental or consequential damages, nor shall UPI be liable for any claims or damages arising out of or connected with the UPI warranty which exceed the purchase price of the products. There are no warranties, expressed or implied (including any warranty of merchantability or fitness) that extend beyond this warranty. The warranty does not apply to costs associated with the loss of use of the product, loss of time, inconvenience, commercial loss, incidental or consequential damages. The warranty does not apply to products which are damaged or made defective by faulty or incorrect installation. UPI reserves the right to alter the designs of products without assuming any obligation to modify previously manufactured products and will only replace warranted products with redesigned products.

Warranty does not apply to merchandise that has been drilled, cut, welded, modified in any way or installed contrary to normal installation and usage. In addition, UPI cannot be held liable for damages caused by road hazards, accidents, misuse, neglect, water intrusion, abuse or corrosive environments including acid washes and highway snow/ice chemicals which can cause discoloration and corrosion in aluminum, chrome, stainless steel and light products. UPI reserves the right to credit returned merchandise at the initial purchase price or at the current selling price, whichever price ever is lower.

### Aluminum / Chrome / Stainless Steel Products

Aluminum, chrome, and stainless steel products carry either a limited 6 month warranty, or a limited 1 year warranty (from invoice date) against defects in material or workmanship. Check the product page on our website for specific warranty period.

All Grill Guards (Item # 80000): A) Stainless Steel Materials and factory workmanship of the product itself carry a Limited Lifetime warranty. B) The Stainless steel polish and finish has a 12 month warranty. C) This warranty is provided only to the original purchaser/consumer, and on the original installation. Warranty is not transferable. Product failure or breakage due to accident/wreck or improper installation is not covered.

All mounting kits (Item # 80001, 80002, 80003, 80004, 80005): A) Steel Materials and factory workmanship on the sub-assembly bracket are Lifetime warranty. B) The painted or zinc finish has a 12 month warranty. C) Any ancillary components and parts (e.g. washers, bolts, spacers, etc.) which are not part of the sub-assembly, carry a 12 month warranty. D) This Warranty is provided only to the original purchaser/consumer, and on the original installation. Warranty is not transferable. Product failure or breakage due to accident/wreck or improper installation is not covered.

### Train Horns/Whistles

UPI will not warranty damages or discolorations caused by road hazards, accidents, misuse, or corrosive chemicals, including, acid washes and highway snow/ice solvents. Corrosive chemicals will cause discoloration. UPI will only warranty horns mounted horizontally behind the CAB/SLEEPER on the frame deck. UPI will NOT warranty horns mounted upside down or underneath of the truck. Mounting horns upside down or underneath the truck will subject the horns to road hazards & debris. This product is intended solely for the purpose of Off-road use. Check federal laws and/or regulations in your state, county, and/or municipality regarding installation and use of this product.

## Lighting Products

### Incandescent Lighting

All incandescent lighting products carry a limited 12 month warranty (from invoice date) against defects in material or workmanship. The limited 12 month warranty does not apply to several applications, such as, buses, construction equipment, and off road vehicles.

### LED Lighting

All LED lighting products carry a specific Limited Warranty (from invoice date) against defects in material or workmanship.

- LED with vehicle specific application is limited lifetime warranty to an original purchaser with receipt. Examples of lifetime warranty product: CTL5720LED CTL5720LED for 1957 Chevy, FTL3201LED-L for 1932 Ford.
- LED Marker, 2", 2-1/2", 4", 7", Oval & Square Lights - Varies from 2 years to 10 years to Limited Lifetime, depending on specific item. The housing, bezel or mounting base on any light made from Chrome/Stainless carries a 6 month limited warranty.
- LED Cab Lights and Kits, Double/Single Stud Turn Signal and PB/ KW/FL/VL or non-make Turn Signals and any/all Strip Lights - Varies from 2 years to 10 years to Limited Lifetime, depending on specific item. The housing, bezel or mounting base on any light made from Chrome/Stainless carries a 6 month limited warranty.
- LED Beacon, Driving, Headlights, Work & Warning Lights - Varies from 6 months to 3 years. The housing, bezel or mounting base on any light made from Chrome/Stainless carries a 6 month limited warranty.
- All LED Accessory Lights (Honda, Stainless Steel Double/Single face Lights, Interior Lights, License Plate Lights, and any Accent Lights. The housing, bezel or mounting base on any light made from Chrome/Stainless carries a 6 month limited warranty.
- For any product that contains any type of light or LED, whether it is a stand alone light or LED, or part of a larger assembled item (e.g.. Rear light panel), modifying electrical wiring, sockets, lighting pigtails and any electrical connection from the original configuration will void the warranty of both wiring, pigtail and the light or LED unit and cannot be warranted.
- NOTE: Dealers are responsible for shipping charges on warranty replacement items (Exemption: UP will cover shipping cost on Dropship replacement orders the first 12 months of original purchase date).

## Returns

### General Policy

All returns must be authorized by UPI. All return requests must be faxed or e-mailed (returns@upauto.com). A RMA number (Return Merchandise Authorization Number) will be provided. Returns not possessing a valid RMA number are subject to rejection and will be returned to sender at the dealer's expense. All dealers are encouraged to use the Warranty RMA Claim Form.

### Defective Goods / Warranty Return

UPI offers our dealers a No Hassle Warranty Return. Please follow the instructions below for requesting a RMA for defective goods:

1. If any warranty issues occur, simply contact the UPI for RMA number. To make it easy for you we have three acceptable





# PRODUCT INDEX

ITEM #	PAGE #	ITEM #	PAGE #	ITEM #	PAGE #	ITEM #	PAGE #	ITEM #	PAGE #
10862	142	31705	37	32662	40	34824	140	36550	160
10863	142	31707	39	32663	40	34825	140	36591	161
10864	142	31710	39	32668	34	34826	140	36592	161
10867	142	31711	39	32670	35	34827	140	36593	161
31084	12	31725	39	32675	36	34841	139	36594	161
31087	18	31726	39	32676	36	34842	139	36595	161
31088	22	31734	38	32677	35	34843	139	36596	161
31089	22	31735	38	32681	34	34844	139	36597	161
31120	17	31737	38	32682	34	34845	139	36598	161
31150	20	31738	38	32683	35	34846	139	36600	141
31151	20	31740	38	32684	35	34847	139	36601	141
31152	20	31741	38	32689	36	34848	139	36602	141
31153	20	31752	41	32690	36	34849	139	36603	141
31169	19	31753	41	32691	35	34850	139	36604	144
31200	9	31755	37	32695	33	34851	139	36675	135
31201	16	31758	31	32696	33	34852	139	36833	137
31202	16	31767	41	32744	33	35887	15	36843	141
31237	19	31768	41	32745	33	35888	15	36844	141
31238	19	31770	37	32760	33	36443	157	36859	135
31247	13	31771	37	32761	33	36444	157	36860	135
31248	8	31773	31	32762	32	36445	157	36899	143
31249	18	32035	26	32763	29	36446	146	36904	42
31259	15	32043	26	32766	31	36447	146	36917	159
31267	15	32047	26	32767	31	36448	146	36918	159
31274	22	32059	28	32769	32	36449	24	36919	159
31275	22	32326	136	32770	32	36450	17	36920	159
31284	14	32329	136	32771	29	36452	12	36927	42
31285	14	32425	27	32774	31	36465	158	36928	158
31289	10	32429	27	32775	31	36466	158	36930	158
31297	17	32437	27	32777	32	36467	158	36931	158
31355	11	32441	27	33010	137	36468	42	36932	157
31358	21	32452	29	34122	18	36469	157	36934	157
31359	21	32453	29	34125	21	36470	157	36935	157
31365	19	32456	30	34131	23	36471	157	37151	140
31368	24	32457	30	34132	23	36472	152	37153	140
31369	24	32464	30	34133	23	36473	152	37154	140
31372	43	32465	30	34134	23	36474	152	37308	136
31373	24	32468	29	34205	163	36475	152	37586	153
31374	24	32469	29	34222	43	36476	152	37587	153
31375	22	32480	30	34235	163	36477	152	37588	153
31376	22	32481	30	34263	43	36478	152	37623	143
31378	13	32508	26	34263	163	36479	152	37624	143
31379	13	32509	26	34264	43	36480	151	37637	148
31391	10	32511	34	34264	163	36481	151	37638	148
31396	21	32512	34	34265	163	36482	151	37639	148
31397	21	32519	34	34266	164	36483	151	37640	148
31458	9	32520	34	34800	164	36496	152	37659	143
31459	9	32557	27	34801	164	36497	151	37660	143
31496	8	32558	27	34802	164	36498	151	37800	160
31513	11	32559	27	34803	164	36504	161	37801	160
31514	11	32639	41	34804	164	36512	42	37802	160
31555	41	32653	40	34815	164	36513	42	37803	160
31570	28	32654	40	34817	164	36541	149	37940	147
31571	28	32655	26	34820	140	36543	160	37941	147
31574	37	32659	28	34821	140	36545	160	37942	147
31575	37	32660	40	34822	140	36547	160	37943	147
31704	37	32661	40	34823	140	36549	160	37946	149

# PRODUCT INDEX

ITEM #	PAGE #
37947	149
37948	149
37949	149
37954	143
37957	143
37961	63
37961	137
38005	146
38021	138
38272	159
38273	159
38274	159
38276	159
38277	159
38288	159
38343	159
38344	159
38345	159
38346	159
38348	159
38375	134
38376	134
38377	134
38379	134
38380	134
38389	134
38436	133
38437	133
38438	133
38439	133
38440	133
38441	133
38442	133
38443	133
38444	132
38445	132
38446	132
38447	132
38450	138
38451	138
38453	138
38454	138
38492	131
38493	131
38494	131
38496	131
38497	131
38498	131
38565	161
38566	161
38567	161
38568	161
38570	161
38571	161
38595	132
38597	132
38812	112

ITEM #	PAGE #
38820	131
38824	132
38840	136
38841	136
38842	136
38843	136
38853	136
38855	136
38856	136
38897	158
38898	158
38899	158
38931	143
38936	143
38942	146
38943	146
38944	146
38945	146
38946	145
38947	145
38948	145
38949	145
39132	42
39188	135
39189	135
39192	135
39193	135
39196	135
39197	135
39306	148
39307	148
39308	148
39309	148
39314	142
39315	142
39316	142
39317	142
39318	142
39319	142
39397	151
39606	147
39607	147
39608	147
39609	147
39685	146
39686	146
39687	146
39698	147
39699	147
39743	149
39744	149
39755	150
39756	150
39757	150
39758	150
39767	141
39768	141

ITEM #	PAGE #
39769	141
39770	141
39771	141
39772	141
39773	145
39774	145
39775	145
39776	145
39781	149
39804	147
39805	147
39806	147
39862	157
39909	153
39930	153
39932	141
39933	141
39934	141
39935	141
39936	141
39937	141
40051	142
40052	142
40053	142
40055	142
50121	149
50122	149
50148	150
50149	150
50187	150
70301	142
70302	142
70303	142
86815	155
86817	155
86819	155
86821	156
86823	156
86824	156
90649	162
90651	162
90652	162
90655	163
90656	162
90660	164
110105	122
110106	123
110107	123
110108	64
110109	64
110110	46
110111	46
110126	92
110127	96
110128	119
110138	119
110139	119

ITEM #	PAGE #
110142	120
110143	120
110144	120
110145	120
110147	97
110150	107
110155	67
110156	67
110157	67
110158	67
110194	104
110195	104
110196	104
110197	104
110198	56
110199	87
110200	92
110201	92
110202	92
110203	154
110204	154
110206	55
110207	55
110213	91
110214	91
110215	92
110221	58
110253	109
110265	154
110268	79
110359	78
110360	78
110375	65
110376	65
110382	127
110404	85
110405	85
110406	137
110407	106
110409	106
110411	44
110412	44
110413	44
110414	44
110415	45
110416	45
110419	80
110420	80
110443	65
110458	73
110545	94
110546	94
110547	73
110548	73
110549	96
110583	126
110584	126

# PRODUCT INDEX

ITEM #	PAGE #	ITEM #	PAGE #	ITEM #	PAGE #	ITEM #	PAGE #
110660	106	36518B	144	C5851	60	CPL5531C	54
110661	106	36519B	144	C5860	71	CPL5557A	84
110662	106	36520B	144	C5901L	60	CPL5557C	84
110663	106	36521B	144	C5901R	60	CPL5601C	57
110750	82	36621B	138	C5902	60	CPL5702A	58
110759	119	37499B	144	C606651	87	CPL5702C	58
110760	119	37625B	143	C666702	78	CPL5801A	60
110761	119	38861B	145	C677209	93	CPL5801C	60
110762	119	38862B	145	C7031RL	81	CPL6066A	83
110763	120	38863B	145	C7031RLBD	81	CPL6367A	72
110764	120	38864B	145	C7031RR	81	CPL6367C	72
110765	86	38942B	146	C7031RRBD	81	CPL6601LED	76
110766	85	38943B	146	C7033RL	81	CPL6701LED	76
110767	86	38944B	146	C7033RLBD	81	CPL6768A	95
110768	85	38945B	146	C7033RR	81	CPL6768C	95
110772	128	38946B	145	C7033RRBD	81	CPL6970AL	95
110773	128	38947B	145	C738703	93	CPL6970AR	95
110774	127	38948B	145	CBL5311	53	CPL6970CL	95
110775	127	38949B	145	CBL5451LED	53	CPL6970CR	95
110795	87	39314B	142	CBL5511LED	55	CPL7172A	95
110796	109	39315B	142	CBL5607LED	57	CPL7172C	95
110797	110	39316B	142	CBL6051	74	CTL3336LED-R	44
110798	112	39317B	142	CBL6251LED	74	CTL3911LED	48
110804	128	39318B	142	CBL6264LED	79	CTL3911LED	48
110805	128	39319B	142	CBL6351LED	75	CTL3918LED	48
110837	127	39483B	145	CBL6366LED	69	CTL4010LED	49
110838	127	39484B	145	CBL6366LED	72	CTL4010LED-AS	49
110843	94	39485B	145	CBL6451LED	75	CTL4053LED-L	47
110844	94	39512B	135	CBL6551LED	76	CTL4053LED-LBD	47
110872	102	39644B	145	CBL6667LED	78	CTL4053LED-R	47
110873	102	39645B	145	CBL6704LED	64	CTL4053LED-RBD	47
110890	101	39684B	146	CBL6711LED	69	CTL4053LL	47
110891	101	39685B	146	CBL6712LED	69	CTL424803	50
110892	101	39686B	146	CBL6851LED	77	CTL424804	50
110893	101	39687B	146	CBL6852LED	77	CTL424805	50
110894	101	39773B	145	CBL6853LED	63	CTL4248LED	49
110895	101	39774B	145	CBL6853LED	65	CTL4248LEDBD	50
111036	54	39775B	145	CBL6951LED	69	CTL4901LED	51
111037	54	39776B	145	CBL7101LED-L	68	CTL4950LED	143
111108	96	39994B	153	CBL7101LED-R	68	CTL4950LED-ALS	51
111109	96	39995B	154	CBL7201LED-L	68	CTL4950LED-ARS	51
111110	92	90650A	162	CBL7201LED-R	68	CTL5152LED	52
111112	94	A1060LED	108	CDL555701	58	CTL5152LED-AS	52
111113	93	A5022BCL	33	CDL555701-AS	58	CTL5310	53
111114	65	A5022SSE	33	CML6872A	97	CTL5312	53
111115	67	C3704RL	45	CML6872R	97	CTL5401LED	53
111116	64	C3704RLBD	46	CPL3901AB	48	CTL5408LED	54
111117	73	C3704RR	45	CPL4753A	82	CTL5510LED	55
111118	66	C3704RRBD	46	CPL4753A-AC	82	CTL5606A	52
111119	68	C4009G	81	CPL4753A-AS	82	CTL5606LED	52
111120	73	C4061RL	49	CPL4753C	82	CTL5606W	52
111121	47	C4061RLBD	50	CPL4753C-AC	82	CTL5608LED	57
111122	67	C4062CR	49	CPL4753C-AS	82	CTL5701LED	71
111123	66	C4062RRBD	50	CPL5153C	84	CTL5720LED	56
111127	68	C495004	51	CPL5362A	71	CTL5859C	84
34217B	43	C515301	84	CPL5362C	71	CTL5859LED	84
36517B	144	C555911-3	85	CPL5531A	54	CTL5860LED	71

# PRODUCT INDEX

ITEM #	PAGE #	ITEM #	PAGE #	ITEM #	PAGE #	ITEM #	PAGE #
CTL5860LED	72	CTL7073LED-L	65	FTL2831LED6-AR	98	FTL424803	117
CTL5901LED	59	CTL7073LED-R	65	FTL2831LED6-BAL	99	FTL4248LED	116
CTL5902LED-L	60	CTL7101LED-L	68	FTL2831LED6-BAR	99	FTL4248R	117
CTL5902LED-R	60	CTL7101LED-R	68	FTL2831LED6-L	98	FTL4748A	118
CTL5903-1	59	CTL7201LED-L	68	FTL2831LED6-R	98	FTL4748C	118
CTL5903R	59	CTL7201LED-R	68	FTL2831RA-AL	98	FTL4950LED	118
CTL5911LED	59	CTL7387LED-L	93	FTL2831RA-AR	98	FTL4950LED-AS	118
CTL5913LED	59	CTL7387LED-R	93	FTL2831RA-BAL	99	FTL5356LLB	128
CTL6061LED	74	CTL7582LED	70	FTL2831RA-BAR	99	FTL6106LED	124
CTL6066BC	86	CTL8010C	70	FTL2831RA-L	98	FTL6401LED	122
CTL6066BR	86	CTL8010LED	70	FTL2831RA-R	98	FTL6406LED	124
CTL6066C	86	CTL8490LED	70	FTL2831RA6-AL	98	FTL6411LED	122
CTL6066FC	87	CTL9096LED	70	FTL2831RA6-AR	98	FTL6701LED	123
CTL6066FSC	87	DTL6801LED	130	FTL2831RA6-BAL	99	FTL6772LED-L	126
CTL6066FSLED	87	F3201LED	103	FTL2831RA6-BAR	99	FTL6772LED-PR	126
CTL6066FSR	87	F3301-LED	103	FTL2831RA6-L	98	FTL6772LED-R	126
CTL6066LED	86	F383901	109	FTL2831RA6-R	98	FTL6901LED	123
CTL6066SC	86	F383904	108	FTL3201LED-AL	105	S1005	129
CTL6066SR	86	F383904BD	111	FTL3201LED-AR	105	S2005LED	16
CTL6201LED	74	F383905	110	FTL3201LED-L	104	S2007LED	154
CTL6264LED	79	F42802	116	FTL3201LED-R	104	S2007LED-A	154
CTL6301LED	75	F42805	117	FTL3336CB-L	107	S2007LED-W	154
CTL6401LED	75	F49501	118	FTL3336CB-R	107	S2008LED	153
CTL6402LED-L	66	F49503	118	FTL3336L	105	S2010LED	13
CTL6402LED-R	66	F49504	118	FTL3336L-BK	105	STL1001LED	129
CTL6501C	76	F6411	124	FTL3336LED-AL	105	STL1004LED	129
CTL6501LED	76	F6411-1	124	FTL3336LED-ALB	105	STL1006LED	129
CTL6521LED-L	66	F6412	124	FTL3336LED-AR	105	STL1010LED	130
CTL6521LED-R	66	F677203	126	FTL3336LED-ARB	105	STL1010LED-AS	130
CTL6667LED	78	FPL2829LED	103	FTL3336LED-L	106	STL1012LED	129
CTL6701C	66	FPL3031LED	103	FTL3336LED-R	106	VTL6870LED	130
CTL6701C	66	FPL3232LED	103	FTL3336R	105		
CTL6701LED	66	FPL3334LED	103	FTL3336R-BK	105		
CTL6701LED	66	FPL4001LED	113	FTL3701LED-L	107		
CTL6703LED	63	FPL4002LED	113	FTL3701LED-R	107		
CTL6704LED	64	FPL4101A	116	FTL3711R	107		
CTL6721C	91	FPL4111A	116	FTL3711RC	107		
CTL6721LED	91	FPL6401LED	122	FTL383903	110		
CTL6721SEQ	91	FTL1156-PLUG	164	FTL383903ZR	111		
CTL6772LED	93	FTL1157-PLUG	164	FTL383905ZR	110		
CTL6801C	77	FTL2831BD-AL	99	FTL383907	108		
CTL6801LED	77	FTL2831BD-AR	99	FTL383908	111		
CTL6802LED	77	FTL2831BD-BAL	99	FTL383909	112		
CTL6803C	64	FTL2831BD-BAR	99	FTL383910	112		
CTL6803LED	63	FTL2831BD-L	99	FTL3839LED	109		
CTL6803LED	63	FTL2831BD-MAL	102	FTL3839NT-BD	111		
CTL6804LED	69	FTL2831BD-MAR	102	FTL3839NTLED	108		
CTL6805LED	63	FTL2831BD-R	99	FTL4004-2	114		
CTL6821LED-L	67	FTL2831LED-AL	98	FTL4004LED	114		
CTL6821LED-R	67	FTL2831LED-AL	102	FTL4004RB	114		
CTL6826LED	79	FTL2831LED-AR	98	FTL4005LED	113		
CTL6869LED-L	73	FTL2831LED-AR	102	FTL4006LED	115		
CTL6869LED-R	73	FTL2831LED-BAL	99	FTL4011LED	115		
CTL6901LED-L	63	FTL2831LED-BAR	99	FTL4014LED	114		
CTL6901LED-R	63	FTL2831LED-L	98	FTL4101LED	115		
CTL7072LED-L	73	FTL2831LED-R	98	FTL414103	115		
CTL7072LED-R	73	FTL2831LED6-AL	98	FTL4248-1	117		

### LED Headlights



### LED Tail Lights



### LED Parking/Signal Lights



### LED Side Markers & Accessories



### LED Misc. Lights



### LED Accessory Lights



**United Pacific**

UPauto.com | T 866.327.5288 | F 888.986.6088

© 2023 United Pacific Industries. All rights reserved. Products not shown to scale. Specifications subject to change without notice.

**ACLED7**

Classic LED Lighting Product Catalog 7th Edition



710270065691